



SERVICE MANUAL

HYPER INVERTER PACKAGED AIR-CONDITIONERS (Split system, air to air heat pump type)

CEILING CASSETTE-4 WAY TYPE

Single type

FDT71VNXWVH

Twin type

FDT71VNXWPVH

DUCT CONNECTED-HIGH STATIC PRESSURE TYPE

Single type

FDU71VNXWVH

CEILING SUSPENDED TYPE

Single type

FDE71VNXWVH

Twin type

FDE71VNXWPVH

V Multi System

(OUTDOOR UNIT) (INDOOR UNIT)

FDC71VNX-W FDT40VH FDE40VH

CEILING CASSETTE-4 WAY COMPACT TYPE

Twin type

FDTC71VNXWPVH

DUCT CONNECTED-LOW/MIDDLE STATIC PRESSURE TYPE

Single type

FDUM71VNXWVH

Twin type

FDUM71VNXWPVH

WALL MOUNTED TYPE

Single type

SRK71VNXWZR

TABLE OF CONTENTS

1. HYPER INVERTER PACKAGED AIR-CONDITIONERS	2
2. V MULTI SYSTEM	147

1. HYPER INVERTER PACKAGED AIR-CONDITIONERS

CONTENTS

1.1 OUTLINE OF OPERATION CONTROL BY MICROCOMPUTER	4
1.1.1 Remote control (Option parts)	4
1.1.2 Operation control function by the wired remote control	9
1.1.3 Operation control function by the indoor control	12
1.1.4 Operation control function by the outdoor control	41
Model FDC71	41
(1) Determination of compressor speed (Frequency)	41
(2) Compressor start control	42
(3) Compressor soft start control	42
(4) Outdoor fan control	43
(5) Defrost operation	44
(6) Protective control/anomalous stop control by compressor's number of revolutions	45
(7) Silent mode	48
(8) Test run	48
(9) Pump-down control	49
1.2 MAINTENANCE DATA	50
1.2.1 FDT, FDTC, FDU, FDUM, FDE series	50
1.2.1.1 Diagnosing of microcomputer circuit	50
(1) Selfdiagnosis function	50
(2) Troubleshooting procedure	53
(3) Troubleshooting at the indoor unit	53
(4) Troubleshooting at the outdoor unit	60
(5) Check of anomalous operation data with the remote control	65
(6) Power transistor module (Including the driver PCB) inspection procedure	67
(7) Inverter checker for diagnosis of inverter output	68
(8) Outdoor unit control failure diagnosis circuit diagram	69
1.2.1.2 Troubleshooting flow	70
(1) List of troubles	70
(2) Troubleshooting	71
1.2.2 SRK series	120
(1) Cautions	120
(2) Items to check before troubleshooting	120
(3) Troubleshooting procedure (If the air-conditioner does not run at all)	120
(4) Troubleshooting procedure (If the air-conditioner runs)	121
(5) Self-diagnosis table	122
(6) Service mode (Trouble mode access function)	123

(7) Inspection procedures corresponding to detail of trouble	131
(8) Phenomenon observed after short-circuit, wire breakage on sensor ...	133
(9) Checking the indoor electrical equipment	133
(10) How to make sure of wireless remote control	135
(11) Inspection procedure for blown fuse on the indoor unit PCB	135
1.3 ELECTRICAL WIRING	136
(1) Indoor units	136
(2) Outdoor unit	143
1.4 PIPING SYSTEM	144

1.1 OUTLINE OF OPERATION CONTROL BY MICROCOMPUTER

1.1.1 Remote control (Option parts)

(1) Wired remote control

Model RC-EX3A

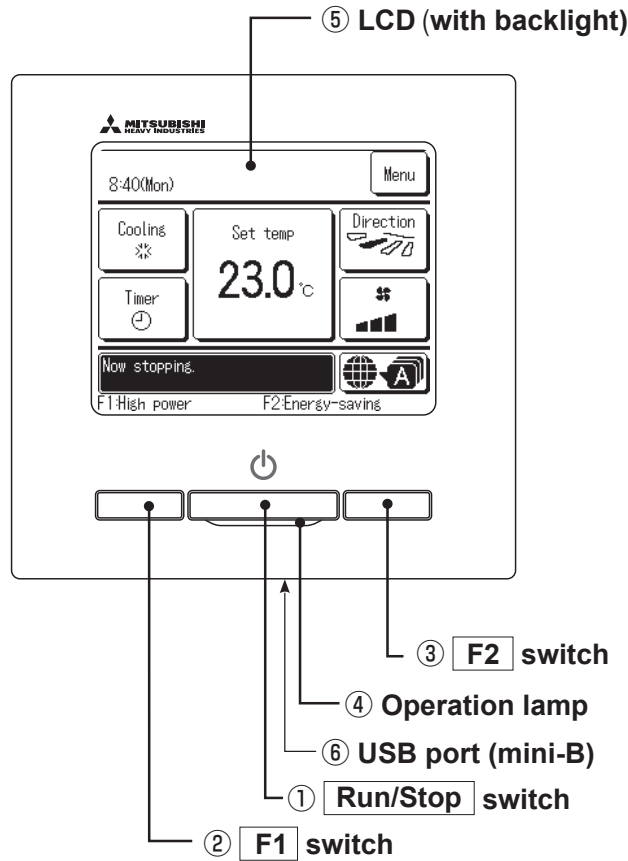

Touch panel system, which is operated by tapping the LCD screen with a finger, is employed for any operations other than the ①Run/Stop, ②F1 and ③F2 switches.

① Run/Stop switch

One push on the button starts operation and another push stops operation.

If the backlight is ON setting, when the screen is tapped while the backlight is turned off, the backlight only is turned on. (Operations with switches ①, ② and ③ are excluded.)

② F1 switch ③ F2 switch

This switch starts operation that is set in F1/F2 function change.

⑥ USB port

USB connector (mini-B) allows connecting to a personal computer.

④ Operation lamp

This lamp lights in green (yellow-green) during operation. It changes to red (orange) if any error occurs.
Operation lamp luminance can be changed.

For operating methods, refer to the instruction manual attached to the software for personal computer (remote control utility software).

⑤ LCD (with backlight)

A tap on the LCD lights the backlight.
The backlight turns off automatically if there is no operation for certain period of time.
Lighting period of the backlight lighting can be changed.

Note(1) When connecting to a personal computer, do not connect simultaneously with other USB devices.
Please be sure to connect to the computer directly, without going through a hub, etc.

Model RC-E5

The figure below shows the remote control with the cover opened. Note that all the items that may be displayed in the liquid crystal display area are shown in the figure for the sake of explanation. Characters displayed with dots in the liquid crystal display area are abbreviated.

The figure below shows the remote control with the cover opened.

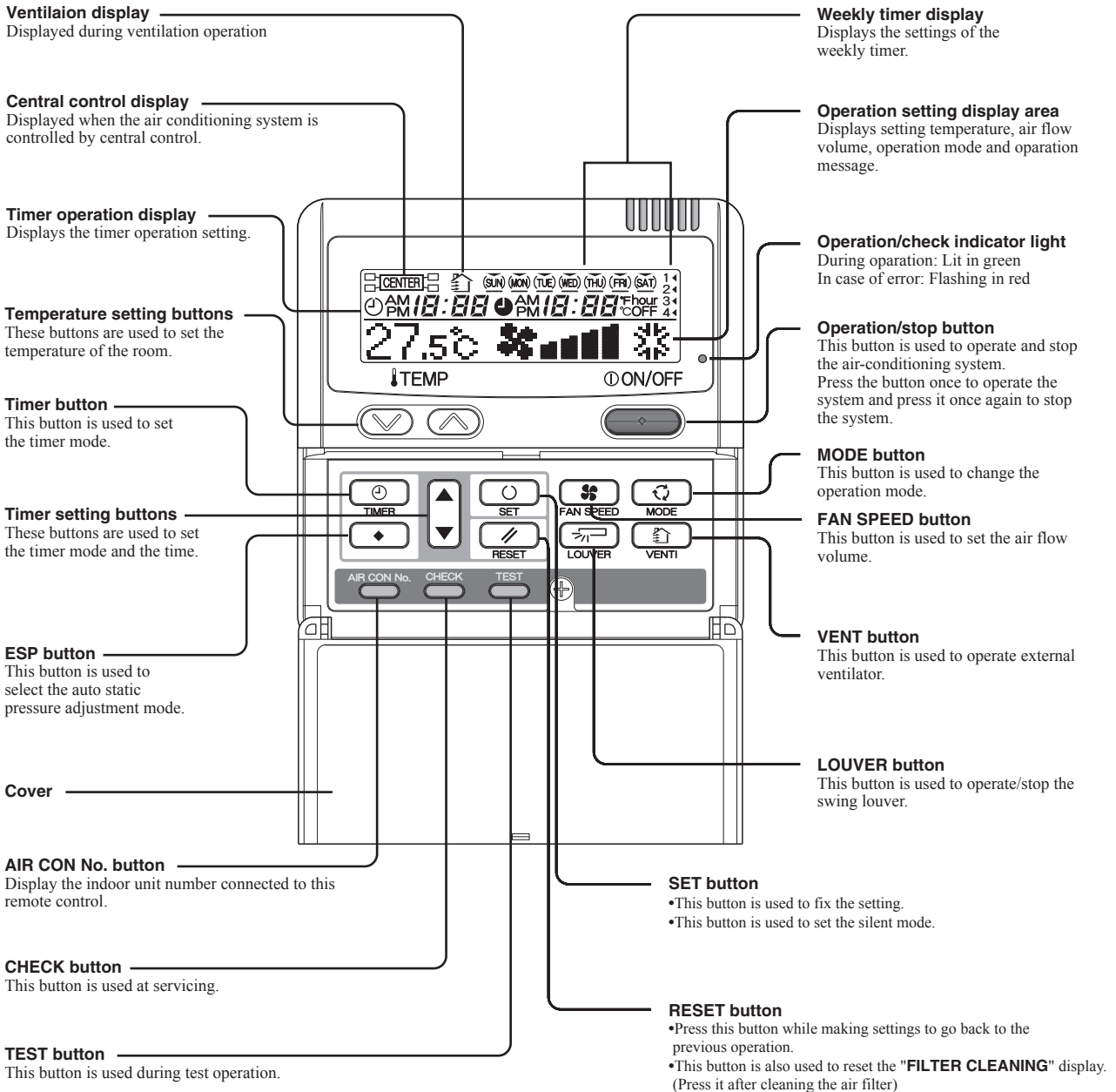

* All displays are described in the liquid crystal display for explanation.

(2) Wireless remote control
RCN-E2 (Except SRK series)

Indication section

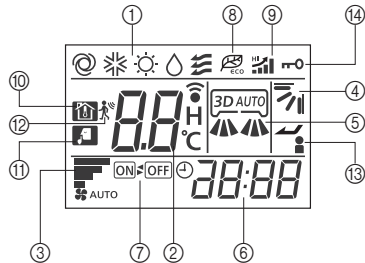

①	OPERATION MODE display	Indicates selected operation mode.
	SET TEMP display	Indicates set temperature.
②	SLEEP TIMER time display	Indicates the amount of time remaining on the sleep timer.
	Indoor function setting number display	Indicates the setting number of the indoor function setting.
③	FAN SPEED display	Indicates the selected air flow volume.
④	UP/DOWN AIR FLOW display	Indicates the up/down louver position.
⑤	LEFT/RIGHT AIR FLOW display	Indicates the left/right louver position.
⑥	Clock display	Indicates the current time. If the timer is set, the ON TIMER and OFF TIMER setting times are indicated.
⑦	ON/OFF TIMER display	Displayed when the timer is set.
⑧	ECO mode display	Displayed when the energy-saving operation is active.
⑨	HI POWER display	Displayed when the high power operation is active.
⑩	NIGHT SETBACK display	Displayed when the home leave mode is active.
⑪	SILENT display	Displayed when the silent mode control is active.
⑫	Motion sensor display	Displayed when the infrared sensor control(motion sensor control) is enabled.
⑬	Anti draft setting display	Displayed when anti draft setting is enabled.
⑭	Child lock display	Displayed when child lock is enabled.

Operation section

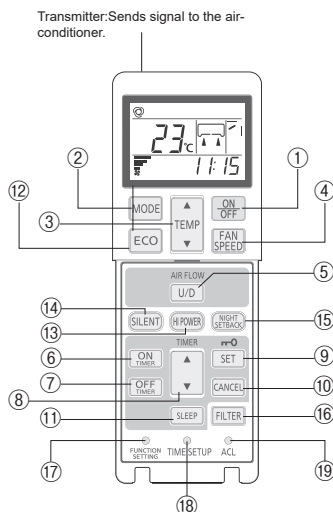

①	ON/OFF button	When this is pressed once, the air-conditioner starts to operate and when this is pressed once again, it stops operating.
②	MODE button	Every time this button is pressed, displays switch as below
③	TEMP button	Change the set temperature by pressing ▲ or ▼ button.
④	FAN SPEED button	The fan speed is switched in the following order: 1-speed → 2-speed → 3-speed → 4-speed → AUTO → 1-speed.
⑤	U/D button	Used to determine the up/down louver position.
⑥	ON TIMER button	Used to set the ON TIMER.
⑦	OFF TIMER button	Used to set the OFF TIMER.
⑧	SELECT button	Used to switch the time when setting the timer or adjusting the time. Used to switch the settings of the indoor function.
⑨	SET button	Used to determine the setting when setting the timer or adjusting the time. Used to determine the settings of the indoor function. When press and hold SET button ,Child Lock is enabled.
⑩	CANCEL button	Used to cancel the timer setting.
⑪	SLEEP button	Used to set the sleep timer.
⑫	ECO button	Pressing this button starts the energy-saving operation. Pressing this button again cancels it.
⑬	HI POWER button	Pressing this button starts the high power operation. Pressing this button again cancels it.
⑭	SILENT button	Pressing this button starts the silent mode control. Pressing this button again cancels it.
⑮	NIGHT SETBACK button	Pressing this button starts the home leave mode. Pressing this button again cancels it.
⑯	FILTER button	Pressing this button resets FILTER SIGN.
⑰	FUNCTION SETTING switch	Used to set the indoor function.
⑱	TIME SETUP switch	Used to set the current time.
⑲	ACL switch	Used to reset the microcomputer.

SRK series only

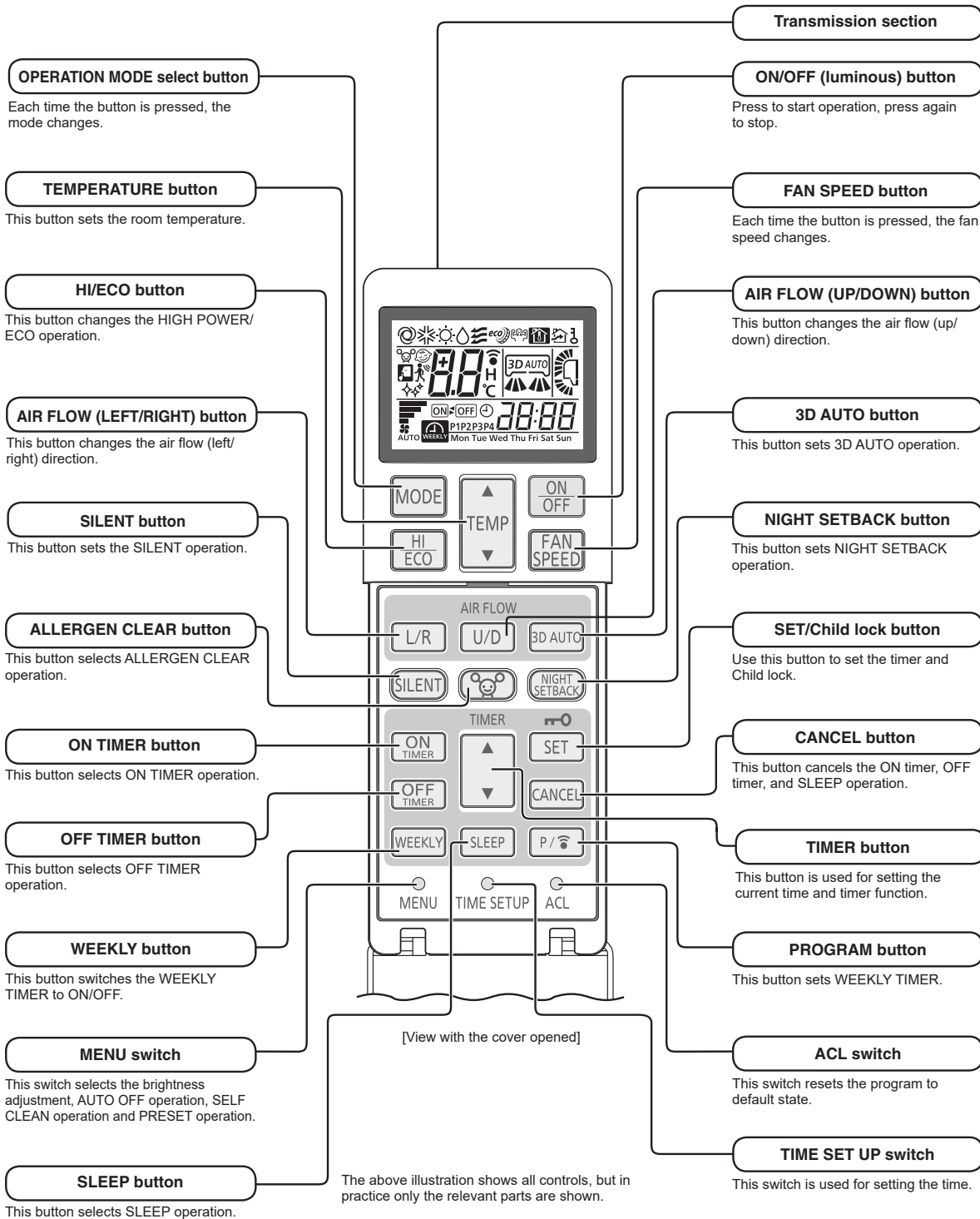

Model SRK71ZR-W

Unit display section

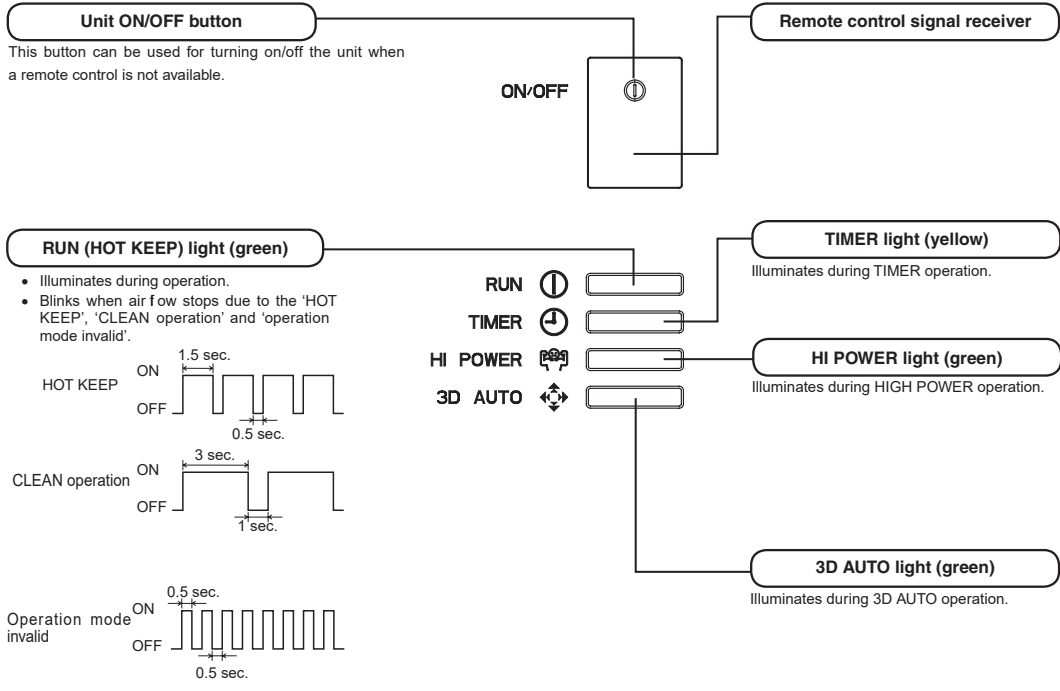

1.1.2 Operation control function by the wired remote control

● Model RC-EX3A

(1) Switching sequence of the operation mode switches of remote control

- Tap the change operation mode button on the TOP screen.
- When the change operation mode screen is displayed, tap the button of desired mode.
- When the operation mode is selected, the display returns to the TOP screen.

Icons displayed have the following meanings.

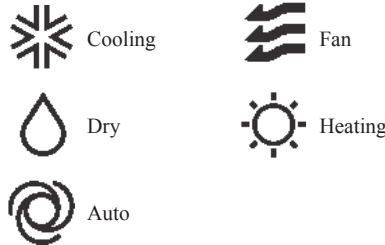

Notes(1) Operation modes which cannot be selected depending on combinations of indoor unit and outdoor unit are not displayed.

- When the Auto is selected, the cooling and heating switching operation is performed automatically according to indoor and outdoor temperatures.

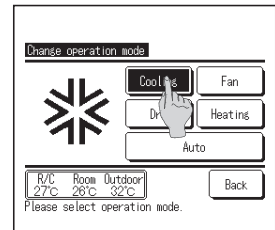
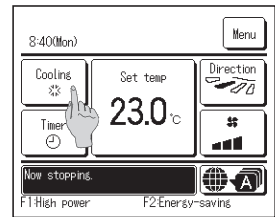

(2) CPU reset

Reset CPU from the remote control as follows.

TOP screen → Menu → Service setting → Service & Maintenance → Service password

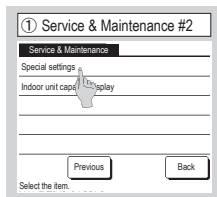

The selected screen is displayed.

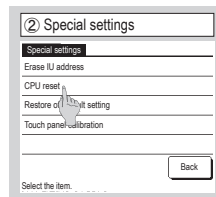

The selected screen is displayed.

CPU reset

Microcomputers of indoor unit and outdoor unit connected are reset (State of restoration after power failure).

(3) Power failure compensation function (Electric power source failure)

Enable the Auto-restart function from the remote control as follows.

TOP screen → Menu → Service setting → R/C function settings → Service password

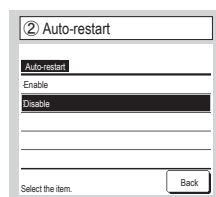
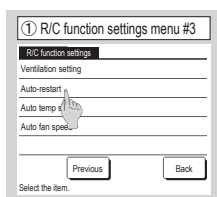

If the unit stops during operation,

Enable

It returns to the state before the power failure as soon as the power source is restored (After the end of the primary control at the power on).

Disable

It stops after the restoration of power source.

● Since the status of remote control is retained in memory always, it restarts operations according to the contents of memory as soon as the power source is restored. Although the timer mode is cancelled, the weekly timer, peak cut timer and silent mode timer operate according to the following contents:

- When the clock setting is valid : These timer settings are also valid.
- When the clock setting is invalid : These timer settings become “Invalid” since the clock setting is invalid. These timer settings have to be changed to “Valid” after the timer setting.

- Content memorized with the power failure compensation are as follows.

Note(1) Items (f) and (g) are memorized regardless whether the power failure compensation is effective or not while the setting of silent mode is cancelled regardless whether the power failure compensation is effective or not.

- (a) At power failure – Operating/stopped
If it had been operating under the off timer mode, sleep timer mode, the state of stop is memorized.
- (b) Operation mode
- (c) Air flow volume mode
- (d) Room temperature setting
- (e) Louver auto swing/stop
However, the stop position (4-position) is cancelled so that it returns to Position (1).
- (f) “Remote control function items” which have been set with the administrator or installation function settings
 (“Indoor function items” are saved in the memory of indoor unit.)
- (g) Weekly timer, peak-cut timer or silent mode timer settings
- (h) Remote control function setting

(4) Alert displays

If the following (a) to (c) appear, check and repair as follows.

(a) Communication check between indoor unit and remote control



- This appears if communications cannot be established between the remote control and the indoor unit.
Check whether the system is correctly connected (indoor unit, outdoor unit, remote control) and whether the power source for the outdoor unit is connected.

(b) Clock setting check

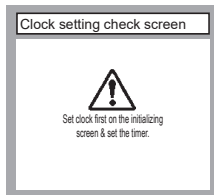

- This appears when the timer settings are done without clock setting.
Set the clock setting before the timer settings.

(c) Misconnection

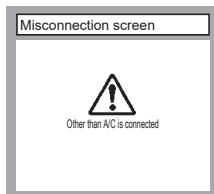

- This appears when something other than the air-conditioner has been connected to the remote control.
Check the location to which the remote control is connected.

● Model RC-E5

(1) Switching sequence of the operation mode switches of remote control

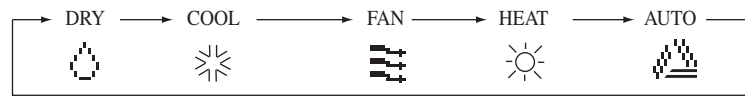

(2) CPU reset

This functions when “CHECK” and “ESP” buttons on the remote control are pressed simultaneously. Operation is same as that of the power source reset.

(3) Power failure compensation function (Electric power source failure)

- This becomes effective if “Power failure compensation effective” is selected with the setting of remote control function.
- Since it memorizes always the condition of remote control, it starts operation according to the contents of memory no sooner than normal state is recovered after the power failure. Although the auto swing stop position and the timer mode are cancelled, the weekly timer setting is restored with the holiday setting for all weekdays. After recovering from the power failure, it readjusts the clock and resets the holiday setting for each weekday so that the setting of weekly timer becomes effective.
- Content memorized with the power failure compensation are as follows.

Note (1) Items (f), (g) and (h) are memorized regardless whether the power failure compensation is effective or not while the setting of silent mode is cancelled regardless whether the power failure compensation is effective or not.

(a) At power failure – Operating/stopped

If it had been operating under the off timer mode, sleep timer mode, the state of stop is memorized. (Although the timer mode is cancelled at the recovery from power failure, the setting of weekly timer is changed to the holiday setting for all weekdays.)

(b) Operation mode

(c) Air flow volume mode

(d) Room temperature setting

(e) Louver auto swing/stop

However, the stop position (4-position) is cancelled so that it returns to Position (1).

(f) “Remote control function items” which have been set with the remote control function setting (“Indoor function items” are saved in the memory of indoor unit.)

(g) Upper limit value and lower limit value which have been set with the temperature setting control

(h) Sleep timer and weekly timer settings (Other timer settings are not memorized.)

[Parts layout on remote control PCB]

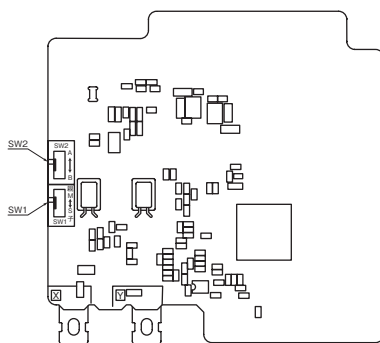

Master/ slave setting when more than one remote controls are used

A maximum of two remote controls can be connected to one indoor unit (or one group of indoor units.)

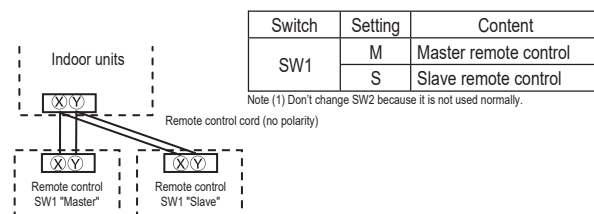

Caution

When using multiple remote controls, the following displays or settings cannot be done with the slave remote control. It is available only with the master remote control.

- ① Louver position setting (set upper or lower limit of swinging range)
- ② Setting indoor unit functions
- ③ Setting temperature range
- ④ Operation data display
- ⑤ Error data display
- ⑥ Silent mode setting
- ⑦ Test operation of drain pump
- ⑧ Remote control sensor setting

1.1.3 Operation control function by the indoor control

(I) FDT, FDTTC, FDU, FDUM, FDE series

(1) Auto operation

- (a) If “Auto” mode is selected by the remote control, the heating and the cooling are automatically switched according to the difference between outdoor air temperature and setting temperature and the difference between setting temperature and return air temperature. (When the switching of cooling mode ↔ heating mode takes place within 3 minutes, the compressor does not operate for 3 minutes by the control of 3-minute timer.) This will facilitate the cooling/heating switching operation in intermediate seasons and the adaptation to unmanned operation at stores, etc (ATM corner of bank).

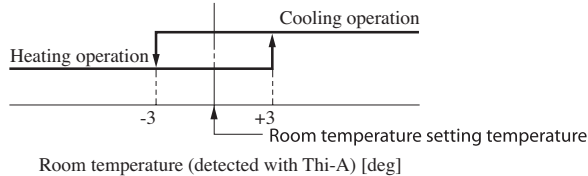

Notes (1) Temperature range of switching cooling/heating mode can be changed by RC-EX3A from ±1.0 – ±4.0.

- (2) Room temperature control during auto cooling/auto heating is performed according to the room temperature setting temperature. (DIFF: ±1 deg)
 (3) If the indoor heat exchanger temperature rises to 59°C or higher during heating operation, it is switched automatically to cooling operation. In addition, for 1 hour after this switching, the heating operation is not performed, regardless of the temperature shown at right.

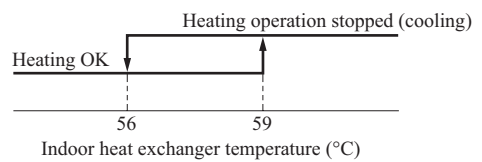

- (b) The following automatic controls are performed other than (a) above.

- (i) Cooling or heating operation mode is judged according to the conditions of the "Judgment based on Setting temperature + Cooling select temperature and Indoor return air temperature" and the "Judgment based on Outdoor temperature".

- 1) In "Setting temperature - Cooling select temperature < Indoor return air temperature" and "Outdoor temperature/Cooling < Outdoor return air temperature" ⇒ Operation mode: Cooling
- 2) "Setting temperature + Heating select temperature > Indoor return air temperature" and "Outdoor temperature/Heating > Outdoor air temperature" ⇒ Operation mode: Heating
- 3) The outdoor air temperature of the above judgment conditions is sampled at every 10 minutes.
- 4) In the range where the above cooling and heating zones are overlapped ⇒ Forced thermostat OFF

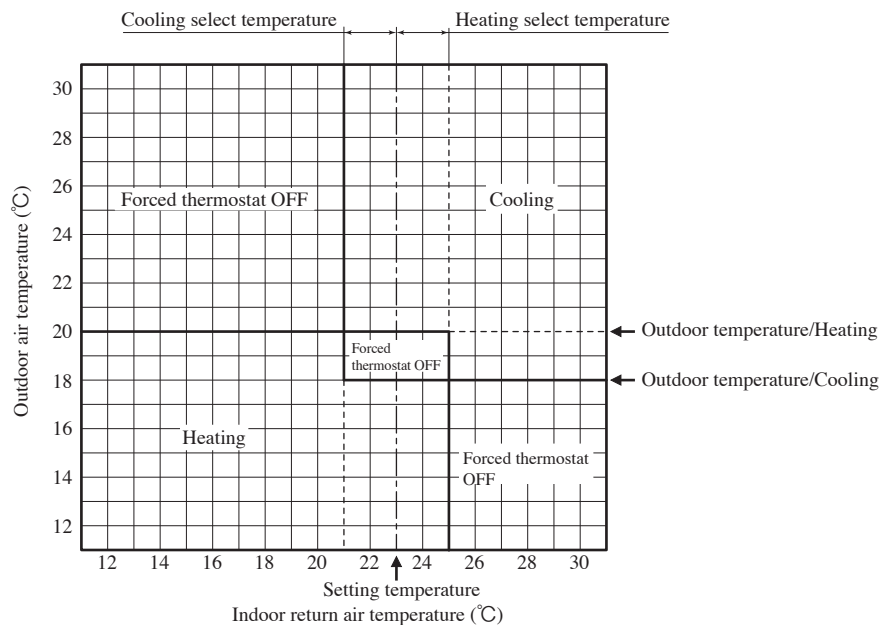

- (ii) Regardless of the setting temperature, the cooling or heating operation mode is judged according to the "Judgment based on Room temperature/Cooling or Heating and Outdoor temperature/Cooling or Heating".
 - 1) In case of "Room temperature/Cooling < Indoor return air temperature" and "Outdoor temperature/Cooling < Outdoor air temperature" ⇒ Operation mode: Cooling
 - 2) In case of "Room temperature/Heating > Indoor return air temperature" and "Outdoor temperature /Heating > Outdoor air temperature" ⇒ Operation mode: Heating
 - 3) The outdoor air temperature of the above judgment conditions is sampled at every 10 minutes.
 - 4) In the range where the above cooling and heating zones are overlapped ⇒ Forced thermostat OFF

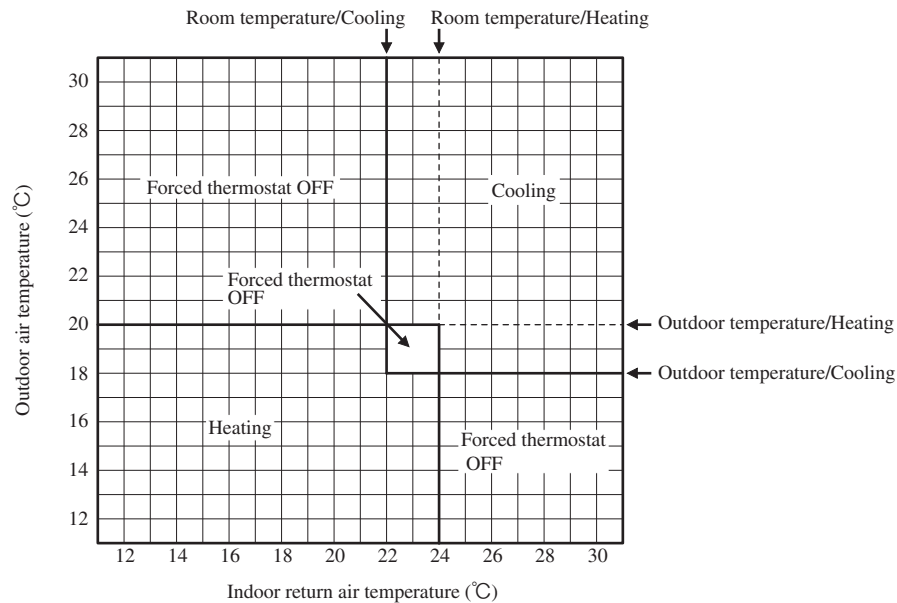

(2) Operations of functional items during cooling/heating

Operation / Functional item	Cooling		Fan	Heating			Dehumidifying
	Thermostat ON	Thermostat OFF		Thermostat ON	Thermostat OFF	Hot start (Defrost)	
Compressor	○	×	×	○	×	○	○/×
4-way valve	×	×	×	○	○	○(×)	×
Outdoor fan	○	×	×	○	×	○(×)	○/×
Indoor fan	○	○	○	○/×	○/×	○/×	○/×
Drain pump ⁽³⁾	○	× ⁽²⁾	× ⁽²⁾	○/× ⁽²⁾			Thermostat ON: ○ Thermostat OFF: × ⁽²⁾

Notes (1) ○: Operation ×: Stop ○/×: Turned ON/OFF by the control other than the room temperature control.
 (2) ON during the drain pump motor delay control.
 (3) Drain pump ON setting may be selected with the indoor unit function setting of the wired remote control.

(3) Dehumidifying (DRY) operation

(a) FDT&FDTC series

Indoor ambient temperatures and humidity are controlled simultaneously with the relative humidity sensor (HS) and the suction temperature sensor [Thi-A (or the remote control temperature sensor when it is activated)], which are installed at the suction inlet.

- (i) When the operation has been started with cooling, if there is a difference of 2°C or less between the suction and setting temperatures, the tap of indoor fan is lowered by one tap. This tap is retained for 3 minutes after changing the tap.
- (ii) After the above condition, when a difference between suction and setting temperature is lower than 3°C, and the relative humidity is high, the tap of indoor unit fan is lowered by one tap.
 When the difference between suction and setting temperature is larger than 3°C, the fan of indoor unit fan is raised by one tap. This tap is retained for 3 minutes after changing the tap.
- (iii) When relative humidity becomes lower, the indoor unit fan tap is retained.
- (iv) In case of the thermostat OFF, the indoor unit fan tap at the thermostat ON is retained.

(b) FDU, FDUM, FDE series

Return air temperature sensor [Thi-A (by the remote control when the remote control temperature sensor is enabled)] controls the indoor temperature environment simultaneously.

- (i) Operation is started in the cooling mode. When the difference between the return air temperature and the setting temperature is 2°C or less, the indoor unit fan tap is brought down by one tap. That tap is retained for 3 minutes after changing the indoor unit fan tap.
- (ii) If the return air temperature exceeds the setting temperature by 3°C during dehumidifying operation, the indoor unit fan tap is raised. That tap is retained for 3 minutes after changing the indoor unit fan tap.
- (iii) If the thermostat OFF is established during the above control, the indoor unit fan tap at the thermostat ON is retained so far as the thermostat is turned OFF.

(4) Timer operation

(a) RC-EX3A

- (i) Sleep timer
Set the time from the start to stop of operation. The time can be selected in the range from 30 to 240 minutes (in the unit of 10-minute).
Note (1) Enable the “Sleep timer” setting from the remote control. If the setting is enabled, the timer operates at every time.
- (ii) Set OFF timer by hour
Set the time to stop the unit after operation, in the range from 1 to 12 hours (in the unit of hour).
- (iii) Set ON timer by hour
Set the time to start the unit after the stop of operation, in the range from 1 to 12 hours (in the unit of hour). It is allowed also to set simultaneously the indoor temperature, operation mode, air flow rate and warm-up enabled/disabled.
- (iv) Set ON timer by clock
Set the time to start operation. The time can be set in the unit of 5-minute. This setting can be activated only once or at every time. It is allowed also to set simultaneously the indoor temperature, operation mode, air flow rate and warm-up enabled/disabled.
Note (1) It is necessary to set the clock to use this timer.
- (v) Set OFF timer by clock
Set the time to stop operation. The time can be set in the unit of 5-minute. This setting can be activated only once or at every time.
Note (1) It is necessary to set the clock to use this timer.
- (vi) Weekly timer
Set the ON or OFF timer for a week. Up to 8 patterns can be set for a day. The day-off setting is provided for holidays and non-business days.
Note (1) It is necessary to set the clock to use the weekly timer.

(vii) Combination of patterns which can be set for the timer operations

	Sleep time	Set OFF timer by hour	Set ON timer by hour	Set OFF timer by clock	Set ON timer by clock	Weekly timer
Sleep time		×	×	○	○	○
Set OFF timer by hour	×		×	×	×	×
Set ON timer by hour	×	×		×	×	×
Set OFF timer by clock	○	×	×		○	×
Set ON timer by clock	○	×	×	○		×
Weekly timer	○	×	×	×	×	

Note (1) ○: Allowed ×: Not

(b) RC-E5

- (i) Sleep timer
Set the duration of time from the present to the time to turn off the air-conditioner.
It can be selected from 10 steps in the range from “OFF 1 hour later” to “OFF 10 hours later”. After the sleep timer setting, the remaining time is displayed with progress of time in the unit of hour.
- (ii) OFF timer
Time to turn OFF the air-conditioner can be set in the unit of 10 minutes.
- (iii) ON timer
Time to turn ON the air-conditioner can be set. Indoor temperature can be set simultaneously.
- (iv) Weekly timer
Timer operation (ON timer, OFF timer) can be set up to 4 times a day for each weekday.

(v) Timer operations which can be set in combination

Item \ Item	Timer	OFF timer	ON timer	Weekly timer
Timer		×	○	×
OFF timer	×		○	×
ON timer	○	○		×
Weekly timer	×	×	×	

Notes (1) ○: Allowed ×: Not

(2) Since the ON timer, sleep timer and OFF timer are set in parallel, when the times to turn ON and OFF the air-conditioner are duplicated, the setting of the OFF timer has priority.

(5) Hot start (Cold draft prevention at heating)**(a) Operating conditions**

When either one of following conditions is satisfied, the hot start control is performed.

- (i) From stop to heating operation
- (ii) From cooling to heating operation
- (iii) Form heating thermostat OFF to ON
- (iv) After completing the defrost operation (only on units with thermostat ON)

(b) Contents of operation

(i) Indoor fan motor control at hot start

- 1) Within 7 minutes after starting heating operation, the fan mode is determined depending on the condition of thermostat (fan control with heating thermostat OFF).

a) Thermostat OFF

- i) Operates according to the fan control setting at heating thermostat OFF.
- ii) Even if it changes from thermostat OFF to ON, the fan continues to operate with the fan control at thermostat OFF till the heat exchanger temperature sensor (Thi-R1 or R2, whichever higher) detects 35°C or higher.
- iii) When the heat exchanger temperature sensor (Thi-R1 or R2, whichever higher) detects 35°C or higher, the fan operates with the set air flow volume.

b) Thermostat ON

- i) When the heat exchanger temperature sensor (Thi-R1 or R2, whichever higher) detects 25°C or lower, the fan is turned OFF and does not operate.
 - ii) When the heat exchanger temperature sensor (Thi-R1 or R2, whichever higher) detects 25°C or higher, the fan operates with the fan control at heating thermostat OFF.
 - iii) When the heat exchanger temperature sensor (Thi-R1 or R2, whichever higher) detects 35°C or higher, the fan operates with the set air flow volume.
- c) If the fan control at heating thermostat OFF is set at the “Set air flow volume” (from the remote control), the fan operates with the set air flow volume regardless of the thermostat ON/OFF.

- 2) Once the fan motor is changed from OFF to ON during the thermostat ON, the indoor fan motor is not turned OFF even if the heat exchanger temperature sensor detects lower than 25°C.

Note (1) When the defrost control signal is received, it complies with the fan control during defrost operation.

- 3) Once the hot start is completed, it will not restart even if the temperature on the heat exchanger temperature sensor drops.

(ii) During the hot start, the louver is kept at the horizontal position.

(iii) When the fan motor is turned OFF for 7 minutes continuously after defrost operation, the fan motor is turned ON regardless of the temperatures detected with the indoor heat exchanger temperature sensors (Thi-R1, R2).

(c) Ending condition

(i) If one of following conditions is satisfied during the hot start control, this control is terminated, and the fan is operated with the set air flow volume.

- 1) Heat exchanger temperature sensor (Thi-R1 or R2, whichever higher) detects 35°C or higher.
- 2) It has elapsed 7 minutes after starting the hot start control.

(6) Hot keep

Hot keep control is performed at the start of the defrost operation.

(a) Control

- (i) When the indoor heat exchanger temperature (detected with Thi-R1 or R2) drops to less than 35°C, the speed of indoor fan follows fan setting at the time of thermostat OFF.
- (ii) During the hot keep, the louver is kept at the horizontal position.

(7) Auto swing control (FDT, FDTC, FDE only)

Note Even if [Auto Swing] is selected, the louver position with anti draft function is fixed to position 1.

(a) RC-EX3A**(i) Louver control**

- 1) To operate the swing louver when the air-conditioner is operating, press the “Direction” button on the TOP screen of remote control. The wind direction select screen will be displayed.
- 2) To swing the louver, touch the “Auto swing” button. The lover will move up and down. To fix the swing louver at a position, touch one of [1] - [4] buttons. The swing louver will stop at the selected position.
- 3) Louver operation at the power on with a unit having the louver 4-position control function
The louver swings one time automatically (without operating the remote control) at the power on.
This allows the microcomputer recognizing and inputting the louver motor (LM) position.

(ii) Automatic louver level setting during heating

At the hot start and the heating thermostat OFF, regardless whether the auto swing switch is operated or not (auto swing or louver stop), the louver takes the level position (in order to prevent blowing of cool wind). The louver position display LCD continues to show the display which has been shown before entering this control.

(iii) Louver free stop control

If you touch the “Menu” → “Next” → “R/C settings” buttons one after another on the TOP screen of remote control, the “Flap control” screen is displayed. If the free stop is selected on this screen, the louver motor stops upon receipt of the stop signal from the remote control. If the auto swing signal is received from the remote control, the auto swing will start from the position before the stop.

(b) RC-E5**(i) Louver control**

- 1) Press the “LOUVER” button to operate the swing louver when the air-conditioner is operating.
“SWING 

Note (1) If you press the “LOUVER” button, the swing motion is displayed on the louver position LCD for 10 seconds. The display changes to the “SWING **(ii) Automatic louver level setting during heating**

At the hot start with the heating thermostat OFF, regardless whether the auto swing switch is operated or not (auto swing or louver stop), the louver takes the level position (In order to prevent the cold start). The louver position display LCD continues to show the display which has been shown before entering this control.

(iii) Louver-free stop control

When the louver-free stop has been selected with the indoor function of wired remote control “

Note (1) When the indoor function of wired remote control “- 16 -

(8) Thermostat operation**(a) Cooling**

- (i) Thermostat is operated with the room temperature control.
- (ii) Thermostat is turned ON or OFF relative to the set room temperature as shown below.

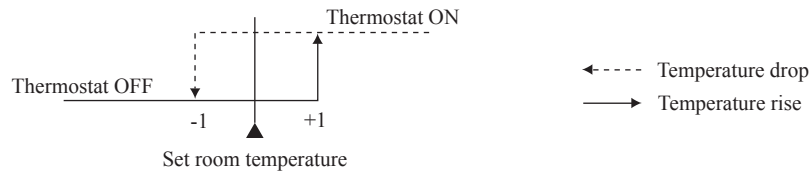

- (iii) Thermostat is turned ON when the room temperature is in the range of $-1 < \text{Set temperature} < +1$ at the start of cooling operation (including from heating to cooling).

(b) Heating

- (i) Thermostat is operated with the room temperature control.
- (ii) Thermostat is turned ON or OFF relative to the set room temperature as shown below.

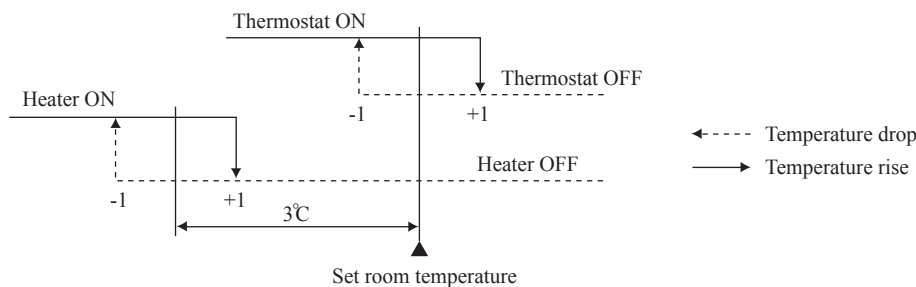

- (iii) Thermostat is turned ON when the room temperature is in the range of $-1 < \text{Set point} < +1$ at the start of heating operation (Including from cooling to heating).

(c) Fan control during heating thermostat OFF

- (i) Following fan controls during the heating thermostat OFF can be selected with the indoor function setting of the wired remote control.
 - ① Low fan speed (Factory default), ② Set fan speed, ③ Intermittence, ④ Fan OFF
- (ii) When the “Low fan speed (Factory default)” is selected, the following taps are used for the indoor fans.
 - For DC motor : ULo tap
- (iii) When the “Set fan speed” is selected, it is operated with the set fan speed also in the thermostat OFF condition.
- (iv) If the “Intermittence” is selected, following controls are performed:
 - 1) If the thermostat is turned OFF during the heating operation, the indoor unit moves to the hot control and turns OFF the indoor fan if the heat exchanger temperature sensors (both Thi-R1 and R2) detect 25°C or lower.
 - 2) Indoor fan OFF is fixed for 5 minutes. After the 5 minutes, the indoor fan is operated at ULo for 2 minutes. In the meantime the louver is controlled at level.
 - 3) After operating at ULo for 2 minutes, the indoor fan moves to the state of 1) above.
 - 4) If the thermostat is turned ON, it moves to the hot start control.
 - 5) When the heating thermostat is turned OFF, the remote control displays the temperature detected at the fan stop and revises the temperature later when the indoor fan changes from ULo to stop. The remote control uses the operation data display function to display temperatures and updates values of temperature even when the indoor fan is turned OFF.
 - 6) When the defrost operation starts while the heating thermostat is turned OFF or the thermostat is turned OFF during defrost operation, the indoor fan is turned OFF. (Hot keep or hot start control takes priority.) However, the suction temperature is updated at every 7-minute.
 - 7) When the heating thermostat is turned ON or the operation is changed to another mode (including stop), this control is stopped immediately, and the operating condition is restored.
- (v) When the “Fan OFF” is selected, the fan on the indoor unit of which the thermostat has been turned OFF, is turned OFF. The same occurs also when the remote control sensor is effective.

(d) Fan control during cooling thermostat OFF

- (i) Following fan controls during the cooling thermostat OFF can be selected with the indoor function setting of the wired remote control.
 - ① Low fan speed, ② Set fan speed (Factory default), ③ Intermittence, ④ Fan OFF
- (ii) When the “Low fan speed” is selected, the following taps are used for the indoor fans.
 - For DC motor : ULo tap
- (iii) When the “Set fan speed” is selected, it is operated with the set fan speed also in the thermostat OFF condition.
- (iv) If the “Intermittence” is selected, following controls are performed:
 - 1) If the thermostat is turned OFF during the cooling operation, the indoor fan motor stops.
 - 2) Indoor fan OFF is fixed for 5 minutes. After the 5 minutes, the indoor fan is operated at ULo for 2 minutes. In the meantime the louver is controlled at level.
 - 3) After operating at ULo for 2 minutes, the indoor fan moves to the state of 1) above.
 - 4) If the thermostat is turned ON, the fan starts operation at set fan speed.
 - 5) When the cooling thermostat is turned OFF, the remote control displays the temperature detected at the fan stop and revises the temperature later when the indoor fan changes from ULo to stop.
By using operation data display function at wireless remote control, the temperature as displayad and the value is updated including the fan stops.
 - 6) When the cooling thermostat is turned ON or the operation is changed to another mode (Including stop), this control is stopped immediately, and the operating condition is restored.
- (v) When the “Fan OFF” is selected, the fan on the indoor unit of which the thermostat has been turned OFF, is turned OFF. The same occurs also when the remote control sensor is effective.

(9) Filter sign

As the operation time (Total ON time of ON/OFF switch) accumulates to 180 hours (1), “FILTER CLEANING” is displayed on the remote control. (This is displayed when the unit is in trouble and under the central control, regardless of ON/OFF.)

Notes (1) Time setting for the filter sign can be made as shown below using the indoor function of wired remote control “Filter sign”. (It is set at setting 1 at the shipping from factory.)

Filter sign setting	Function
Setting 1	Setting time: 180 hrs (Factory default)
Setting 2	Setting time: 600 hrs
Setting 3	Setting time: 1,000 hrs
Setting 4	Setting time: 1,000 hrs (Unit stop) ⁽²⁾

(2) After the setting time has elapsed, the “FILTER CLEANING” is displayed and, after operating for 24 hours further (counted also during the stop), the unit stops.

(10) Compressor inching prevention control

(a) 3-minute timer

When the compressor has been stopped by the thermostat, remote control operation switch or anomalous condition, its restart will be inhibited for 3 minutes. However, the 3-minute timer is invalidated at the power on the electric power source for the unit.

(b) 3-minute forced operation timer

- (i) Compressor will not stop for 3 minutes after the compressor ON. However, it stops immediately when the unit is stopped by means of the ON/OFF switch or when the thermostat turned OFF by the change of operation mode.
- (ii) If the thermostat is turned OFF during the forced operation control of heating compressor, the louver position (with the auto swing) is returned to the level position.

Note (1) The compressor stops when it has entered the protective control.

(11) Drain pump control

- (a) This control is operated when the inverter frequency is other than 0 Hz during the cooling operation and automatic cooling and dehumidifying operations.
- (b) Drain pump ON condition continues for 5 minutes even when it enters the OFF range according to (i) above after turning the drain pump ON, and then stops. The 5-minute delay continues also in the event of anomalous stop.
- (c) The drain pump is operated with the 5-minute delay operation when the compressor is changed from ON to OFF.
- (d) Even in conditions other than the above (such as heating, fan, stop, cooling thermostat OFF), the drain pump control is performed by the drain detection.
- (e) Following settings can be made using the indoor function setting of the wired remote control.
 - (i) 标准 [Standard (in cooling & dry)] : Drain pump is run during cooling and dry.
 - (ii) 标准AND采暖 [Operate in standard & heating] : Drain pump is run during cooling, dry and heating.
 - (iii) 标准AND采暖AND送风 [Operate in heating & fan] : Drain pump is run during cooling, dry, heating and fan.
 - (iv) 标准AND送风 [Operate in standard & fan] : Drain pump is run during cooling, dry and fan.

Note (1) Values in [] are for the RC-EX3A model.

(12) Drain pump motor (DM) control

- (a) Drain detection switch is turned ON or OFF with the float switch (FS) and the timer.

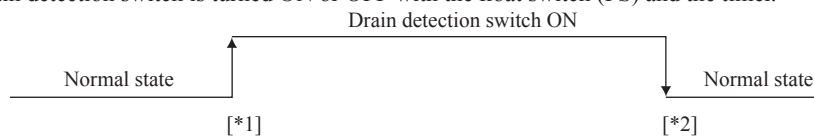

[*1] Drain detection switch is turned “ON” when the float switch “Open” is detected for 3 seconds continuously in the drain detectable space.

[*2] Drain detection switch is turned “OFF” when the float switch “Close” is detected for 10 seconds continuously.

- (i) It detects always from 30 seconds after turning the power ON.
 - 1) There is no detection of anomalous draining for 10 seconds after turning the drain pump OFF.
 - 2) Turning the drain detection switch “ON” causes to turn ON the drain pump forcibly.
 - 3) Turning the drain detection switch “OFF” releases the forced drain pump ON condition.
- (b) Indoor unit performs the control A or B depending on each operating condition.

	Indoor unit operation mode				
	Stop ⁽¹⁾	Cooling	Dry	Fan ⁽²⁾	Heating
Compressor ON		Control A			
Compressor OFF		Control B			

Notes (1) Including the stop from the cooling, dehumidifying, fan and heating, and the anomalous stop
 (2) Including the “Fan” operation according to the mismatch of operation modes

- (i) Control A
 - 1) If the float switch detects any anomalous draining condition, the unit stops with the anomalous stop (displays E9) and the drain pump starts. After detecting the anomalous condition, the drain pump motor continues to be ON.
 - 2) It keeps operating while the float switch is detecting the anomalous condition.
- (ii) Control B

If the float switch detects any anomalous drain condition, the drain pump motor is turned ON for 5 minutes, and at 10 seconds after the drain pump motor OFF it checks the float switch. If it is normal, the unit is stopped under the normal mode or, if there is any anomalous condition, E9 is displayed and the drain pump motor is turned ON. (The ON condition is maintained during the drain detection.)

(13) Operation check/drain pump test run operation mode

- (a) If the power is turned on by the DIP switch (SW7-1) on the indoor unit control PCB when electric power source is supplied, it enters the mode of operation check/drain pump test run. It is ineffective (prohibited) to change the switch after turning power on.
- (b) When the communication with the remote control has been established within 60 seconds after turning power on by the DIP switch (SW7-1) ON, it enters the operation check mode. Unless the remote control communication is established, it enters the drain pump test run mode.

Note (1) To select the drain pump test run mode, disconnect the remote control connector (CNB) on the indoor unit PCB to shut down the remote control communication.

(c) Operation check mode

There is no communication with the outdoor unit but it allows performing operation in respective modes by operating the remote control.

(d) Drain pump test run mode

As the drain pump test run is established, the drain pump only operates and during the operation protective functions by the microcomputer of indoor unit become ineffective.

(14) Cooling, dehumidifying frost protection

- (a) To prevent frosting during cooling mode or dehumidifying mode operation, the thermostat-OFF if the indoor heat exchanger temperature (detected with Thi-R) drops to 1.0 °C or lower at 4 minutes after the thermostat-ON. If the indoor unit heat exchanger temperature is 1.0 °C or lower after 5 minutes, the indoor unit is controlled thermostat-OFF. If it becomes 10°C or higher, the control terminates. When the indoor heat exchanger temperature has become as show, the indoor unit send outdoor unit the “Anti-frost” signal.

- Frost prevention temperature setting can be selected with the indoor unit function setting of the wired remote control.

Item	Symbol	A
Temperature - Low (Factory default)		1.0
Temperature - High		2.5

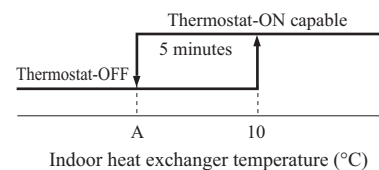

(b) Selection of indoor fan speed

If it enters the frost prevention control during cooling operation (excluding dehumidifying), the indoor fan speed is switched.

- (i) When the indoor return air detection temperature (detected with Thi-A) is C°C or higher and the indoor heat exchanger temperature (detected with Thi-R) detects the compressor frequency drop start temperature A°C+1°C, indoor fan speed is increased by 20min⁻¹.
- (ii) If the phenomenon of (i) above is detected again after the acceleration of indoor fan, indoor fan speed is increased further by 20min⁻¹.

Note (1) Indoor fan speed can be increased by up to 2 taps.

- Compressor frequency drop start temperature (FDT&FDTC only)

Hs > 50%

Symbol	Item	Low	High
A		1.0	2.5
B		2.5	4.0

Hs ≤ 50%

Symbol	Item	Low	High
A		-0.5	1.0
B		1.0	2.5

- Indoor fan speed control start temperature

Symbol	Indoor	FDT-VH	Other
C		18	23

Note (1) Frost prevention temperature setting can be selected with the indoor unit function setting of the wired remote control.

(15) Heating overload protection

- (a) If the indoor heat exchanger temperature (detected with Thi-R) at 63°C or higher is detected for 2 seconds continuously, the compressor stops. When the compressor is restarted after a 3-minute delay, if a temperature at 63°C or higher is detected for 2 seconds continuously within 60 minutes after initial detection and if this is detected 5 times consecutively, the compressor stops with the anomalous stop (E8). Anomalous stop occurs also when the indoor heat exchanger temperature at 63°C or higher is detected for 6 minutes continuously.

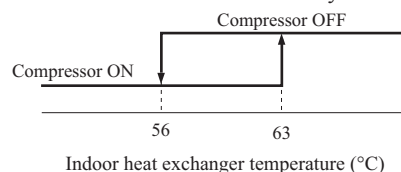

(b) Indoor fan speed selection

If, after second detection of heating overload protection up to fourth, the indoor fan is set at below Hi tap when the compressor is turned ON, the indoor fan speed is increased by 1 tap.

(16) Anomalous fan motor

- (a) After starting the fan motor, if the fan motor speed is 200 min⁻¹ or less is detected for 30 seconds continuously and 4 times within 60 minutes, then fan motor stops with the anomalous stop (E16).
- (b) If the fan motor fails to reach at -50 min⁻¹(FDU:-500 min⁻¹) less than the required speed, it stops with the anomalous stop (E20).

(17) Plural unit control – Control of 16 units group by one remote control

(a) Function

One remote control can control a group of multiple number of unit (Max. 16 indoor units). “Operation mode” which is set by the remote control can operate or stop all units in the group one after another in the order of unit No.⁽¹⁾. Thermostat and protective function of each unit function independently.

Note (1) Unit No. is set by SW2 on the indoor unit control PCB. Unit No. setting by SW2 is necessary for the indoor unit only. In cases of the twin, triple and double twin specification, it is necessary set for the master and the slave units. This can be selected by SW5. (All are set for the master unit at the shipping from factory.)

SW2: For setting of 0 – 9, A – F
 SW5: For setting of master and slave units
 (See table shown at right.)

Unit	SW5 setting	
	SW5-1	SW5-2
Master unit	OFF	OFF
Slave unit a	OFF	ON
Slave unit b	ON	OFF
Slave unit c	ON	ON

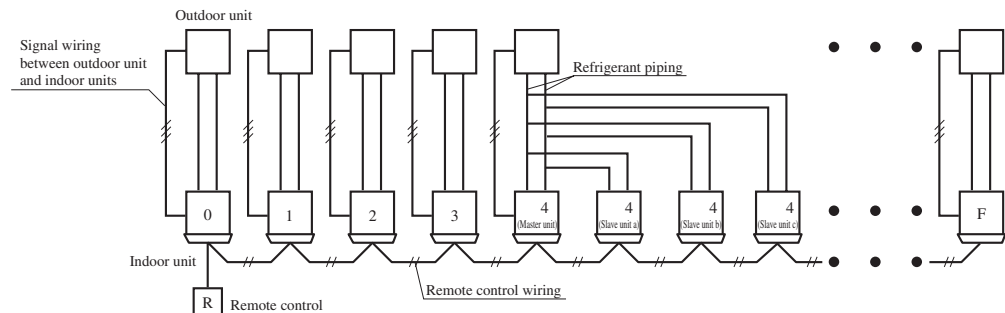

(2) Unit No. may be set at random unless duplicated, it should be better to set orderly like 0, 1, 2..., F to avoid mistake.

(b) Display to the remote control

- (i) Central or each remote control basis, heating preparation
 The smallest unit No. among the operating units in the remote mode (or the center mode unless the remote mode is available) is displayed.
- (ii) Inspection display, filter sign
 Any of unit that starts initially is displayed.

(c) Confirmation of connected units

- (i) In case of RC-EX3A remote control
 If you touch the buttons in the order of “Menu” → “Service setting” → “Service & Maintenance” → “Service password” → “IU address” on the TOP screen of remote control, the indoor units which are connected are displayed.
- (ii) In case of RC-E5 remote control
 Pressing “AIR CON No.” button on the remote control displays the indoor unit address. If “▲” “▼” button is pressed at the next, it is displayed orderly starting from the unit of smallest No.

(d) In case of anomaly

If any anomaly occurs on a unit in a group (a protective function operates), that unit stops with the anomalous stop but any other normal units continue to run as they are.

(e) Signal wiring procedure

Signal wiring between indoor and outdoor units should be made on each unit same as the normal wiring. For the group control, connect the remote control wiring to each indoor unit via terminal block for the remote control. Connect the remote control wiring separately from the power source cable or wires of other electric devices (AC220V or higher).

(18) High ceiling control

When sufficient air flow rate cannot be obtained from the indoor unit which is installed at a room with high ceiling, the air flow rate can be increased by changing the fan tap. To change the fan tap, use the indoor unit function “FAN SPEED SET” on the wired remote control.

Fan tap	Indoor unit air flow setting				Series	
	●●●●	●●●●	●●●●	●●●●		
FAN SPEED SET	STANDARD	P-Hi1 - Hi - Me - Lo	Hi - Me - Lo	Hi - Lo	Hi - Me	Except FDT, FDE
		P-Hi2 - Hi - Me - UL0	Hi - Me - Lo	Hi - Lo	Hi - Me	Only FDT
		P-Hi2 - Hi - Me - Lo	Hi - Me - Lo	Hi - Lo	Hi - Me	Only FDE
	HIGH SPEED1	P-Hi1 - P-Hi1 - Hi - Me	P-Hi1 - Hi - Me	P-Hi1 - Me	P-Hi1 - Hi	Except FDT, FDE
		P-Hi2 - P-Hi1 - Hi - Me	P-Hi1 - Hi - Me	P-Hi1 - Me	P-Hi1 - Hi	Only FDT
		P-Hi1 - Hi - Me - Lo	Hi - Me - Lo	Hi - Lo	Hi - Me	Only FDE
HIGH SPEED2	P-Hi2 - Hi - Me - Lo	Hi - Me - Lo	Hi - Lo	Hi - Me	Only FDT, FDE	

Notes (1) Factory default is STANDARD.
 (2) At the hot-start and heating thermostat OFF, or other, the indoor fan is operated at the low speed tap of each setting.
 (3) This function is not able to be set with wireless remote control or simple remote control (RCH-E3).

(19) Abnormal temperature sensor (return air/indoor heat exchanger) broken wire/short-circuit detection

(a) Broken wire detection

When the return air temperature sensor detects -55°C or lower or the heat exchanger temperature sensor detect -55°C or lower for 5 seconds continuously, the compressor stops. After a 3-minute delay, the compressor restarts but, if it is detected again within 60 minutes after the initial detection for 6 minutes continuously, stops again (the return air temperature sensor: E7, the heat exchanger temperature sensor: E6).

(b) Short-circuit detection

If the heat exchanger temperature sensor detects short-circuit for 5 seconds continuously at 2 minutes and 20 seconds after the compressor ON during cooling operation, the compressor stops (E6).

(20) External input/output control (CnT or CnTA)

External input/output connectors are provided on the indoor unit control PCB, and each input/output is possible to be changed by RC-EX3A.

Be sure to connect the wired remote control to the indoor unit. Remote operation with CnT/CnTA only is not possible.

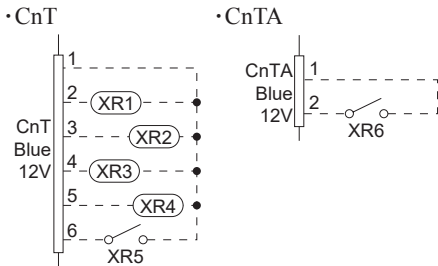

Input/Output	Connector	Factory default setting	RC-EX3A function name
Output	CnT-2 (XR1)	Operation output	External output 1
	CnT-3 (XR2)	Heating output	External output 2
	CnT-4 (XR3)	Compressor ON output	External output 3
	CnT-5 (XR4)	Inspection(Error) output	External output 4
"Input (Volt-free contact)"	CnT-6 (XR5)	Remote operation input	External input 1
	CnTA (XR6)	Remote operation input	External input 2

■ Priority order for combinations of CnT and CnTA input.

		CnTA					
		① Operation stop level	② Operation stop pulse	③ Operation permission/prohibition	④ Operation permission/prohibition pulse	⑤ Cooling/heating selection level	⑥ Cooling/heating selection pulse
CnT	① Operation stop level	CnT ①	CnT ①	CnT ① + CnTA ②	CnT ①	CnT ① / CnTA ⑤	CnT ① / CnTA ⑥
	② Operation stop pulse	CnT ②	CnT ②	CnT ② + CnTA ③	CnT ②	CnT ② / CnTA ⑤	CnT ② / CnTA ⑥
	③ Operation permission/prohibition level	CnT ③ > CnTA ①	CnT ③ > CnTA ②	CnT ③ + CnTA ③	CnT ③	CnT ③ / CnTA ⑤	CnT ③ / CnTA ⑥
	④ Operation permission/prohibition pulse	CnT ④	CnT ④	CnT ④ + CnTA ③※	CnT ④	CnT ④ / CnTA ⑤	CnT ④ / CnTA ⑥
	⑤ Cooling/heating selection level	CnT ⑤ / CnTA ①	CnT ⑤ / CnTA ②	CnT ⑤ / CnTA ③	CnT ⑤ / CnTA ④	CnT ⑤	CnT ⑤
	⑥ Cooling/heating selection pulse	CnT ⑥ / CnTA ①	CnT ⑥ / CnTA ②	CnT ⑥ / CnTA ③	CnT ⑥ / CnTA ④	CnT ⑥	CnT ⑥

Note (1) Following operation commands are accepted when the operation prohibition is set with CnTA as indicated with *.

Individual operation command from remote control, test run command from outdoor unit and operation command from option device, CnT input.

Reference: Explanation on the codes and the combinations of codes in the table above

- In case of CnT "Number", the CnT "Number" is adopted and CnTA is invalidated.
 - In case of CnTA "Number", the CnTA "Number" is adopted and CnT is invalidated.
 - In case of CnT "Number"/CnTA "Number", the CnT "Number" and the CnTA "Number" become independent functions each other.
 - In case of CnT "Number" + CnTA "Number", the CnT "Number" and the CnTA "Number" become competing functions each other.
 - In case of CnT "Number" > CnTA "Number", the function of CnT "Number" supersedes that of CnTA "Number".
 - In case of CnT "Number" < CnTA "Number", the function of CnTA "Number" supersedes that of CnT "Number".
- (The "Number" above means ① - ⑥ in the table.)

(a) Output for external control (remote display)

Indoor unit outputs the following signal for operation status monitoring.

	Output name	Condition
1	Operation output	During operation
2	Heating output	During heating operation
3	Compressor ON output	During compressor operation
4	Inspection(Error) output	When anomalous condition occurs.
5	Cooling output	During cooling operation
6	Fan operation output 1	When indoor fan is operating
7	Fan operation output 2	When indoor fan is operating, and fan speed is higher than Hi speed.
8	Fan operation output 3	When indoor fan is operating, and fan speed is Lower than Me speed.
9	Defrost/oil return output	When indoor unit receive defrost/oil return signal from the outdoor unit.
10	Ventilation output	When "Venti.ON" is selected from remote control
11	Free cooling output	When the ambient temperature is between 10 - 18°C in cooling and fan operation
12	Indoor unit overload alarm output	Refer to "IU overload alarm"
13	Heater output	Refer to "(8) Thermostat operation (b) Heating"

(b) Input for external control

The external input for the indoor unit can be selected from the following input.

	Input name	Content
1	Run/Stop	Refer to [(20) (c) Remote operation input]
2	Permission/Prohibition	Refer to [(21) Operation permission/prohibition]
3	Cooling/Heating	Refer to [(23) Selection of cooling/heating external input function]
4	Emergency stop	Indoor/outdoor units stop the operation, and [E63] is displayed.
5	Setting temperature shift	Set temperature is shifted by +2/-2°C in cooling/heating.
6	Forced thermo-OFF	Unit goes thermo off.
7	Temporary stop	Refer to [(22) Temporary stop input]
8	Silent mode	Outdoor unit silent mode is activated.

(i) In case of “Level input” setting (Factory default)

Input signal to CnT-6 or CnTA is OFF→ON unit ON

Input signal to CnT-6 or CnTA is ON→OFF unit OFF

Operation is not inverted.

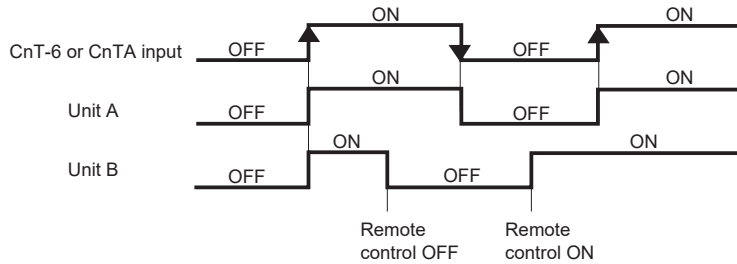

Note (1) The latest operation has priority

It is available to operate/stop by remote control or central control

(ii) In case of “Pulse input” setting (Local setting)

It is effective only when the input signal to CnT-6 or CnTA is changed OFF→ON, and at that time unit operation [ON/OFF] is inverted.

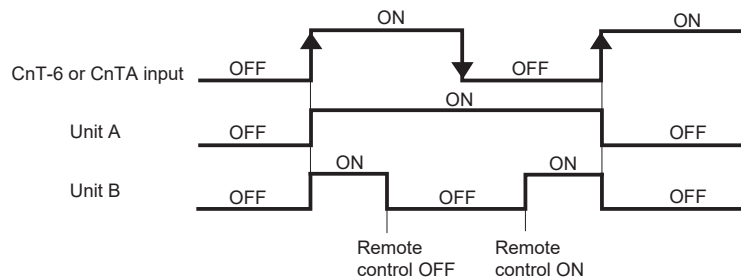

(c) Remote operation

(i) In case of multiple units (Max. 16 indoor units group) are connected to one wired remote control

When the R/C function setting of wired remote control for “External control set” is changed from “Individual (Factory default)” to “For all units”, all units connected in one wired remote control system can be controlled by external operation input.

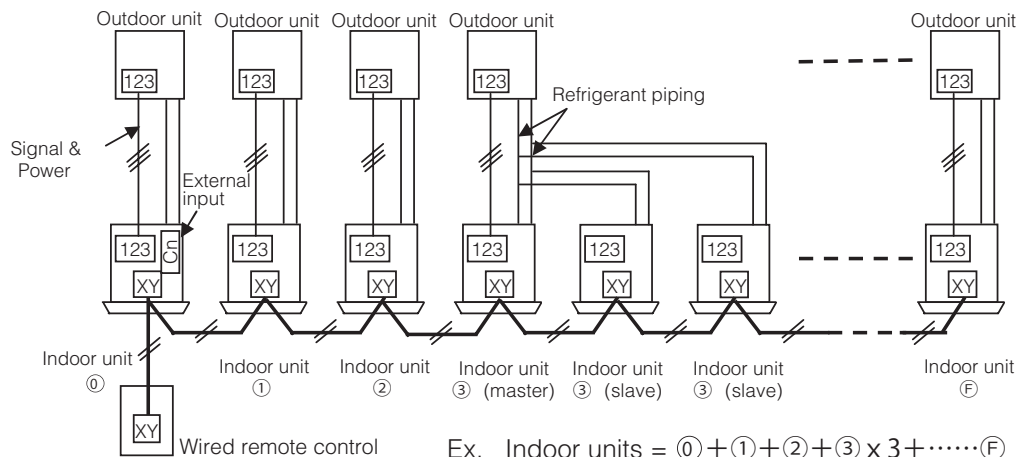

Ex. Indoor units = ① + ② + ③ × 3 + ⑥ ≤ 16 units

CnT-6 or CnTA	Individual operation (Factory default)		All units operation (Local setting)	
	ON	OFF	ON	OFF
	Only the unit directly connected to the remote control can be operated.	Only the unit directly connected to the remote control can be stopped operation.	All units in one remote control system can be operated.	All units in one remote control system can be stopped operation.
	Unit ① only	Unit ① only	Units ① – ⑥	Units ① – ⑥

When more than one indoor unit (Max. 16 indoor units) are connected in one wired remote control system:

- (1) With the factory default, external input to CnT-6 or CnTA is effective for only the unit ①.
- (2) When setting “For all unit” (Local setting), all units in one remote control system can be controlled by external input to CnT-6 or CnTA on the indoor unit ①.
- (3) External input to CnT-6 or CnTA on the other indoor unit than the unit ① is not effective.

(21) Operation permission/prohibition

(In case of adopting card key switches or commercially available timers)

When the indoor function setting of wired remote control for “Operation permission/prohibition” is changed from “Invalid (Factory default)” to “Valid”, following control becomes effective.

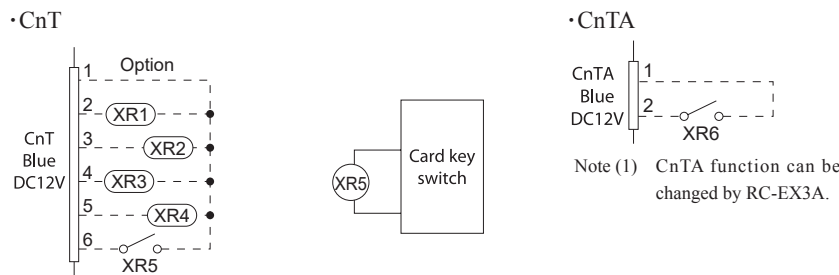

CnT-6 or CnTA	Normal operation (Factory default)		Operation permission/prohibition mode “Valid” (Local setting)	
	ON	OFF	ON	OFF
	Operation	Stop	Operation permission*1	Operation prohibition (Unit stops)

*1 **Only the “LEVEL INPUT” is acceptable for external input**, however when the indoor function setting of “Level input (Factory default)” or “Pulse input” is selected by the function for “External input” of the wired remote control, operation status will be changed as follows.

In case of “Level input” setting	In case of “Pulse input” setting
Unit operation from the wired remote control becomes available ※ 1	Unit starts operation ※ 2

※ 1) In case that “Operation permission/prohibition mode” setting is “Valid” and “External input” setting is “Level input (Factory default)”;

- ① When card key switch is ON (CnT-6 or CnTA ON: Operation permission), start/stop operation of the unit from the wired remote control becomes available.
- ② When card key switch is OFF (CnT-6 or CnTA OFF: Operation prohibition), the unit stops operation in conjunction with OFF signal, and start/stop operation of the unit from the wired remote control becomes unavailable.

※ 2) In case that “Operation permission/prohibition mode” setting is “Valid” and “External input” setting is “Pulse input (Local setting)”;

- ① When card key switch is ON (Operation permission), the unit starts operation in conjunction with ON signal, and also start/stop operation of the unit from the wired remote control becomes available.
- ② When card key switch is OFF (Operation prohibition), the unit stops operation in conjunction with OFF signal, and start/stop operation of the unit from the wired remote control becomes unavailable.

3) This function is invalid only at “Center mode” setting done by central control.

(a) In case of CnT ① Operation stop level > CnTA ③ Operation permission/prohibition level

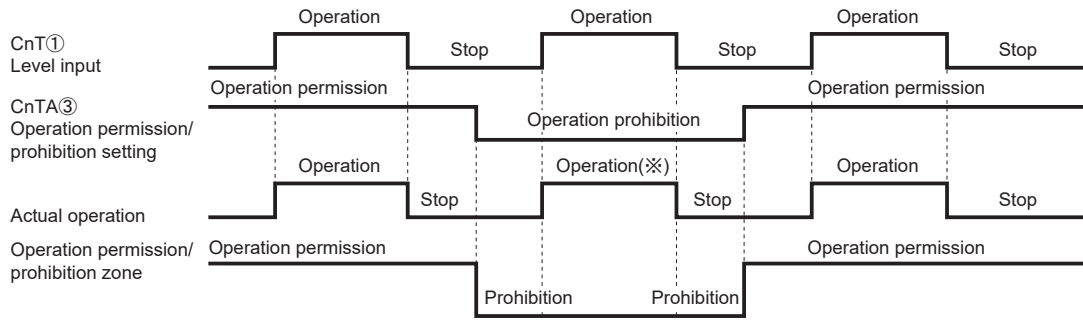

(※) CnT level input supersedes CnTA operation prohibition.

(b) In case of CnT ③ Operation permission/prohibition level + CnTA ③ Operation permission/prohibition level

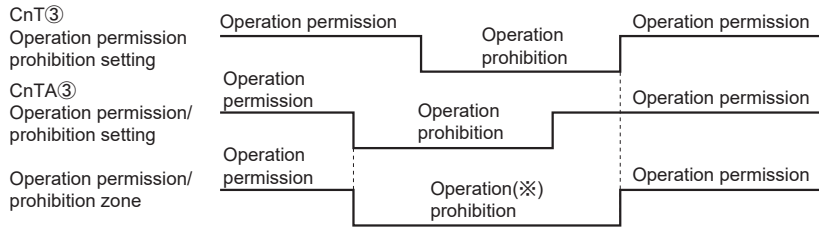

(※) Operation prohibition zone is determined by the OR judgment between CnT operation prohibition zone and CnTA operation prohibition zone.

(c) In case of CnT ③ Operation permission/prohibition level > CnTA ② Operation/stop pulse

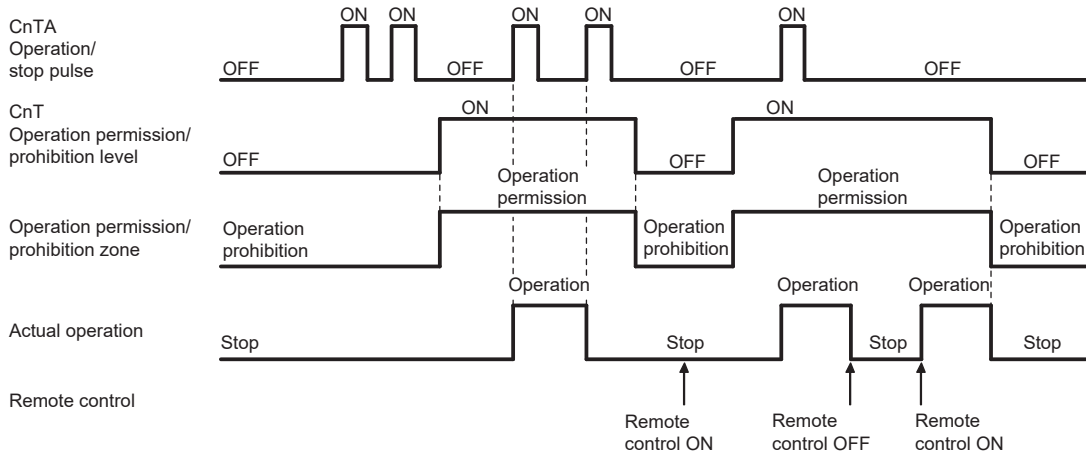

Note (1) If it is prohibited by CnT, all "Operation" and "Stop" commands are not accepted.

(d) In case of CnT ② Operation/stop pulse + CnTA ③ Operation permission/prohibition level

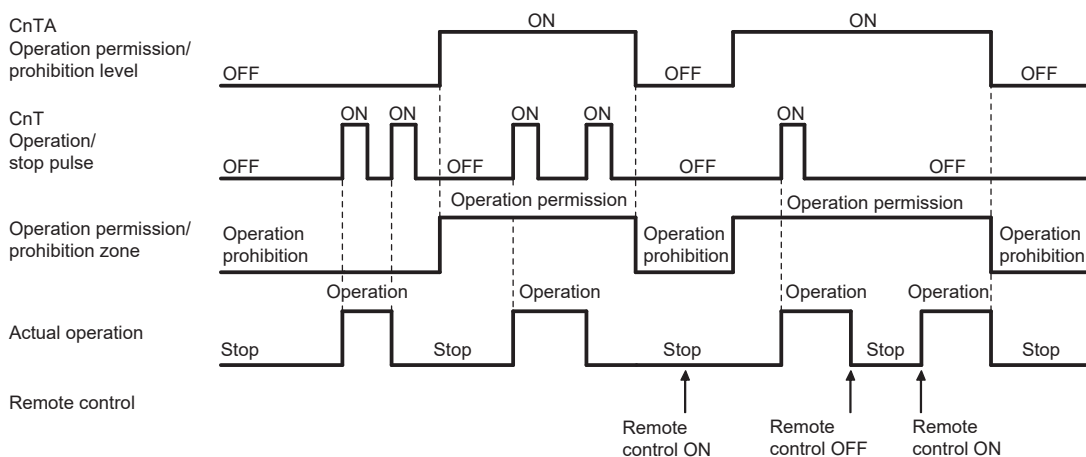

(22) Temporary stop input

In case of temporary stop, operation lamp of remote control lights, but indoor/outdoor unit stop the operation.

(a) In case of "level input" setting (Factory default)

Input signal to CnT-6 or CnTA is OFF → ON : Temporary stop
 Input signal to CnT-6 or CnTA is OFF → ON : Normal operation

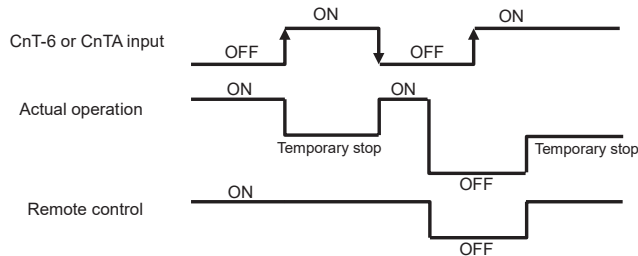

(b) In case of "pulse input" setting (Local setting)

It is effective only when the input signal is changed OFF→ON, and "temporary stop/normal operation" is inverted.

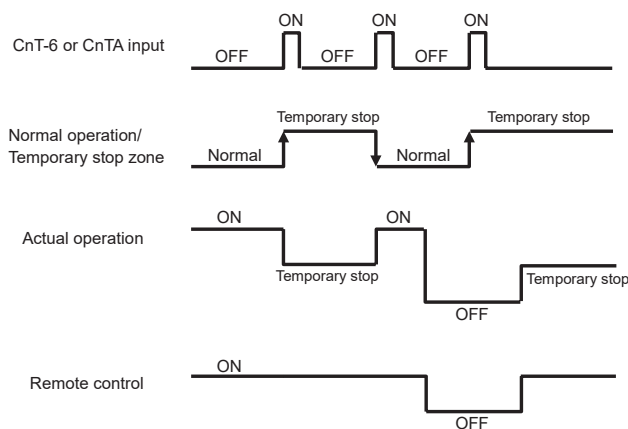

(23) Selection of cooling/heating external input function

- (a) When "External input 1 setting: Cooling/heating" is set by the indoor unit function from remote control, the cooling or heating is selected with CnT-6 or CnTA.
- (b) When the external input 1 method selection: Level input is set by the indoor unit function:
 - CnT-6 or CnTA: OPEN → Cooling operation mode
 - CnT-6 or CnTA: CLOSE → Heating operation mode
- (c) When the external input 1 method selection: Pulse input is set by the indoor unit function:
 - If the external input is changed OPEN → CLOSE, operation modes are inverted (Cooling → Heating or Heating → Cooling).
- (d) If the cooling/heating selection signal is given by the external input, the operation mode is transmitted to the remote control.

■ Selection of cooling/heating external input function

External input selection	External input method	Operation	
External input selection Cooling/heating selection	⑤ Level	External terminal input (CnT or CnTA)	
		Cooling/heating	
	Cooling/heating (Competitive)		
	⑥ Pulse	External terminal input (CnT or CnTA)	
Cooling/heating			
Cooling/heating (Competitive)			

Note (1) Regarding the priority order for combinations of CnT and CnTA, refer to Page 22.

(24) Fan control at heating startup

(a) Starting conditions

At the start of heating operation, if the difference of setting temperature and return air temperature is 5°C or higher after the end of hot start control, this control is performed.

(b) Contents of control

- (i) Sampling is made at each minute and, when the indoor heat exchanger temperature (detected with Thi-R) is 37°C or higher, present number of revolutions of indoor fan speed is increased by 10min⁻¹.
- (ii) If the indoor heat exchanger temperature drops below 37°C at next sampling, present number of revolutions of indoor fan speed is reduced by 10min⁻¹.

(c) Ending conditions

Indoor fan speed is reduced to the setting air flow volume when the compressor OFF is established and at 30 minutes after the start of heating operation.

(25) Room air temperature detection temperature compensation during heating

With the standard specification, the compressor is turned ON/OFF with the thermostat setting temperature. When the thermostat is likely to turn OFF earlier because the unit is installed at the ceiling where warm air tends to accumulate, the setting can be changed with the wired remote control indoor unit function “SP OFFSET”. The compressor and the heater are turned ON/OFF at one of the setting temperature +3, +2 or +1°C in order to improve the feeling of heating. The setting temperature, however, has the upper limit of 30°C.

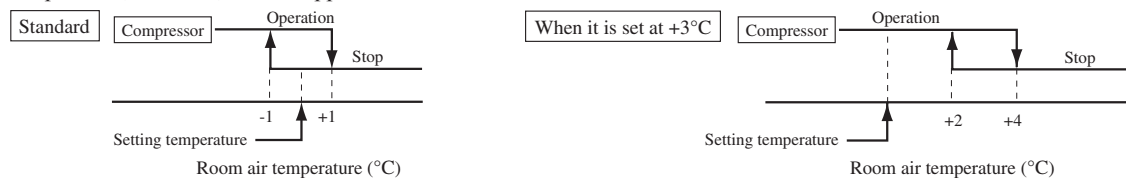

(26) Return air temperature compensation

This is the function to compensate the deviation between the detection temperature by the return air temperature sensor and the measured temperature after installing the unit.

- (a) It is adjustable in the unit of 0.5°C with the wired remote control indoor unit function “RETURN AIR TEMP”.
 - +1.0°C, +1.5°C, +2.0°C
 - -1.0°C, -1.5°C, -2.0°C
- (b) Compensated temperature is transmitted to the remote control and the compressor to control them.

Note (1) The detection temperature compensation is effective on the indoor unit temperature sensor only.

(27) High power operation (RC-EX3A only)

It operates at with the set temperature fixed at 16°C for cooling, 30°C for heating and maximum indoor fan speed for 15 minutes maximum.

(28) Energy-saving operation (RC-EX3A only)

It operates with the setting temperature fixed at 28°C for cooling, 22°C for heating or 25°C for auto. When fan control in cooling/heating thermo-OFF setting is “Set fan speed”, fan speed during thermo-OFF is changed to “Low”. (Maximum capacity is restricted at 80%.)

(29) Warm-up control (RC-EX3A only)

Operation will be started 5 to 60 minutes before use according to the forecast made by the microcomputer which calculates when the operation should be started in order to warm up the indoor air temperature near the setting temperature at the setting time of operation start.

(30) Home leave mode (RC-EX3A only)

When the unit is not used for a long period of time, the room air temperature is maintained at a moderate level, avoiding extremely hot or cool temperature.

- (a) Cooling or heating is operated according to the outdoor air temperature (factory setting 35°C for cooling, 0°C for heating) and the setting temperature. (factory setting 33°C for cooling, 10°C for heating)
- (b) Setting temperature and indoor fan speed can be set by RC-EX3A.

(31) Auto temperature setting (RC-EX3A only)

Setting temperature is adjusted automatically at the adequate temperature the center setting temperature is 24°C by correcting the outdoor air temperature.

(32) Fan circulator operation (RC-EX3A only)

When the fan is used for circulation, the unit is operated as follows depending on the setting with the remote control.

- (a) If the invalid is selected with the remote control, the fan is operated continuously during the fan operation. (normal fan mode)
- (b) If the valid is selected with the remote control, the fan is operated or stopped when on the difference of the remote control temperature sensor and the return air temperature sensor becomes bigger than 3°C.

(33) The operation judgment is executed every 5 minutes (RC-EX3A only)

Setting temperature T_s is changed according to outdoor air temperature.

This control is valid with cooling and heating mode. (Not auto mode)

- (a) Operate 5 minutes forcedly.
- (b) Setting temperature is adjusted every 10 minutes.
 - (i) Cooling mode.
 $T_s = \text{outdoor air temperature} - \text{offset value}$
 - (ii) Heating mode.
 $T_s = \text{outdoor air temperature} - \text{offset value}$
- (c) If the return air temperature lower than 18°C in cooling or return air temperature becomes higher than 25°C in heating, unit goes thermostat OFF.

(34) Auto fan speed control (RC-EX3A only)

In order to reach the room air temperature to the set temperature as quickly as possible, the air flow rate is increased when the set temperature of thermostat differs largely from the return air temperature. According to temperature difference between set temperature and return air temperature, indoor fan tap are controlled automatically.

- Auto 1: Changes the indoor fan tap within the range of Hi ↔ Me ↔ Lo.
- Auto 2: Changes the indoor fan tap within the range of P-Hi ↔ Hi ↔ Me ↔ Lo.

(35) Indoor unit overload alarm (RC-EX3A only)

If the following condition is satisfied at 30 minutes after starting operation, RC-EX3A shows maintenance code "M07" and the signal is transmitted to the external output (CnT-2-5).

- Cooling, Dry, Auto(Cooling) : Indoor air temperature = Set room temperature by remote control + Alarm temperature difference
 - Heating, Auto(Heating) : Indoor air temperature = Set room temperature by remote control - Alarm temperature difference
- Alarm temperature difference is selectable between 5 to 10°C.

If the following condition is satisfied or unit is stopped, the signal is disappeared.

- Cooling, Dry, Auto(Cooling) : Indoor air temperature = Set room temperature + Alarm temperature difference - 2°C
- Heating, Auto(Heating) : Indoor air temperature = Set room temperature - Alarm temperature difference + 2°C

(36) Peak-cut timer (RC-EX3A only)

Power consumption can be reduced by restricting the maximum capacity.

Set the [Start time], the [End time] and the capacity limit % (Peak-cut %).

- 4-operation patterns per day can be set at maximum.
- The setting time can be changed by 5-minutes interval.
- The selectable range of capacity limit % (Peak-cut %) is from 0% to 40-80% (20% interval).
- Holiday setting is available.

(37) Motion sensor control (RC-EX3A and RCN-E2 only)

The sensor determines the presence of people and the amount of activity, and the following controls are done by the motion sensor.

Following settings are necessary to activate motion sensor control.

- (a) Infrared (motion) sensor setting: Installation setting of remote control
The indoor unit which is set to “Enable” become valid.
- (b) Infrared (motion) sensor control: Energy-saving setting of remote control
The function which is set to “Enable” become valid.

RC-EX3A

TOP screen **Menu** ⇒ **Service setting** ⇒ **Installation settings** ⇒ **Service password**

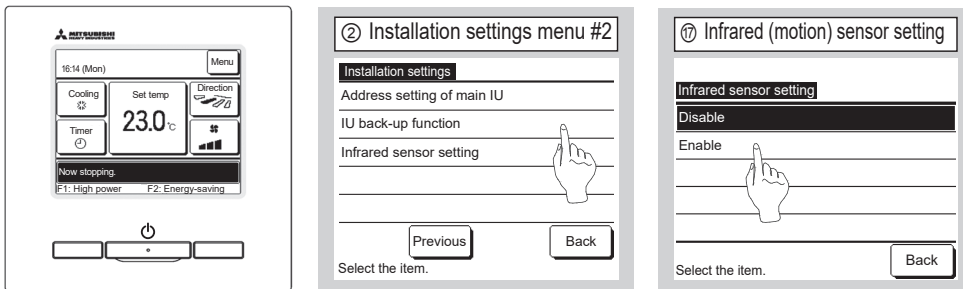

TOP screen **Menu** ⇒ **Energy-saving setting** ⇒ **Infrared sensor control** or **Motion sensor control**

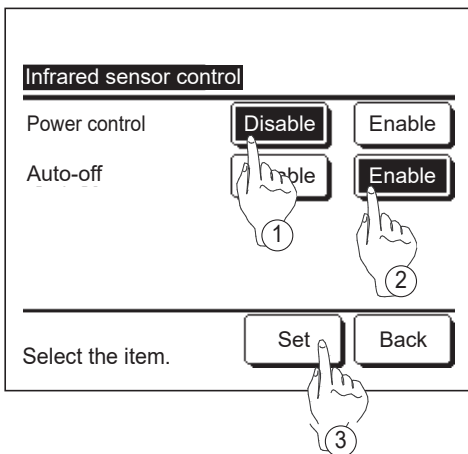

The Infrared sensor control screen and contents of the current settings are displayed.

- ① Enable/disable power control.
- ② Enable/disable auto-off.
- ③ After you set each item, tap the **Set** button.
The display returns to the Energy-saving setting menu screen.

RCN-E2

1. Set indoor functions

- ① Press the ON/OFF button to stop the unit.
- ② Press the desired one of the buttons shown item 2. while holding down the FUNCTION SETTING switch.
- ③ Use the selection buttons, ▲ and ▼, to change the setting.
- ④ Press the SET button.
The buzzer on the remote control signal receiver beeps twice, and the LED lamp flashes four times at two-second intervals.

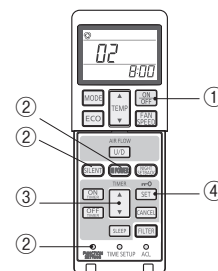

2. Setting details

Button	Number indicator	Function setting
SILENT	00	Infrared sensor setting (Motion sensor setting) : Disable
	01	Infrared sensor setting (Motion sensor setting) : Enable
HI POWER	00	Infrared sensor control (Motion sensor control) : Disable
	01	Infrared sensor control (Motion sensor control) : Power control only
	02	Infrared sensor control (Motion sensor control) : Auto OFF only
	03	Infrared sensor control (Motion sensor control) : Power control and Auto OFF

(i) Power saving / comfort control

The set temperature is adjusted according to the presence of people and their amount of activity detected by the infrared (motion) sensor.

MODE:AUTO/COOL/HEAT mode operation

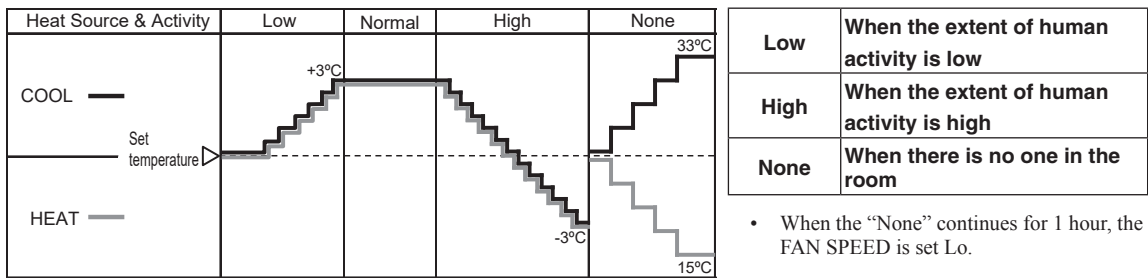

Notes (1) When the following operations are set, power saving control will be canceled.

- ① Energy-saving, Home leave mode, Warm-up control, Cooling operation check.
- ② When the operation mode is changed DRY or FAN.

(2) Not operable while the air-conditioner is OFF.

(ii) Auto-off control

When no activity is detected for 1 hour, unit will go stand-by mode.※ Unit will re-start operation automatically with the original set temperature by activity detection during the stand-by mode. When stand-by mode continues for 12 hours, unit stops.

※ Compressor keeps stopped regardless of the set temperature.

(II) SRK series

(1) Unit ON/OFF button

When the wireless remote control batteries become weak, or if the wireless remote control is lost or malfunctioning, this button may be used to turn the unit on and off.

(a) Operation

Push the button once to place the unit in the automatic mode. Push it once more to turn the unit off.

(b) Details of operation

The unit will go into the automatic mode in which it automatically determines, from indoor temperature (as detected by sensor), whether to go into COOL, DRY or HEAT modes.

Function	Indoor temperature setting	Fan speed	Flap/Louver	Timer switch
Operation mode				
COOL	About 24°C	Auto	Auto	Continuous
DRY				
HEAT				

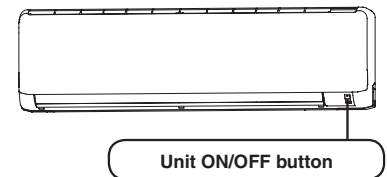

(2) Auto restart function

(a) Auto restart function records the operational status of the air-conditioner immediately prior to be switched off by a power cut, and then automatically resumes operations after the power has been restored.

(b) The following settings will be cancelled:

- (i) Timer settings
- (ii) HIGH POWER operations

- Notes
- (1) Auto restart function is set at on when the air-conditioner is shipped from the factory. Consult with your dealer if this function needs to be switched off.
 - (2) When power failure occurs, the timer setting is cancelled. Once power is resumed, reset the timer.
 - (3) If the jumper wire (JA1) "AUTO RESTART" is cut, auto restart is disabled. (See the diagram at right)

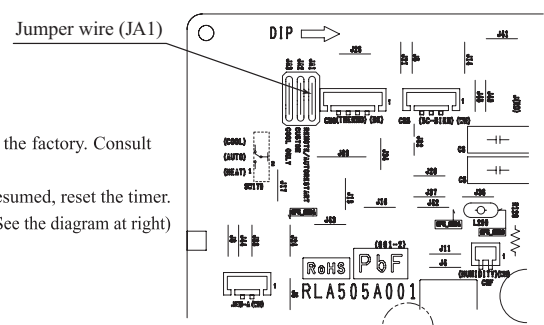

(3) Installing two air-conditioners in the same room

When two air-conditioners are installed in the room, use setting when the two air-conditioners are not operated with one wireless remote control. Set the wireless remote control and indoor unit.

(a) Setting the wireless remote control

- (i) Pull out the cover and take out batteries.
- (ii) Disconnect the switching line next to the battery with wire cutters.
- (iii) Insert batteries, Close the cover.

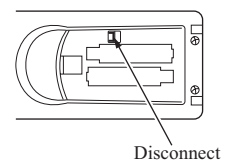

(b) Setting an indoor unit

- (i) Turn off the power source, and turn it on after 1 minute.
- (ii) Point the wireless remote control that was set according to the procedure described on the left side at the indoor unit and send a signal by pressing the ACL switch on the wireless remote control.
Since the signal is sent in about 6 seconds after the ACL switch is pressed, point the wireless remote control at the indoor unit for some time.
- (iii) Check that the reception buzzer sound "Peep" is emitted from the indoor unit.
At completion of the setting, the indoor unit emits a buzzer sound "Peep".
(If no reception tone is emitted, start the setting from the beginning again.)

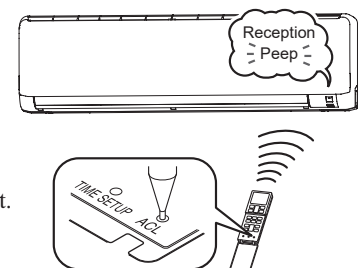

(4) Selection of the annual cooling function

- (a) The annual cooling control is valid from factory default setting. It is possible to disable by cutting jumper wire (JA3), or changing the setting of DIP switch (SW2-4) on the interface kit (Option) PCB if it is connected.

Jumper wire (JA3)	Interface kit (SC-BIKN2-E) SW2-4	Function
Shorted	ON	Enabled factory default setting
Shorted	OFF	Disabled
Open	ON	Disabled
Open	OFF	Disabled

Notes: (1) Default states of the jumper wire (JA3) and the interface kit at the shipping from factory –On the PCB, the DIP switch (SW2-4) is set to enable the annual cooling function.

(2) To cancel the annual cooling setting, consult your dealer.

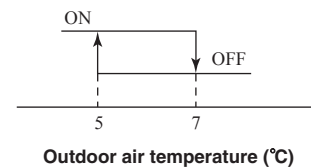
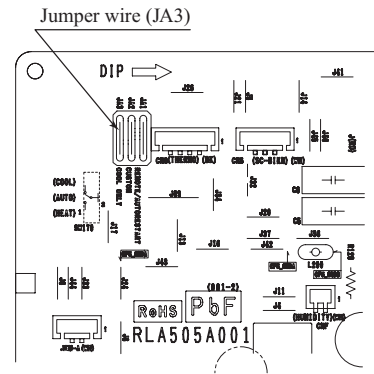

(b) Content of control

- (i) If the outdoor air temperature sensor (TH2) detects below 5°C, the indoor fan speed is switched to 8th step. (It is not possible to change.)
- (ii) If the outdoor air temperature sensor (TH2) detects higher than 7°C, the indoor fan speed is changed to the normal control speed.

(5) High power operation

Pressing the HI/ECO button intensifies the operating power and initiates powerful cooling or heating operation for 15 minutes continuously. The wireless remote control displays HIGH POWER mark and the FAN SPEED display disappears.

- (a) During the HIGH POWER operation, the room temperature is not controlled. When it causes an excessive cooling or heating, press the HI/ECO button again to cancel the HIGH POWER operation.
- (b) HIGH POWER operation is not available during dehumidifying and the program timer operations.
- (c) When HIGH POWER operation is set after setting ON TIMER operation, HIGH POWER operation will start from the set time.
- (d) When the following operation are set, HIGH POWER operation will be canceled.
 - ① When the HI/ECO button is pressed again. (The operation mode will be changed to the ECONOMY operation.)
 - ② When the operation mode is changed.
 - ③ When it has been 15 minutes since HIGH POWER operation has started.
 - ④ When the 3D AUTO button is pressed.
 - ⑤ When the SILENT button is pressed.
 - ⑥ When the NIGHT SETBACK button is pressed.
- (e) Not operable while the air-conditioner is OFF.
- (f) After HIGH POWER operation, the sound of refrigerant flowing may be heard.

(6) Economy operation

Pressing the HI/ECO button initiate a soft operation with the power suppressed in order to avoid an excessive cooling or heating.

The unit operates 1.5°C higher than the setting temperature during cooling or 2.5°C lower than that during heating. The wireless remote control displays ECONO mark and the FAN SPEED display disappears.

- (a) It will go into ECONOMY operation at the next time the air-conditioner runs in the following cases.
 - ① When the air-conditioner is stopped by ON/OFF button during ECONOMY operation.
 - ② When the air-conditioner is stopped in SLEEP or OFF TIMER operation during ECONOMY operation.
 - ③ When the operation is retrieved from SELF CLEAN or ALLERGEN CLEAR operation.
- (b) When the following operation are set, ECONOMY operation will be canceled.
 - ① When the HI/ECO button is pressed again.
 - ② When the operation mode is changed from DRY to FAN.
 - ③ When the NIGHT SETBACK button is pressed.
- (c) Not operable while the air-conditioner is OFF.

(d) The setting temperature is adjusted according to the following table.

(Unit : deg C)

Item	Mode	Cooling	Heating
Temperature adjustment	①	+0.5	-1.0
	②	+1.0	-2.0
	③	1.0+Figure A	-2.0+Figure B

- ① at the start of operation.
- ② one hour after the start of operation.
- ③ two hours after the start of operation.

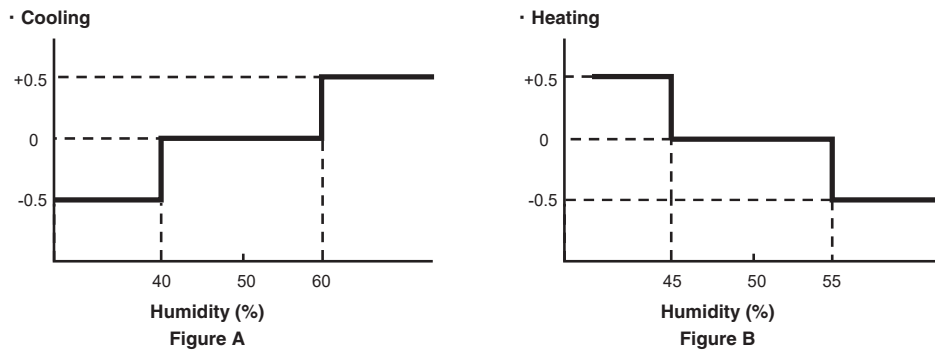

(7) Flap and louver control

Control the flap and louver by AIR FLOW U/D (UP/DOWN) and L/R (LEFT/RIGHT) button on the wireless remote control.

(a) Flap

Each time when you press the AIR FLOW U/D (UP/DOWN) button the mode changes as follows.

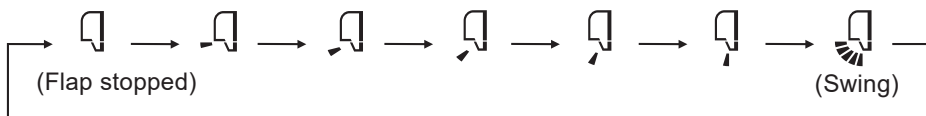

• Angle of Flap from Horizontal

Remote control display					
COOL , DRY, FAN	Approx. 5°	Approx. 20°	Approx. 35°	Approx. 50°	Approx. 70°
HEAT	Approx. 20°	Approx. 35°	Approx. 45°	Approx. 60°	Approx. 70°

(b) Louver

Each time when you press the AIR FLOW L/R (LEFT/RIGHT) button the mode changes as follows.

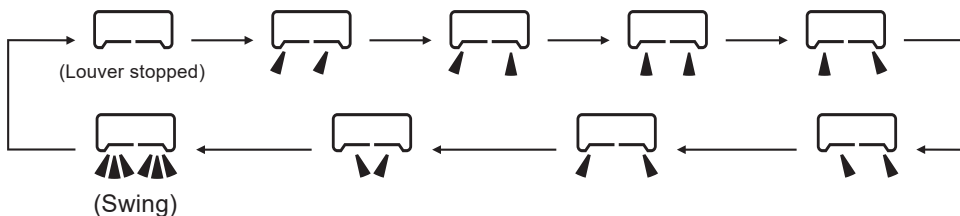

• Angle of Louver

Remote control display					
Center installation	Left approx. 50°	Left approx. 20°	Center	Right approx. 20°	Right approx. 50°
Right end installation	Left approx. 50°	Left approx. 45°	Left approx. 30°	Center	Right approx. 20°
Left end installation	Left approx. 20°	Center	Right approx. 30°	Right approx. 45°	Right approx. 50°

(c) Swing

(i) Swing flap

Flap moves in upward and downward directions continuously.

◆ In HEAT operation

◆ In COOL, DRY, FAN operation

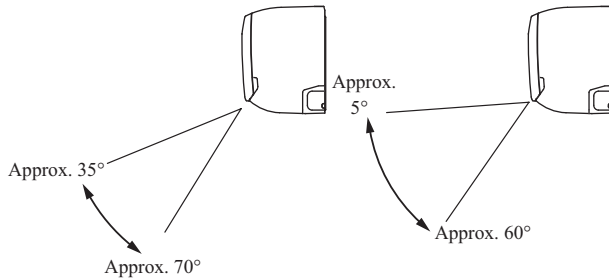

(ii) Swing louver

Louver moves in left and right directions continuously.



(d) Memory flap (Flap or Louver stopped)

When you press the AIR FLOW (UP/DOWN or LEFT/RIGHT) button once while the flap or louver is operating, it stops swinging at the position. Since this angle is memorized in the microcomputer, the flap or louver will automatically be set at this angle when the next operation is started.

(e) When not operating

The flap returns to the position of air flow directly below, when operation has stopped.

(8) 3D auto operation

Control the flap and louver by 3D AUTO button on the wireless remote control.

Air flow selection and air flow direction are automatically controlled, allowing the entire indoor to efficiently conditioned.

(a) During cooling and heating (Including auto cooling and heating)

(i) Air flow selection is determined according to indoor temperature and setting temperature.

Operation mode	Air flow selection					
	AUTO		HI	MED	LO	ULO
Cooling	Indoor temp. – Setting temp. >5°C	Indoor temp. – Setting temp. ≤ 5°C	HI	MED	LO	ULO
	HIGH POWER	AUTO				
Heating	Setting temp. – Indoor temp. >5°C	Setting temp. – Indoor temp. ≤ 5°C	HI	MED	LO	ULO
	HIGH POWER	AUTO				

(ii) Air flow direction is controlled according to the indoor temperature and setting temperature.

1) When 3D auto operation starts

	Cooling	Heating
Flap	Up/down swing	
Louver	Wide (Fixed)	Center (Fixed)

2) When Indoor temp. – Setting temp. is ≤ 5°C during cooling and when Setting temp. – Indoor temp. is ≤ 5°C during heating, the system switches to the following air flow direction control. After the louver swings left and right symmetrically for 3 cycles, control is switched to the control in 3).

	Cooling	Heating
Flap	Horizontal blowing (Fixed)	Slant forward blowing (Fixed)
Louver	Left/right swing	

3) After the flap swings for 5 cycles, control is switched to the control in 4).

	Cooling	Heating
Flap	Up/down swing	
Louver	Center (Fixed)	

4) For 5 minutes, the following air flow direction control is carried out.

	Cooling	Heating
Flap	Horizontal blowing (Fixed)	Slant forwardl blowing (Fixed)
Louver	Wide (Fixed)	

5) After 5 minutes have passed, the air flow direction is determined according to the indoor temperature and setting temperature.

Operation mode	Air flow direction control		
Cooling	Indoor temp. – Setting temp. $\leq 2^{\circ}\text{C}$	$2^{\circ}\text{C} < \text{Indoor temp.} - \text{Setting temp.} \leq 5^{\circ}\text{C}$	Indoor temp. – Setting temp. $> 5^{\circ}\text{C}$
	The control in 4) continues.	Control returns to the control in 2).	Control returns to the control in 1).
Heating	Setting temp. – Indoor temp. $\leq 2^{\circ}\text{C}$	$2^{\circ}\text{C} < \text{Setting temp.} - \text{Indoor temp.} \leq 5^{\circ}\text{C}$	Setting temp. – Indoor temp. $> 5^{\circ}\text{C}$
	The control in 4) continues.	Control returns to the control in 2).	Control returns to the control in 1).

(b) During dehumidifying operation (Including auto dehumidifying operation)

Flap	Horizontal blowing (Fixed)
Louver	Wide (Fixed)

(9) Timer operation

(a) Comfortable timer setting (ON timer)

The unit starts the operation 5 to 60 minutes earlier so that the room can approach optimum temperature at ON timer.

(b) Sleep timer operation

Pressing the SLEEP button causes the temperature to be controlled with respect to the set temperature.

(c) OFF timer operation

The Off timer can be set at a specific time (in 10-minute units) within a 24-hour period.

(d) Weekly timer operation

Timer operation (ON timer, OFF timer) can be set up to 4 times a day for each weekday.

(10) Night setback

As “Night setback” signal is received from the wireless remote control, the heating operation starts with the setting temperature at 10°C.

(11) Installation location setting

When the indoor unit is installed at the end of a room, control the air flow direction so that it is not toward the side walls. If you set the wireless remote control installation position, keep it so that the air flow is within the range shown in the following figure.

(a) Setting

(i) If the air-conditioning unit is running, press the ON/OFF button to stop.

The installation location setting cannot be made while the unit is running.

(ii) Press the AIR FLOW U/D (UP/DOWN) button and the AIR FLOW L/R (LEFT/RIGHT) button together for 5 seconds or more.

The installation location display illuminates.

(iii) Setting the air-conditioning installation location.

Press the AIR FLOW L/R (LEFT/RIGHT) button and adjust to the desired location.

Each time the AIR FLOW L/R (LEFT/RIGHT) button is pressed, the indicator is switched in the order of:

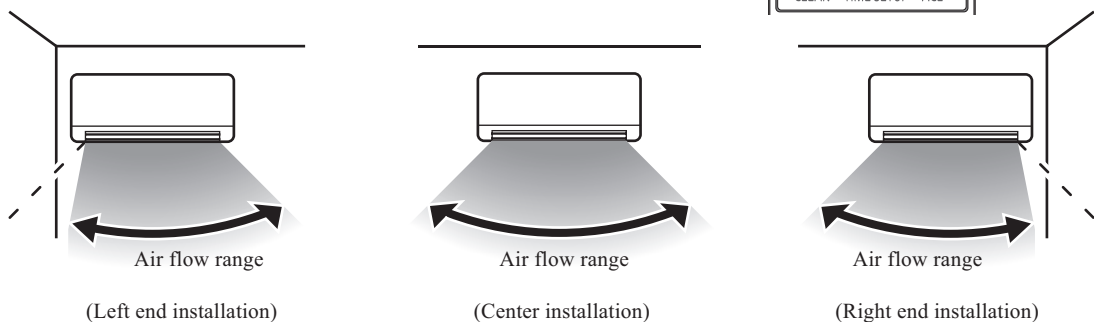
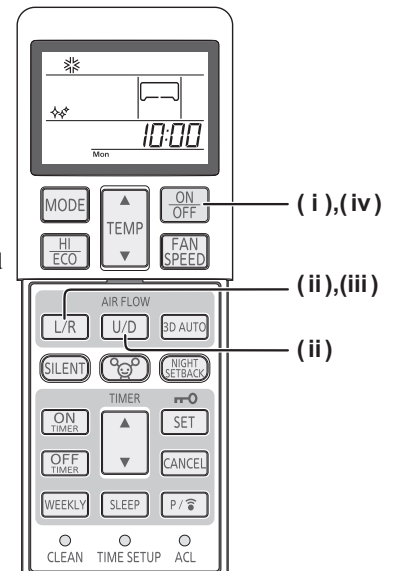

(iv) Press the ON/OFF button.

The air-conditioner's installation location is set.

Press within 60 seconds of setting the installation location (while the installation location setting display illuminates).

(12) Outline of heating operation

(a) Operation of major functional components in heating mode

	Heating		
	Thermostat ON	Thermostat OFF	Failure
Compressor	ON	OFF	OFF
Indoor fan motor	ON	ON(HOT KEEP)	OFF
Outdoor fan motor	ON	OFF (few minutes ON)	OFF
4-way valve	ON	ON	OFF (3 minutes ON)

(b) Details of control at each operation mode (pattern)

(i) Fuzzy operation

Deviation between the indoor temperature setting correction temperature and the return air temperature is calculated in accordance with the fuzzy rule, and used for control of the air capacity and the compressor speed.

Fan speed \ Model	SRK71ZR-W
AUTO	12-120rps
HI	12-120rps
MED	12-120rps
LO	12-98rps
ULO	12-58rps

When the defrosting, protection device, etc. is actuated, operation is performed in the corresponding mode.

(ii) Hot keep operation

If the hot keep operation is selected during the heating operation, the indoor fan motor is controlled based on the temperature of the indoor heat exchanger (Th2) to prevent blowing of cool wind.

(13) Outline of cooling operation

(a) Operation of major functional components in cooling mode

	Cooling		
	Thermostat ON	Thermostat OFF	Failure
Compressor	ON	OFF	OFF
Indoor fan motor	ON	ON	OFF
Outdoor fan motor	ON	OFF (few minutes ON)	OFF (few minutes ON)
4-way valve	OFF	OFF	OFF

(b) Detail of control in each mode (Pattern)

1) Fuzzy operation

During the fuzzy operation, the air flow and the compressor speed are controlled by calculating the difference between the indoor temperature setting correction temperature and the return air temperature.

Fan speed \ Model	SRK71ZR-W
AUTO	12-120rps
HI	12-120rps
MED	12-100rps
LO	12-76rps
ULO	12-50rps

(14) Outline of dry(dehumidifying) operation

(a) Purpose of DRY mode

The purpose is "Dehumidification", and not to control the humidity to the target condition. Indoor/outdoor unit control the operation condition to reduce the humidity, and also prevent over cooling.

(b) Outline of control

(i) Indoor unit fan speed and compressor are controlled by the area which is selected by the temperature difference.

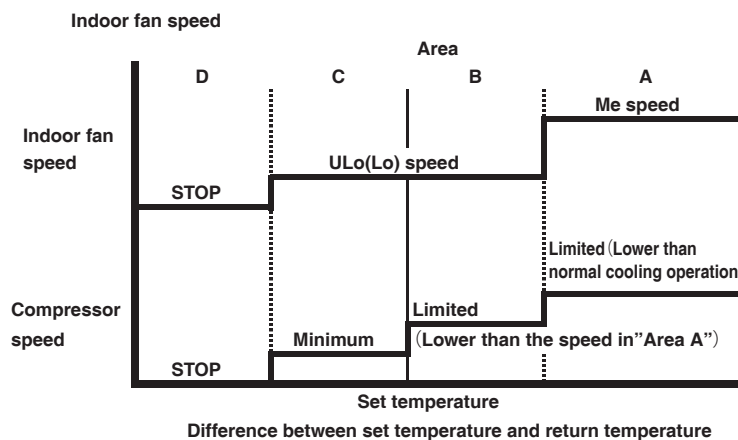

(ii) The indoor unit check the current area by every 5 minutes, and operate by the next checking.

(c) Other

When the outside temperature and room temperature is low for cooling operation, indoor unit can not operate in cooling, and dehumidifying. In this case, the units operate in heating to rise the room temperature and after that start dehumidifying operation.

(15) Outline of automatic operation

(a) Determination of operation mode

Operation mode is determined by indoor air temperature and outdoor air temperature as following.

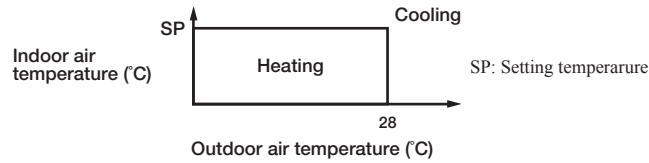

(b) Operation mode is changes when keep cooling and heating thermostat off 20 minutes and be satisfied with following conditions.

If the setting temperature is changed with the remote control, the operation mode is judged immediately.

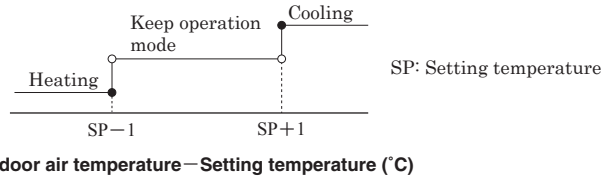

※It can not be changed to heating mode if outdoor air temperature is 28°C or higher.

(c) When the unit is started again within one hour after the stop of automatic operation or when the automatic operation is selected during heating, cooling or DRY mode, the unit is operated in the previous operation mode.

(d) Setting temperature can be adjusted within the following range. There is the relationship as shown below between the signals of the wireless remote control and the setting temperature.

Unit : °C

		Signals of wireless remote control (Display)												
		-6	-5	-4	-3	-2	-1	±0	+1	+2	+3	+4	+5	+6
Setting temperature	Cooling	18	19	20	21	22	23	24	25	26	27	28	29	30
	Heating	18	19	20	21	22	23	24	25	26	27	28	29	30

(16) Protection control function

(a) Dew prevention control [Cooling]: Prevents dewing on the indoor unit.

(i) Operating conditions

When the following conditions have been satisfied for more than 30 minutes after starting operation.

- 1) Compressor's command speed is 28 rps or higher.
- 2) Detected value of humidity is 68% or higher.

(ii) Contents of operation

1) Air capacity control

	Model	SRK71ZR-W
Item	Range A	Follow the table below
Upper limit of compressor's command speed ⁽¹⁾	Range B	54 rps

Note (1) **Ranges A and B** are as shown below.

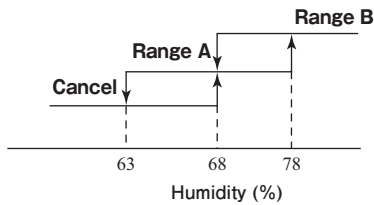

● **Condition for Range A**

Compressor's command speed is controlled according to the indoor unit heat exchanger temperature (Th2) and the indoor unit room temperature (Th1).

Condition	Compressor's command speed
$Th2 \leq Th1 - 10$	<ul style="list-style-type: none"> Decreases the compressor's target max speed by 4 rps. If the condition is met still 20 seconds later, the speed is decreased further by 4 rps. This process is repeated further so far as the condition is met. (Lower limit is 30 rps.)
$Th1 - 10 < Th2 \leq Th1 - 6$	Compressor's target max. speed or changed value of the same is maintained.
$Th2 - 6 < Th1$	Changed compressor's target max. speed is increased at a rate of 1 rps/20 seconds.

- 2) When this control has continued for more than 30 minutes continuously, the following wind direction control is performed.
- When the vertical wind direction is set at other than the vertical swing, the flaps change to the horizontal position.
 - When the horizontal wind direction is set at other than the horizontal swing, the louver changes to the vertical position.

(iii) Reset conditions

When any of followings is satisfied.

- Compressor's command speed is less than 28 rps.
- Detected value of humidity is less than 63%.

(b) Frost prevention control (During cooling or dehumidifying)

(i) Operating conditions

- Indoor heat exchanger temperature (Th2) is lower than 5°C.
- 5 minutes after reaching the compressor command speed except 0 rps.

(ii) Detail of anti-frost operation

Indoor heat exchanger temperature	5°C or lower	2.5°C or lower
Item		
Lower limit of compressor command speed	22 rps	0 rps
Indoor fan	Depends on operation mode	Protects the fan tap just before frost prevention control
Outdoor fan	Depends on command speed	
4-way valve	OFF	Depends on stop mode

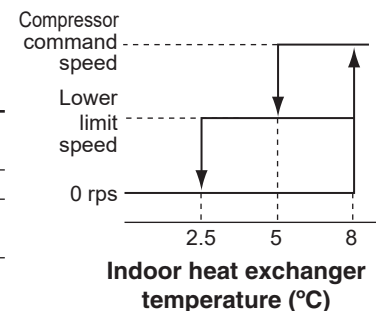

- Notes
- When the indoor heat exchanger temperature is in the range of 2.5-5°C, the speed is reduced by 4 rps at each 20 seconds.
 - When the temperature is lower than 2.5°C, the compressor is stopped.
 - When the indoor heat exchanger temperature is in the range of 5-8°C, the compressor command speed is been maintained.

(iii) Reset conditions

When either of the following condition is satisfied.

- The indoor heat exchanger temperature (Th2) is 8°C or higher.
- The compressor command speed is 0 rps.

(c) Indoor fan motor protection

When the air-conditioner is operating and the indoor fan motor is turned ON, if the indoor fan motor has operated at 300 min^{-1} or under for more than 30 seconds, the unit enters first in the stop mode and then stops the entire system.

1.1.4 Operation control function by the outdoor control Model FDC71VNX-W

(1) Determination of compressor speed (Frequency)

Required frequency

(a) Cooling/dehumidifying operation Unit: rps

Model		FDC71
Max. required frequency	Normal mode	105
	Capacity save mode	48
Min. required frequency		11

(b) Heating operation Unit: rps

Model		FDC71
Max. required frequency	Normal mode	120
	Capacity save mode	60
Min. required frequency		12

- (c) If the indoor fan speed becomes “Me” or “Lo”, Max required frequency goes down accordingly depending on indoor unit model.
- (d) Max. required frequency under high outdoor air temperature in cooling mode.
Maximum required frequency is selected according to the outdoor air temperature (Tho-A).

Unit: rps

Model		FDC71
Max. required frequency	Outdoor air temperature is 37°C or higher	80
	Outdoor air temperature is 40°C or higher	63
	Outdoor air temperature is 46°C or higher	50

- (e) Max. required frequency under outdoor air temperature in heating mode.
Maximum required frequency is selected according to the outdoor air temperature (Tho-A).

Unit: rps

Model		FDC71
Max. required frequency	Outdoor air temperature is 18°C or higher	76

- (f) Selection of max. required frequency by heat exchanger temperature.
 - (i) Maximum required frequency is selected according to the outdoor heat exchanger temperature (Tho-R) during cooling/dehumidifying or according to the indoor heat exchanger temperature (Thi-R) during heating mode.
 - (ii) When there are 3 indoor heat exchanger temperatures (Thi-R), whichever the highest applies,

Unit: rps

Model			FDC71
Max. required frequency	Cooling/dehumidifying	Outdoor heat exchanger temperature is 61°C or higher	60
		Indoor heat exchanger temperature is 47°C or higher	110
	Heating	Indoor heat exchanger temperature is 54°C or higher	100
		Indoor heat exchanger temperature is 60°C or higher	90

- (g) When any of the controls from (a) to (f) above may duplicate, whichever the smallest value among duplicated controls is taken as the maximum required frequency.
- (h) During heating, it is operated with the maximum required frequency until the indoor heat exchanger temperature becomes 40°C or higher.

(2) Compressor start control

- (a) Compressor starts upon receipt of the thermostat ON signal from the indoor unit.
- (b) However, at initial start after turning the power source breaker, it may enter the standby state for maximum 30 minutes (“ PREPARATION” is displayed on the remote control) in order to prevent the oil loss in the compressor.

If the cooling/dehumidifying/heating operation is selected from the remote control when the outdoor unit is in the standby state, “ PREPARATION” is displayed for 3 seconds on the remote control.

(3) Compressor soft start control

(a) Compressor protection start I

[Control condition]

Normally, the compressor operation frequency is raised in this start pattern.

[Control contents]

- (i) Starts with the compressor’s target frequency at **A** rps.

However, when the outdoor air temperature (Tho-A) is 35°C or higher during cooling/dehumidifying or the indoor return air temperature (Thi-A) is 25°C or higher during heating, it starts at **C** rps.

- (ii) At 30 seconds after the start of compressor, its target frequency changes to **B** rps and the compressor is operated for 2 - 4 minutes with its operation frequency fixed at **B** rps.

Model	Operation mode	A rps	B rps	C rps
FDC71	Cooling/Dehumidifying	45	45	30
	Heating	45	45	30

(b) Compressor protection start III

[Control condition]

Number of compressor starts is only 1 counted after the power source breaker ON.

[Control contents]

Operates by selecting one of following start patterns according to the operation mode and the outdoor air temperature (Tho-A).

- (i) Low frequency operation control during cooling/dehumidifying

[Control condition]

Upon establishing the conditions of compressor protection start III, the low frequency operation control is performed during cooling/dehumidifying.

[Control contents]

- 1) Starts with the compressor’s target frequency at **A** rps. When the outdoor air temperature (Tho-A) is 35°C or higher, it starts at **C** rps.
- 2) At 30 seconds after the compressor start, the compressor’s target frequency is changed to **B** rps and the compressor’s operation frequency is fixed for 10 minutes.

Model	Operation mode	A rps	B rps	C rps
FDC71	Cooling/Dehumidifying	45	45	30

- (ii) Low frequency operation control during heating

[Control condition]

When the conditions of compressor protection start III are established and one of following conditions 1) is satisfied, the low number of revolutions operation control is performed during heating.

- 1) At 30 minutes or more after turning the power source breaker on.

[Control contents]

- 1) Starts the compressor with its target frequency at **A** rps. However, when the indoor return air temperature (Thi-A) is 25°C or higher, it start at **C** rps.
- 2) At 30 seconds after the start of compressor, the compressor’s target frequency is changed to **B** rps and the compressor’s operation frequency is fixed for 10 minutes.

Model	Operation mode	A rps	B rps	C rps
FDC71	Heating	45	45	30

(4) Outdoor fan control

(a) Outdoor fan tap and fan motor speed

Unit: min⁻¹

Model	Mode	Fan motor tap						
		① speed	② speed	③ speed	④ speed	⑤ speed	⑥ speed	⑦ speed
FDC71	Cooling/Dehumidifying	200	400	600	710	810	850	950
	Heating	200	400	600	710	810	850	950

(b) Fan tap control during cooling/defumidifying operation

Fan taps are selected depending on the outdoor heat exchanger temperature (Tho-R1, R2) and the outdoor air temperature (Tho-A).
 Note (1) It is detected by Tho-R1 or R2, whichever the higher.

	(A) zone	(B) zone	(C) zone	(D) zone
(a) zone	Tap 6	Tap 6	Tap 6	Tap 4
(b) zone	Tap 6	Tap 6	Tap 6	Tap 3
(c) zone	Tap 4	Tap 4	Tap 3	Tap 2
(d) zone	Tap 3	Tap 3	Tap 2	Tap 1

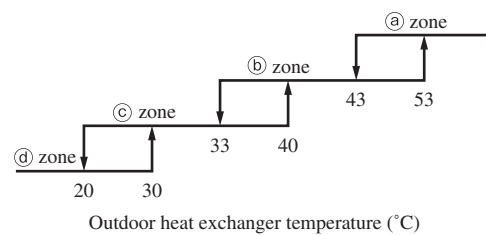
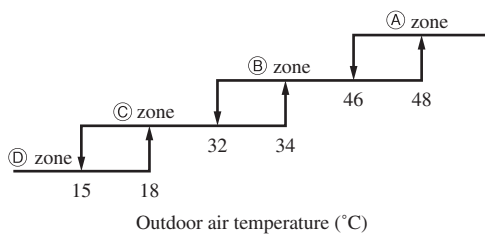

(c) Fan tap control during heating operation

Fan taps are selected depending on the outdoor heat exchanger temperature (Tho-R1, R2) and the outdoor air temperature (Tho-A).
 Note (1) It is detected by Tho-R1 or R2, whichever the lower.

	(A) zone	(B) zone	(C) zone
(a) zone	Tap 1	Tap 1	Tap 2
(a) zone	Tap 2	Tap 2	Tap 3
(b) zone	Tap 3	Tap 3	Tap 4
(c) zone	Tap 3	Tap 4	Tap 5
(d) zone	Tap 4	Tap 5	Tap 6

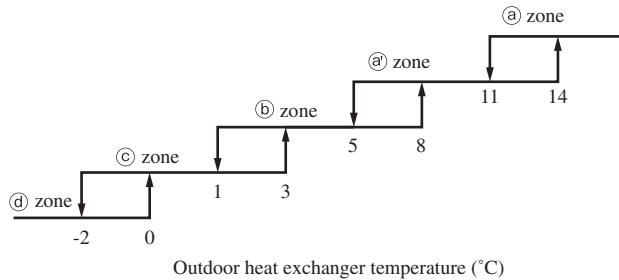
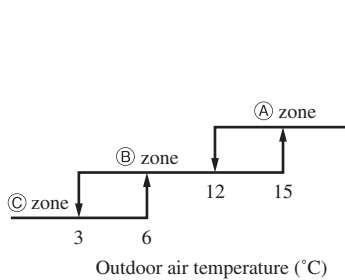

(d) Outdoor fan control at cooling low outdoor air temperature

- (i) When all the following conditions are established after the start of compressor, the following control is implemented. If the outdoor air temperature (Tho-A) is in the zone (B) in the cooling/defumidifying mode, it has elapsed 20 seconds from the start of outdoor fan and the outdoor fan is at the tap 1 speed, the outdoor fan speed is controlled according to the outdoor heat exchanger temperature (Tho-R1, R2).

Note (1) It is detected with Tho-R1 or R2, whichever the higher.

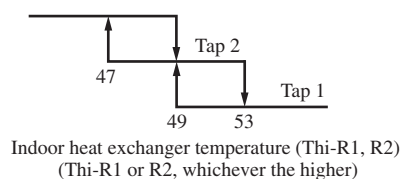
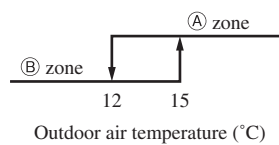

- (ii) The outdoor heat exchanger temperature is detected always and, when the number of revolutions of the outdoor fan speed has been increased or decreased, there is no change of fan speed for 20 seconds.

(5) Defrost operation

(a) Starting conditions

If all of the following defrost conditions A or conditions B are satisfied, the defrost operation starts.

(i) Defrost conditions A

- 1) Cumulative compressor operation time after the end of defrost operation has elapsed 37 minutes, and the cumulative compressor operation time after the start of heating operation (remote control ON) has elapsed 30 minutes.
- 2) After 5 minutes from the compressor ON
- 3) After 5 minutes from the start of outdoor fan
- 4) After satisfying all above conditions, if

temperatures of the outdoor heat exchanger temperature sensor (Tho-R1, R2) and the outdoor air temperature sensor (Tho-A) become lower than the defrost operation starting temperature as shown by the right figure for 15 seconds continuously, or the suction gas saturation temperature (SST) and the outdoor air temperature (Tho-A), which are obtained from the value detected by the low pressure sensor (LPT) stay for 3 minutes within the range below the defrost operation start temperature as shown by the right figure. However, it excludes for 10 minutes after the start of compressor and the outdoor air temperature is as shown by the lower figure.

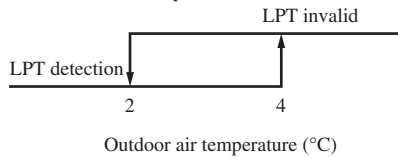
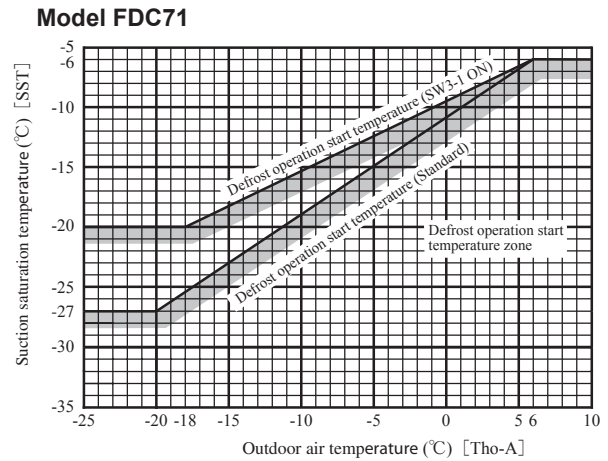

(ii) Defrost conditions B

- 1) When previous defrost ending condition is the time out of defrost operation and it is in the heating operation after the cumulative compressor operation time after the end of defrost operation has become 30 minutes.
- 2) After 5 minutes from the start of compressor
- 3) After 5 minutes from the start of outdoor fan

(b) Ending conditions

When any of the following conditions is satisfied, the heating operation starts.

- (i) When it has elapsed 10 minutes and 20 seconds after the start of defrost operation.
- (ii) When the outdoor heat exchanger temperatures (Tho-R1, R2), whichever the lower, becomes 12°C or higher for 10 seconds continuously.

(c) Switching of defrost control with SW3-1

- (i) If SW3-1 on the outdoor control PCB is turned to ON, it becomes easier to enter the defrost operation. Use this when installing a unit at snowing regions.
- (ii) Control contents
 - 1) It allows entering the defrost operation under the defrost condition A when the cumulative heating operation time becomes 30 minutes. It is 37 minutes at SW3-1 OFF (Factory default).
 - 2) It allows entering the defrost operation under the defrost condition B when the cumulative heating operation time becomes 25 minutes. It is 30 minutes at SW3-1 OFF (Factory default).

(6) Protective control/anomalous stop control by compressor's number of revolutions

(a) Compressor discharge pipe temperature protection

- (i) Protective control
As the discharge pipe temperature (detected with Tho-D) exceeds the setting value, the compressor speed (frequency) is controlled to suppress the rise of discharge pipe temperature.

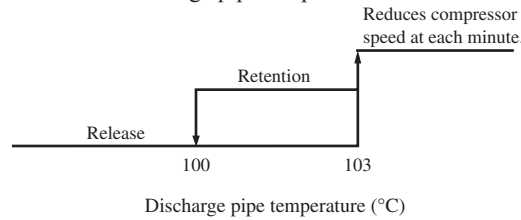

- (ii) Anomalous stop control

- 1) If the discharge pipe temperature (detected with Tho-D) exceeds the setting value, the compressor stops.
- 2) When it is detected 2 times within 60 minutes or after continuous 60 minutes, including the stop of compressor, E36 is displayed on the remote control and it enters the anomalous stop mode.

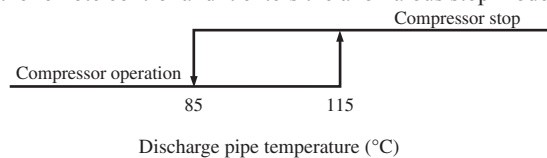

- (iii) Reset of anomalous stop mode

As it drops to the reset value of 85°C or lower for 45 minutes continuously, it becomes possible to restart from the remote control.

(b) Cooling high pressure protection

- (i) Protective control
 - 1) When the outdoor air temperature (Tho-A) is 40°C or higher and the outdoor heat exchanger temperature (Tho-R) exceeds the setting value, the compressor speed (frequency) is controlled to suppress the rise of high pressure.
 - 2) Control value A is updated to an optimum value automatically according to the operating conditions.

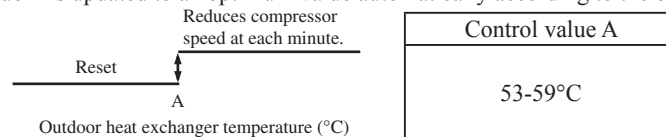

- (ii) Anomalous stop control

- 1) As the outdoor heat exchanger temperature (Tho-R) exceeds the setting value, the compressor stops.
- 2) If it is detected 5 times within 60 minutes or 63°C or higher continues for 30 minutes, including the stop of compressor, E35 is displayed on the remote control and it enters the anomalous stop mode.

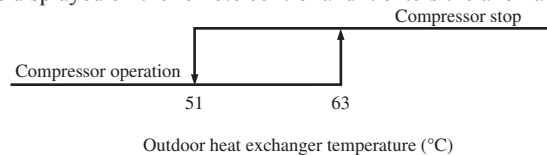

- (iii) Reset of anomalous stop mode

As it reaches the reset value of 51°C or lower, it becomes possible to restart from the remote control.

(c) Heating high pressure protection

- (i) Protective control
 - 1) As the indoor heat exchanger temperature (Thi-R) exceeds the setting value, the compressor speed (frequency) is controlled to suppress the rise of high pressure.
 - 2) Control value A is updated to an optimum value automatically according to the operating conditions.

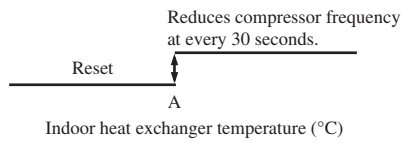

Model	Existing piping adaptation switch: SW5-1	
	OFF (Shipping)	ON
	Control value A (°C)	
FDC71	48-54	45-51

Note (1) Adaptation to existing piping is at ON.

- (ii) Anomalous stop control
Operation control function by the indoor unit control - See the heating overload protection, page 20.
- (iii) Adaptation to existing piping, stop control
If the existing piping adaptation switch, SW5-1, is turned ON, the compressor stops to protect existing piping when the indoor heat exchanger temperature (Thi-R) exceeds the setting value.

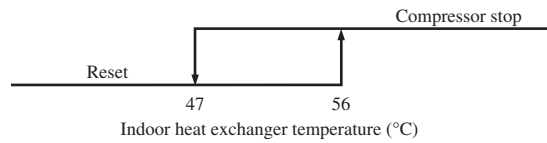

(d) Anomaly detection control by the high pressure switch (63H1)

- (i) If the pressure rises and operates the high pressure switch (opens at 4.15MPa/closes at 3.15MPa), the compressor stops.
- (ii) Under any of the following conditions, E40 is displayed and it enters the anomalous stop mode.
 - 1) When it occurs 5 times within 60 minutes that pressure rises and the compressor is stopped by 63H1.
 - 2) When 63H1 has been in the open state for 30 minutes continuously, including the stop of compressor.

(e) Low pressure control

- (i) Protective control
If the value detected by the low pressure sensor (LPT) exceeds the setting value, the compressor speed (frequency) is controlled to restrain the drop of pressure.

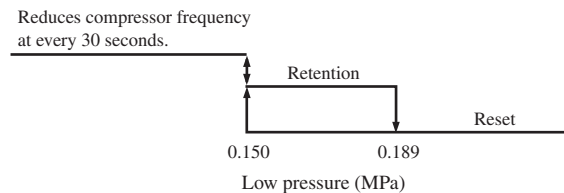

- (ii) Anomalous stop control
 - 1) When a value detected by the low pressure sensor (LPT) satisfies any of the following conditions, the compressor stops to run for its protection.
 - a) When the low pressure drops to 0.079MPa or under for 15 seconds continuously.
 - b) At 10 minutes after the start of compressor, the suction overheat becomes 30°C and the low pressure becomes 0.15MPa or under for 60 seconds continuously.
 - 2) E49 is displayed under any of the following conditions and it enters the anomalous stop mode.
 - a) When the low pressure drops 5 times within 60 minutes and the compressor stops under any of the above conditions.
 - b) When a value detected with the low pressure sensor becomes 0.079MPa or under for 5 minutes, including the stop of compressor.
 - 3) However, when the control condition 1). a) is established during the compressor protection start III, E49 is displayed at initial stop and it enters the anomalous stop mode.

(f) Over-current protection current safe controls I, II

Detecting the outdoor inverter input (primary) current and the output (secondary) current, if the current values exceed setting values, the compressor speed (frequency) is controlled to protect the inverter.

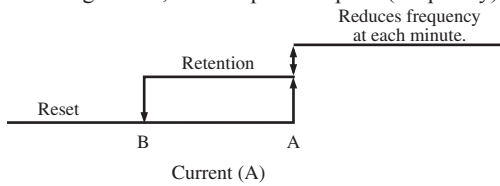

Model	Cooling		Heating	
	Control value A	Reset value B	Control value A	Reset value B
Primary current side FDC71	18.0	17.0	18.0	17.0
Secondary current side FDC71	※ 1	※ 2	10.0	9.0

- ※ 1 It is controlled with 7 - 8A according to outdoor air temperature
- ※ 2 6 - 7A according to outdoor air temperature

(g) Anomalous power transistor current

- (i) Prevents over-current on the inverter. If the current value in the power transistor exceeds the setting value, the compressor stops.
- (ii) If the current value in the power transistor exceeds the specified value and the compressor stops 4 times within 30 minutes, E42 is displayed on the remote control and it enters the anomalous stop mode.

(h) Anti-frost control by the compressor frequency control

- (i) If the indoor heat exchanger temperature (detected with Thi-R) exceeds the setting value at 4 minutes after the start of compressor, the compressor speed (frequency) is controlled to initiate the anti-frost control of indoor heat exchanger.
- (ii) When there are 2 indoor heat exchanger temperatures (Thi-R), the lowest temperature is detected.

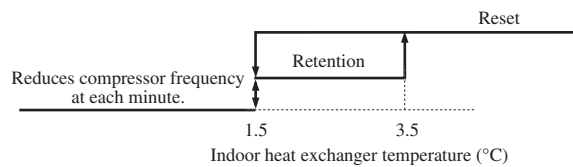

- (iii) Regarding the anti-frost control by the operation stop, refer to the operation control function by the indoor control and the cooling, dehumidifying frost prevention of page 20.

(i) Refrigerant quantity shortage protection

Under the compressor protection start III control during cooling and dehumidifying operations, the following control is performed by detecting the indoor heat exchanger temperature (Thi-R) and the indoor return air temperature (Thi-A).

[Control condition]

When the state that the indoor heat exchanger temperature (Thi-R) does not become lower than the indoor return air temperature (Thi-A) by 4°C or more continues for 1 minute.

[Control contents]

It judges that the flowing of refrigerant in to the indoor unit is insufficient so that the compressor is stopped and E57 is displayed on the remote control.

(j) Broken wire detection on temperature sensor and low pressure sensor

- (i) Outdoor heat exchanger temperature sensor, outdoor air temperature sensor and low pressure sensor

If the following is detected for 5 second continuously within 2 minutes to 2 minutes and 20 seconds after the compressor ON, the compressor stops. After a delay of 3 minutes, it restarts but, if the same is detected repeatedly 3 times within 40 minutes, the compressor stops with the anomalous stop.

Note (1) During defrost operation and for 3 minutes after the end of defrost operation, it is not detected.

- Outdoor heat exchanger temperature sensor: -50°C or lower
- Outdoor air temperature sensor: -45°C or lower
- Low pressure sensor: 0V or under or 4.0V or over

- (ii) Discharge pipe temperature sensor, suction pipe temperature sensor

If the following is detected for 5 seconds continuously within 10 minutes to 10 minutes and 20 seconds after the compressor ON, the compressor stops. After a delay of 3 minutes, it restarts but, if the same is detected repeatedly 3 times within 40 minutes, the compressor stops with the anomalous stop.

Note (1) During defrost operation and for 3 minutes after the end of defrosting, it is not detected.

- Discharge pipe temperature sensor: -10°C or lower
- Suction pipe temperature sensor: -50°C or lower

(k) Fan motor error

- (i) If the fan speed of 100min⁻¹ or under is detected for 30 seconds continuously under the outdoor fan control (with the operation command of fan tap at ① speed or higher), the compressor stops.
- (ii) When the fan motor speed drops to 100min⁻¹ or under 5 times within 60 minutes and the compressor stops, it enters the anomalous stop mode with E48 displayed on the remote control.

(l) Anomalous stop by the compressor start stop

- (i) When it fails to shift to the compressor DC motor's rotor position deflection operation at 5 seconds after establishing the compressor starting condition, the compressor stops temporarily and restarts 3 minutes later.
- (ii) If it fails to shift to the position detection operation again at second time, it judges the anomalous compressor start and stops the compressor by the anomalous stop (E59).

(7) Silent mode

- (a) As "Silent mode start" signal is received from the remote control, it operates by dropping the outdoor fan tap and the compressor speed (frequency).
- (b) For details, refer to items (1) and (4) above.

(8) Test run

- (a) It is possible to operate from the outdoor unit using the DIP switch on the outdoor unit control PCB.

SW5-3	ON	SW5-4	OFF	Cooling test run
			ON	Heating test run
	OFF	Normal and end of test run		

Make sure to turn SW5-3 to OFF after the end of operation.

(b) Test run control

- (i) Operation is performed at the maximum compressor speed (frequency), which is determined for each model.
- (ii) Each protective control and error detection control are effective.
- (iii) If SW5-4 is switched during test run, the compressor is stopped for once by the stop control and the cooling/heating operation is switched.
- (iv) Setting and display of remote control during test run

Mode	Item	Contents of remote control setting/display
Cooling test run		Setting temperature of cooling is 5°C.
Heating test run		Setting temperature of heating (preparation) is 30°C.

(9) Pump-down control

Pump-down operation starts 2 seconds after SW9 switch is turned on during the operation stop or anomalous stop (excluding thermostat OFF) while SW8-3 switch is off. (This is invalid when the indoor unit is operating. This is effective even when the indoor unit is stopped by the anomalous stop or the power source is turned OFF.)

(a) Control contents

- (i) Close the service valve at the liquid side. (It is left open at the gas side.)
- (ii) Compressor is started with the target speed (frequency) at 45 rps in the cooling mode.
- (iii) Red and green lamps (LED) lash continuously on the outdoor unit control PCB.
- (iv) Each of protection and error detection controls, excluding the low pressure control, anti-frost control and dewing prevention control, is effective.
- (v) Outdoor fan is controlled as usual.
- (vi) Electronic expansion valve is fully opened.

(b) Control ending conditions

Stop control is initiated depending on any of the following conditions.

- (i) Low pressure of 0.087MPa or lower is detected for 5 seconds continuously.
 - 1) Red LED: Light, Green LED: Flashing, Remote control: Displays stop.
 - 2) It is possible to restart when the low pressure is 0.087MPa or higher.
 - 3) Electronic expansion valve (cooling/heating) is kept fully open.
- (ii) Stop by the error detection control
 - 1) Red LED: Keeps lashing, Green LED: Flashing
 - 2) Restart is prohibited. To return to normal operation, reset the power source.
 - 3) Electronic expansion valve (cooling/heating) is left fully open.
- (iii) When the cumulative operation time of compressor under the pump-down control becomes 5 minutes.
 - 1) Red LED: Stays OFF, Green LED: Flashing, Remote control: Stop
 - 2) It is possible to pump-down again.
 - 3) Electronic expansion valve (cooling/heating) is left fully open.

Note (1) After the stop of compressor, close the service valve at the gas side.

Caution: Since pressing the pump-down switch cancels communications with the indoor unit, the indoor unit and the remote control display “Transmission error – E5”. This is normal.

1.2 MAINTENANCE DATA

1.2.1 FDT, FDTc, FDU, FDUM, FDE series

1.2.1.1 Diagnosing of microcomputer circuit

(1) Selfdiagnosis function

(a) Check indicator table

Whether a failure exists or not on the indoor unit and outdoor unit can be know by the contents of remote control error code, indoor/outdoor unit green LED (power pilot lamp and microcomputer normality pilot lamp) or red LED (check pilot lamp).

(i) Indoor unit

Remote control		Indoor unit control PCB		Outdoor unit control PCB		Location of trouble	Description of trouble	Repair method	Reference page
Error code	Red LED	Red LED	Green LED (1)	Red LED	Green LED (1)				
No-indication	Stays OFF	Stays OFF	Keeps flashing	Stays OFF	Keeps flashing	—	• Normal operation	—	—
		Stays OFF	Stays OFF	2-time flash	Stays OFF	Indoor unit power source	• Power OFF, broken wire/blown fuse, broken transformer wire	Repair	78
		* 3-time flash	Keeps flashing	Stays OFF	Keeps flashing	Remote control wires	• Poor connection, breakage of remote control wire * For wire breaking at power ON, the LED is OFF.	Repair	79
				Remote control	• Defective remote control PCB	Replacement of remote control			
WAIT or INSPECT I/U	Stays OFF	Keeps flashing	2-time flash	Keeps flashing	Indoor-outdoor units connection wire	• Poor connection, breakage of indoor-outdoor units connection wire	Repair	80-84	
					Remote control	• Improper setting of master and slave by remote control			
E1	Stays OFF	* Keeps flashing	Stays OFF	Keeps flashing	Remote control wires (Noise)	• Poor connection of remote control signal wire (White) * For wire breaking at power ON, the LED is OFF	Repair	86	
					Remote control indoor unit control PCB	• Intrusion of noise in remote control wire * Defective remote control or indoor unit control PCB (defective communication circuit)?			
E5	2-time flash	Keeps flashing	2-time flash	Keeps flashing	Indoor-outdoor units connection wire	• Poor connection of wire between indoor-outdoor units during operation (disconnection, loose connection)	Repair	87	
					(Noise)	• CPU-runaway on outdoor control PCB			
					Outdoor unit control PCB	* Occurrence of defective outdoor unit control PCB on the way of power source (defective communication circuit)?			
E6	1-time flash	Keeps flashing	Stays OFF	Keeps flashing	Outdoor unit control PCB	• Defective outdoor unit control PCB on the way of power source	Replacement		
					Fuse	• Blown fuse			
E7	1-time flash	Keeps flashing	Stays OFF	Keeps flashing	Indoor heat exchanger temperature sensor	• Defective indoor heat exchanger temperature sensor (defective element, broken wire, short-circuit)	Replacement, repair of temperature sensor	88	
					Indoor unit control PCB	* Defective indoor unit control PCB (Defective temperature sensor input circuit)?			
E8	1-time flash	Keeps flashing	Stays OFF	Keeps flashing	Indoor return air temperature sensor	• Defective indoor return air temperature sensor (defective element, broken wire, short-circuit)	Replacement, repair of temperature sensor	89	
					Indoor unit control PCB	* Defective indoor unit control PCB (Defective temperature sensor input circuit)?			
E9	1-time flash	Keeps flashing	Stays OFF	Keeps flashing	Installation or operating condition	• Heating over-load (Anomalously high indoor heat exchanger temperature)	Repair	90	
					Indoor heat exchanger temperature sensor	• Defective indoor heat exchanger temperature sensor (short-circuit)			
					Indoor unit control PCB	* Defective indoor unit control PCB (Defective temperature sensor input circuit)?			
E10	1-time flash	Keeps flashing	Stays OFF	Keeps flashing	Drain trouble	• Defective drain pump (DM), broken drain pump wire, disconnected connector	Replacement, repair of DM	91	
					Float switch	• Anomalous float switch operation (malfunction)			
					Indoor unit control PCB	* Defective indoor unit control PCB (Defective float switch input circuit)			
					Option	• Defective option parts (At option anomalous input setting)			
E11	Stays OFF	Keeps flashing	Stays OFF	Keeps flashing	Address setting error	• Address setting error of indoor units	Repair	93	
E14	3-time flash	Keeps flashing	Stays OFF	Keeps flashing	Indoor unit No. setting	• No master is assigned to slaves.	Repair	94	
					Rremote control wires	• Anomalous remote control wire connection, broken wire between master and slave units			
E16	1(2)-time flash	Keeps flashing	Stays OFF	Keeps flashing	Indoor fan motor	• Defective indoor fan motor	Replacement, repair	95	
					Indoor unit power PCB	• Defective indoor unit power PCB			
E18	1-time flash	Keeps flashing	Stays OFF	Keeps flashing	Address setting error	• Address setting error of master and slave indoor units	Repair	96	
E19	1-time flash	Keeps flashing	Stays OFF	Keeps flashing	Indoor unit control PCB	• Indoor unit operation check error	Repair	97	
E20	1(2)-time flash	Keeps flashing	Stays OFF	Keeps flashing	Indoor fan motor	• Indoor motor rotation speed anomaly	Replacement, repair	98	
					Indoor unit power PCB	• Defective indoor unit power PCB			
E28	Stays OFF	Keeps flashing	Stays OFF	Keeps flashing	Remote control temperature sensor	• Broken wire of remote control temperature sensor	Repair	99	

Notes (1) Normal indicator lamp (Indoor, outdoor units: Green) extinguishes (or lights continuously) only when CPU is anomalous. It keeps flashing in any trouble other than anomalous CPU.

(2) * mark in the description of trouble means that, in ordinary diagnosis, it cannot identify the cause definitely, and, if the trouble is repaired by replacing the part, it is judged consequently that the replaced part was defective.

(ii) Outdoor unit
FDC71VNX-W

Remote control		Indoor unit control PCB		Outdoor unit control PCB		Outdoor inverter PCB	Location of trouble	Description of trouble	Repair method	Reference page
Error code	Red LED	Red LED	Green LED (f)	Red LED	Green LED (f)	Yellow LED				
E35		Stays OFF	Keeps flashing	1-time flash	Keeps flashing		Installation or operating condition	• Higher outdoor heat exchanger temperature	Repair	100
							Outdoor heat exchanger temperature sensor	• Defective outdoor heat exchanger temperature sensor	Replacement of temperature sensor	
							Outdoor unit control PCB	*• Defective outdoor unit control PCB (Defective temperature sensor input circuit)?	Replacement of PCB	
E36		Stays OFF	Keeps flashing	1-time flash	Keeps flashing		Installation or operating condition	• Higher discharge temperature	Repair	101
							Discharge pipe temperature sensor	• Defective discharge pipe temperature sensor	Replacement, repair of temperature sensor	
							Outdoor unit control PCB	*• Defective outdoor unit control PCB (Defective temperature sensor input circuit)?	Replacement of PCB	
E37		Stays OFF	Keeps flashing	1-time flash	Keeps flashing	Keeps flashing	Outdoor heat exchanger temperature sensor	• Defective outdoor heat exchanger temperature sensor, broken wire or poor connector connection	Replacement, repair of temperature sensor	102
							Outdoor unit control PCB	*• Defective outdoor unit control PCB (Defective temperature sensor input circuit)?	Replacement of PCB	
E38		Stays OFF	Keeps flashing	1-time flash	Keeps flashing		Outdoor air temperature sensor	• Defective Outdoor air temperature sensor, broken wire or poor connector connection	Replacement, repair of temperature sensor	103
							Outdoor unit control PCB	*• Defective outdoor unit control PCB (Defective temperature sensor input circuit)?	Replacement of PCB	
E39		Stays OFF	Keeps flashing	1-time flash	Keeps flashing		Discharge pipe temperature sensor	• Defective discharge pipe temperature sensor, broken wire or poor connector connection	Replacement, repair of temperature sensor	104
							Outdoor unit control PCB	*• Defective outdoor unit control PCB (Defective temperature sensor input circuit)?	Replacement of PCB	
E40		Stays OFF	Keeps flashing	1-time flash	Keeps flashing		Installation or operating condition	• Rising high pressure (Operation of 63H1) • Service valve closing operation	Repair	105
							Outdoor unit control PCB	*• Defective outdoor unit control PCB (Defective 63H input circuit)?	Replacement of PCB	
E41		Stays OFF	Keeps flashing	1-time flash	Keeps flashing	6-time flash	Inverter PCB or radiator fin	• Power transistor overheat	Replacement of PCB or Repair	106
E42		Stays OFF	Keeps flashing	1-time flash	Keeps flashing	1-time flash	Outdoor unit control PCB compressor	• Current cut (Anomalous compressor over-current)	Replacement of PCB	107•108
							Installation or operating condition	• Service valve closing operation	Repair	
E45		Stays OFF	Keeps flashing	1-time flash	Keeps flashing	Keeps flashing	Outdoor unit control PCB	• Anomalous outdoor unit control PCB communication	Replacement of PCB	109
							Inverter PCB	• Anomalous inverter PCB communication		
E47		Stays OFF	Keeps flashing	1-time flash	Keeps flashing	7-time flash	Inverter PCB active filter	• Defective inverter PCB Defective active filter of control	Replacement	110
E48		Stays OFF	Keeps flashing	1-time flash	Keeps flashing		Outdoor fan motor	• Anomalous outdoor fan motor	Replacement, repair	111
							Outdoor unit control PCB	*• Defective outdoor unit control PCB (Defective motor input circuit)?	Replacement of PCB	
							Installation or operating condition	• Low pressure error • Service valve closing operation	Repair	
E49		Stays OFF	Keeps flashing	1-time flash	Keeps flashing	Keeps flashing	Low pressure sensor	• Anomalous low pressure, broken wire of low pressure sensor or poor connector connection	Replacement, repair of sensor	112•113
							Outdoor unit control PCB	*• Defective outdoor unit control PCB (Defective sensor input circuit)?	Replacement of control PCB	
							Installation or operating condition	• Low pressure error • Service valve closing operation	Repair	
E51		Stays OFF	Keeps flashing	1-time flash	Keeps flashing	6-time flash	Inverter PCB	• Anomalous inverter PCB	Replacement of PCB	114
E53		Stays OFF	Keeps flashing	1-time flash	Keeps flashing		Suction pipe temperature sensor	• Defective suction pipe temperature sensor, broken wire or poor connector connection	Replacement, repair of temperature sensor	115
							Outdoor unit control PCB	*• Defective outdoor unit PCB (Defective sensor input circuit)?	Replacement of control PCB	
E54		Stays OFF	Keeps flashing	1-time flash	Keeps flashing	Keeps flashing	Low pressure sensor	• Defective low pressure sensor	Replacement of sensor	116
							Outdoor unit control PCB	• Defective outdoor unit control PCB (Defective sensor input circuit)?	Replacement of control PCB	
E57		Stays OFF	Keeps flashing	1-time flash	Keeps flashing		Operation status	• Shortage in refrigerant quantity	Repair	117
							Installation status	• Service valve closing operation	Service valve opening check	
E59		Stays OFF	Keeps flashing	5 time flash	Keeps flashing	Stays OFF	Compressor inverter PCB	• Anomalous compressor startup	Replacement	118•119

Note (1) * mark in the description of trouble means that, in ordinary diagnosis, it cannot identify the cause definitely, and, if the trouble is repaired by replacing the part, it is judged consequently that the replaced part was defective.

(iii) Option control in-use

Error code	Indoor unit control PCB		Outdoor unit control PCB		Description of trouble	Repair method	
	Red LED	Green LED	Red LED	Green LED			
E75	Keeps flashing	Stays OFF	Keeps flashing	Stays OFF	Keeps flashing	• Communication error (Defective communication circuit on the main unit of SC-SL2NA-E or SC-SL4-AE / BE) etc.	Replacement

(iv) Display sequence of error codes or inspection indicator lamps



■ Occurrence of one kind of error

Displays are shown respectively according to errors.

■ Occurrence of plural kinds of error

Section	Category of display
Error code on remote control	<ul style="list-style-type: none"> • Displays the error of higher priority (When plural errors are persisting) <p><i>E 1 > E 5 > > E 10 > E 32 > > E 60</i></p> <ul style="list-style-type: none"> • Displays the present errors. (When a new error has occurred after the former error was reset.)
Red LED on indoor unit control PCB	
Red LED on outdoor unit control PCB	

■ Error detecting timing

Section	Error description	Error code	Error detecting timing
Indoor	Drain trouble (Float switch activated)	<i>E 9</i>	Whenever float switch is activated after 30 seconds had past since power ON.
	Communication error at initial operation	“  WAIT  ”	No communication between indoor and outdoor units is established at initial operation.
	Remote control communication circuit error	<i>E 1</i>	Communication between indoor unit and remote control is interrupted for more than 2 minutes continuously after initial communication was established.
	Communication error during operation	<i>E 5</i>	Communication between indoor and outdoor units is interrupted for more than 2 minutes continuously after initial communication was established.
	Excessive number of connected indoor units by controlling with one remote control	<i>E 10</i>	Whenever excessively connected indoor units is detected after power ON.
	Return air temperature sensor anomaly	<i>E 7</i>	-50°C or lower is detected for 5 seconds continuously within 60 minutes after initial detection of this anomalous temperature.
	Indoor heat exchanger temperature sensor anomaly	<i>E 6</i>	-50°C or lower is detected for 5 seconds continuously within 60 minutes after initial detection of this anomalous temperature. Or 70°C or higher is detected for 5 seconds continuously
Outdoor	Outdoor air temperature sensor anomaly	<i>E 38</i>	-45°C or lower is detected for 5 seconds continuously 3 times within 40 minutes after initial detection of this anomalous temperature. Or -45°C or lower is detected for 5 seconds continuously within 20 seconds after compressor ON.
	Outdoor heat exchanger temperature sensor anomaly	<i>E 37</i>	-50°C or lower is detected for 5 seconds continuously 3 times within 40 minutes after initial detection of this anomalous temperature. Or -50°C or lower is detected for 5 seconds continuously within 20 seconds after compressor ON.
	Discharge pipe temperature sensor anomaly	<i>E 39</i>	-10°C or lower is detected for 5 seconds continuously 3 times within 40 minutes after initial detection of this anomalous temperature.
	Suction pipe temperature sensor anomaly	<i>E 53</i>	-50°C or lower is detected for 5 seconds continuously 3 times within 40 minutes after initial detection of this anomalous temperature.
	Low pressure sensor anomaly	<i>E 54</i>	0V or lower or 4.0V or higher is detected for 5 seconds continuously 3 times within 40 minutes after initial detection of this anomalous pressure.
	Compressor under dome temperature sensor anomaly	<i>E 55</i>	-50°C or lower is detected for 5 seconds continuously 3 times within 40 minutes after initial detection of this anomalous temperature.

■ **Error log and reset**

Error indicator	Memorized error log	Reset
Remote control display	• Higher priority error is memorized.	• Stop the unit by pressing the ON/OFF switch of remote control. • If the unit has recovered from anomaly, it can be operated.
Red LED on indoor unit control PCB	• Not memorized.	
Red LED on outdoor unit control PCB	• Memorizes a mode of higher priority.	

■ **Resetting the error log**

- Resetting the memorized error log in the remote control
Holding down “CHECK” button, press “TIMER” button to reset the error log memorized in the remote control.
- Resetting the memorized error log in the indoor unit
The remote control transmits error log erase command to the indoor unit when “VENTI” button is pressed while holding down “CHECK” button.
Receiving the command, the indoor unit erase the log and answer the status of no error.

(2) **Troubleshooting procedure**

When any trouble has occurred, inspect as follows. Details of respective inspection method will be described on later pages.

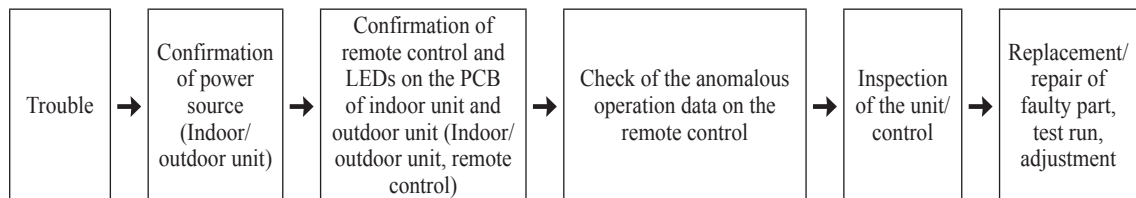

(3) **Troubleshooting at the indoor unit**

(a) **FDT, FDTC, FDU, FDUM, FDE series**

With the troubleshooting, find out any defective part by checking the voltage (AC, DC), resistance, etc. at respective connectors at around the indoor unit PCB, according to the inspection display or operation status of unit (the compressor does not run, fan does not run, the 4-way valve does not switch, etc.), and replace or repair in the unit of following part.

(i) **Replacement part related to indoor unit PCB's**

Control PCB, power source PCB, temperature sensor (return air, indoor heat exchanger), remote control switch, limit switch, transformer and fuse

Note (1) With regard to parts of high voltage circuits and refrigeration cycle, judge it according to ordinary inspection methods.

(ii) **Instruction of how to replace indoor unit control PCB**

SAFETY PRECAUTIONS

- Read the "SAFETY PRECAUTIONS" carefully first of all and then strictly follow it during the replacement in order to protect yourself.
- The precautionary items mentioned below are distinguished into two levels, WARNING and CAUTION. Both mentions the important items to protect your health and safety so strictly follow them by any means.

WARNING Wrong installation would cause serious consequences such as injuries or death.

CAUTION Wrong installation might cause serious consequences depending on circumstances.

- After completing the replacement, do commissioning to confirm there are no anomaly.

WARNING

- Replacement should be performed by the specialist.
If you replace the PCB by yourself, it may lead to serious trouble such as electric shock or fire.
- Replace the PCB correctly according to these instructions.
Improper replacement may cause electric shock or fire.
- Shut off the power before electrical wiring work.
Replacement during the applying the current would cause the electric shock, unit failure or improper running.
It would cause the damage of connected equipment such as fan motor, etc.
- Fasten the wiring to the terminal securely, and hold the cable securely so as not to apply unexpected stress on the terminal.
Loose connections or hold could result in abnormal heat generation or fire.
- Check the connection of wiring to PCB correctly before turning on the power, after replacement.
Defectiveness of replacement may cause electric shock or fire.

CAUTION

- In connecting connector onto the PCB, connect not to deform the PCB. It may cause breakage or malfunction.
- Insert connector securely, and hook stopper. It may cause fire or improper running.
- Bundle the cables together so as not to be pinched or be tensioned. It may cause malfunction or electric shock for disconnection or deformation.

1) Model FDT series

- a) Replace the control PCB
 - i) Unscrew terminal (Arrow A) of the "E1" wiring (yellow/green) that is connected to PCB.
 - ii) Replace the PCB only after all the wirings connected to the connector are removed.
 - iii) Fix the board such that it will not pinch any of the wires.
 - iv) Switch setting must be same setting as that of the removed PCB.
 - v) Reconnect the all wirings to the PCB, that was removed in ii).
 - vi) Rescrew the terminal (Arrow A) of the "E1" wiring, that was removed in i).

- b) Control PCB (※Parts mounting are different by the kind of PCB.)

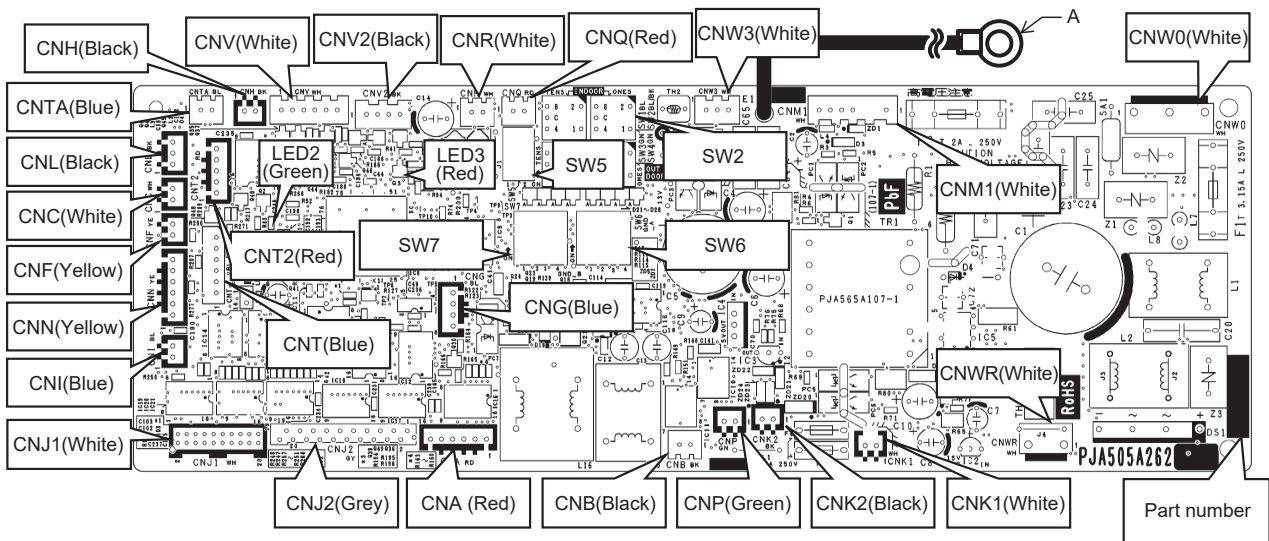

PSC012D050

2) Model FDTC series

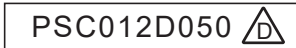

Replace and set up the PCB according to this instruction.

i) Set to an appropriate address and function using switch on PCB.

Select the same setting with the removed PCB.

Item	Switch	Content of control			
Address	SW2	Plural indoor units control by 1 remote control			
Master / Slave setting		Master	Slave 1	Slave 2	Slave 3
	SW5-1	—	—	○	○
	SW5-2	—	○	—	○
Test run	SW7-1	—	Normal		
		○	Operation check/drain pump motor test run		

○:ON —:OFF

ii) Set to an appropriate capacity using the model selector switch(SW6).

Select the same capacity with the PCB removed from the unit.

SW6	-1	-2	-3	-4
40VH	○	○	—	—

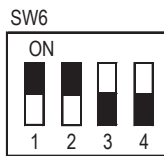

Example setting for 40VH

iii) Replace the PCB

- ① Unscrew terminal (Arrow A) of the "E1" wiring (yellow/green) that is connected to PCB.
- ② Replace the PCB only after all the wirings connected to the connector are removed.
- ③ Fix the board such that it will not pinch any of the wires.
- ④ Switch setting must be same setting as that of the removed PCB.
- ⑤ Reconnect the wirings to the PCB. Wiring connector color should match with the color of connector of the PCB.
- ⑥ Screw back the terminal(Arrow A) of the "E1" wiring, that was removed in ①.

iv) Control PCB

Parts mounting are different by the kind of PCB.

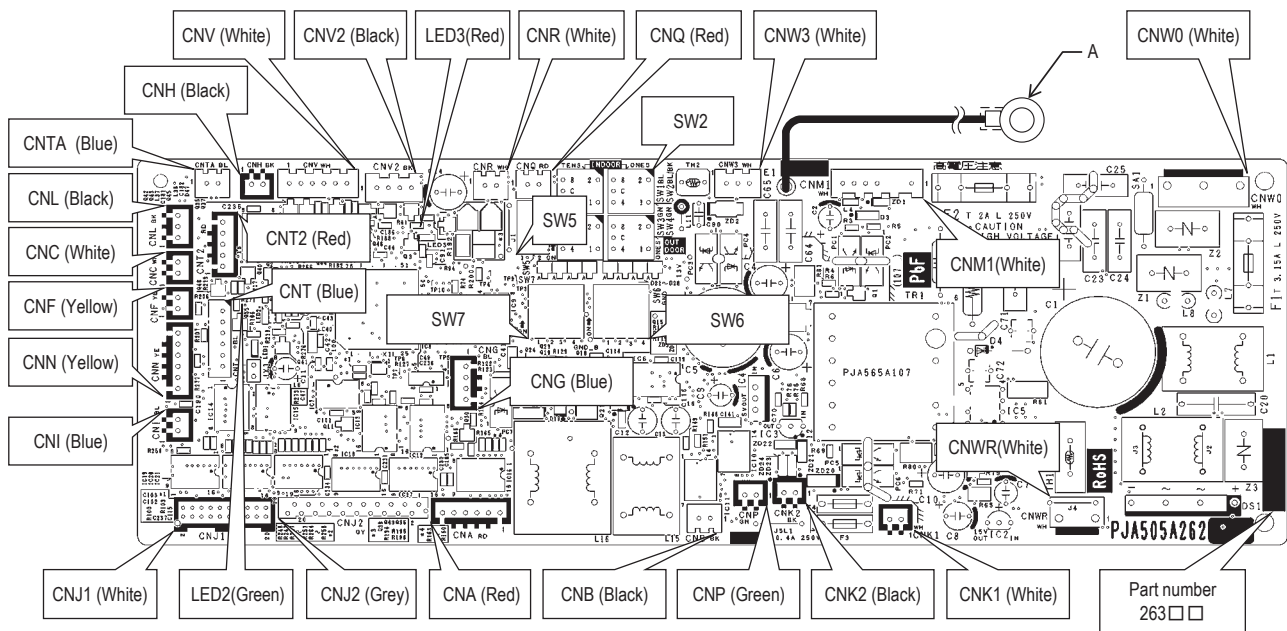

3) Models FDU, FDUM, FDE series

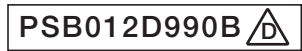

a) Control PCB

Replace and set up the PCB according to this instruction.

- i) Set to an appropriate address and function using switch on PCB.
Select the same setting with the removed PCB.

Item	Switch	Content of control			
Address	SW2	Plural indoor units control by 1 remote control			
Master /Slave setting	SW5-1	Master	Slave1	Slave2	Slave3
	SW5-2	—	—	○	○
Test run	SW7-1	—	Normal		
		○	Operation check/drain motor test run		

○:ON —:OFF

- ii) Set to an appropriate capacity using the model selector switch(SW6).

Select the same capacity with the PCB removed from the unit.

SW6	-1	-2	-3	-4
40VH	○	○	—	—
71VH	○	—	—	○

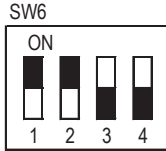

Example setting for 40VH

- iii) Replace the PCB

- ① Exchange PCB after detaching all connectors connected with the PCB.
- ② Fix the PCB so as not to pitch the wiring.
- ③ Connect connectors to the PCB. Match the wiring connector to the connector color on the PCB and connect it.

- iv) Control PCB

Parts mounting are different by the kind of PCB.

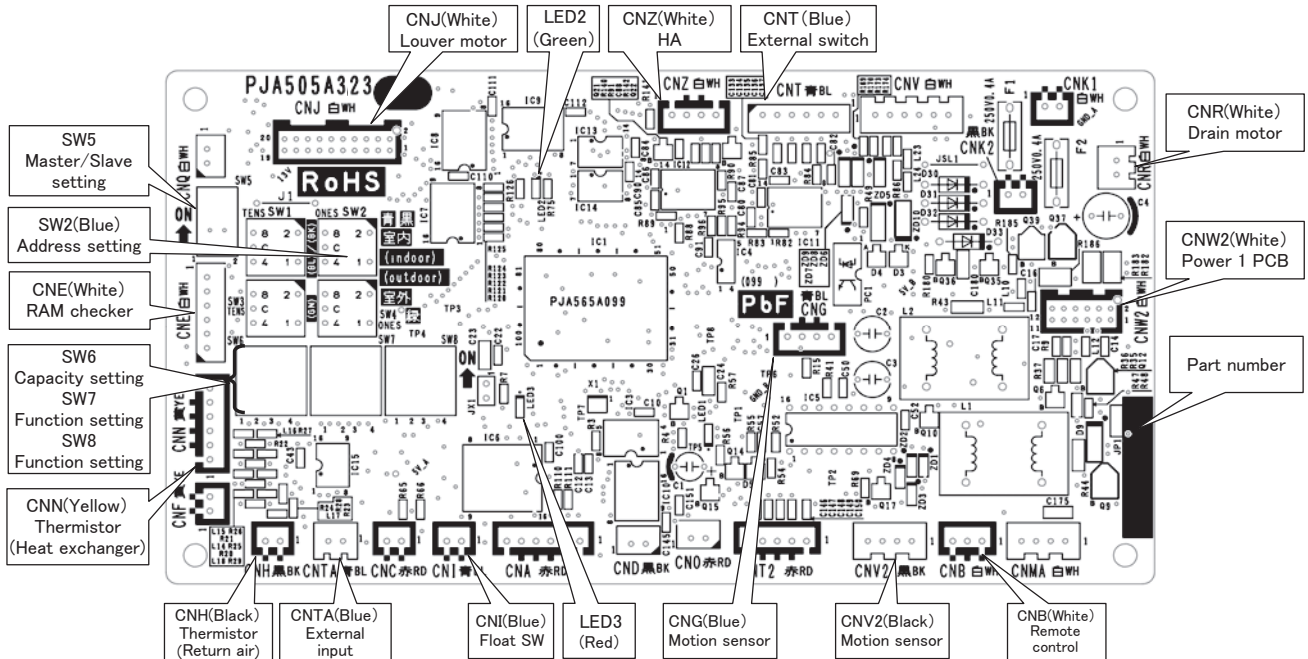

b) Power PCB

This PCB is a general PCB. Replace the PCB according to this instruction.

i) Replace the PCB

- ① Unscrew terminal of the wiring(yellow/green) connected to terminal block (CNWO) from the box.
- ② Replace the PCB only after all the wirings connected to the connector are removed.
- ③ Fix the board such that it will not pinch any of the wires.
- ④ Reconnect the wirings to the PCB. Wiring connector color should match with the color of connector of the PCB.
- ⑤ Screw back the terminal of wiring, that was removed in ①.

ii) Power PCB

Parts mounting are different by the kind of PCB.

• Model FDU71VH

PSC012D021 

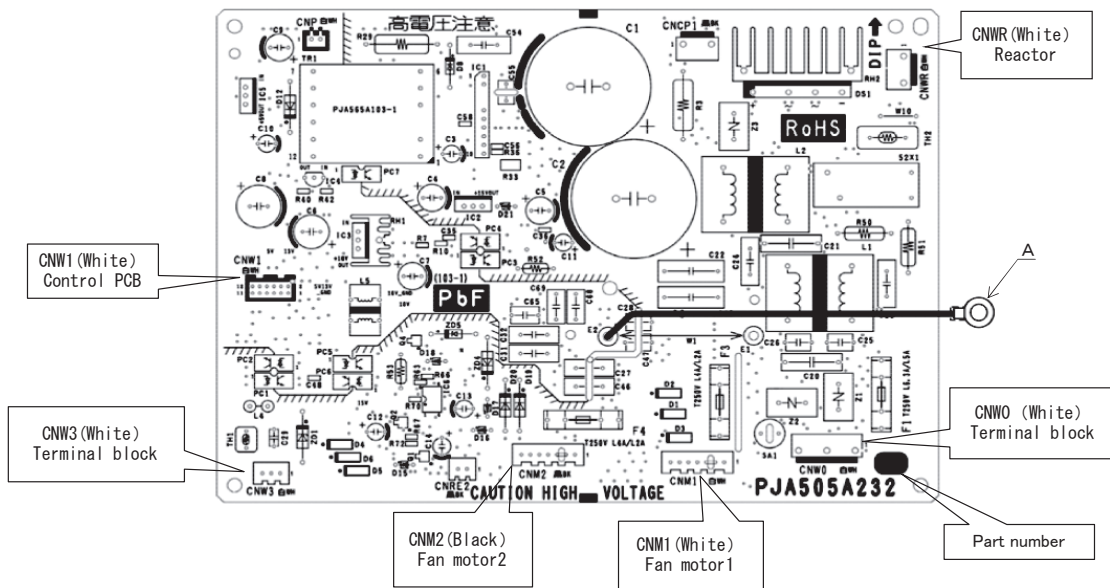

• Model FDUM71VH

PSB012D993

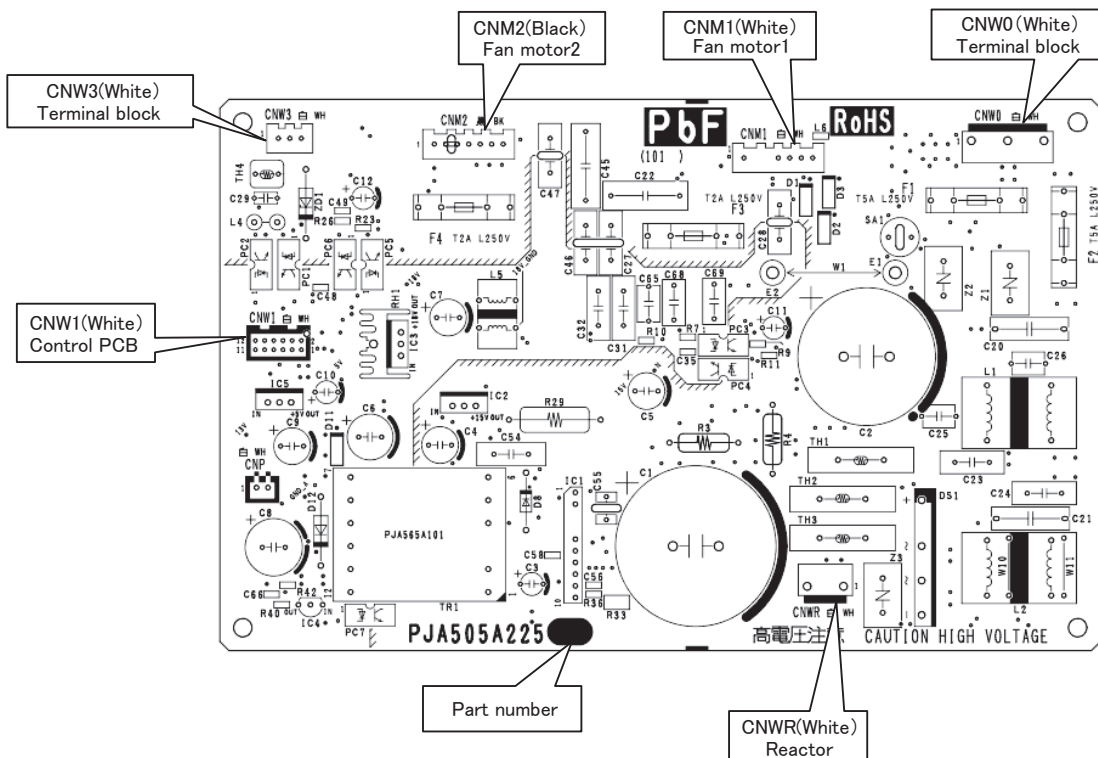

• Models FDE40, 71VH, FDUM40VH

PSB012D992 

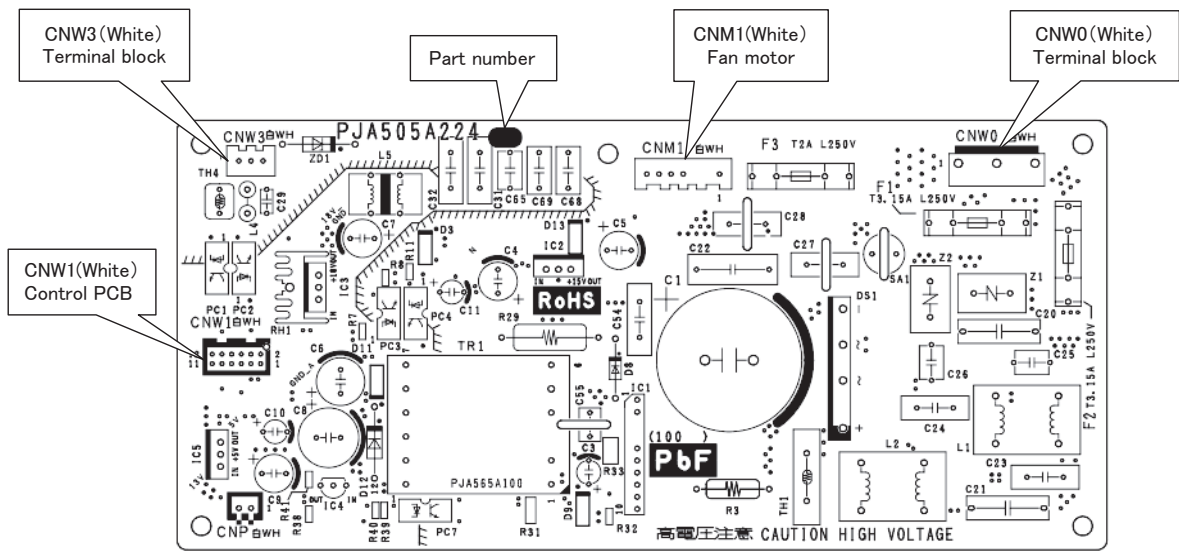

●DIP switch setting list

Switch	Description		Default setting		Remark
SW2	Address No. setting at plural indoor units control by 1 R/C		0		0-F
SW5-1	Master/Slave setting	Master*/Slave	OFF		See table 2.
SW5-2			OFF		
SW6-1	Model selection		As per model		See table 1.
SW6-2					
SW6-3					
SW6-4					
SW7-1	Test run, drain pump motor	Normal*/Test run	OFF	Normal	
SW7-2	Reserved		OFF		Keep OFF
SW7-3	Reserved		OFF		Keep OFF
SW7-4	Reserved		OFF		Keep OFF
SW8-1	Anti-freeze control	Valid/Invalid*	OFF	Invalid	
SW8-2	Reserved		OFF		Keep OFF
SW8-3	Reserved		OFF		Keep OFF
SW8-4	Reserved		OFF		Keep OFF
JSL1	Superlink terminal spare	Normal*/switch to spare	With		

Note(1) : SW8 : FDE only

* Default setting

Table 1: Indoor unit model selection with SW6-1-SW6-4

Switch	40VH	71VH
SW6-1	ON	ON
SW6-2	ON	OFF
SW6-3	OFF	OFF
SW6-4	OFF	ON

Table 2: Indoor unit Master/Slave setting with SW5-1,SW5-2

Switch	SW5-1	SW5-2
Master	OFF	OFF
Slave1	OFF	ON
Slave2	ON	OFF
Slave3	ON	ON

(4) Troubleshooting at the outdoor unit

When troubleshooting the outdoor unit, firstly assess the overview of malfunction and try to presume the cause and the faulty part by checking the error code displayed on the remote control and flashing pattern of indicator lamps (Red LED and Green LED), and then proceed further inspection and remedy it.

Self-diagnosis system by microcomputer on indoor unit and outdoor unit PCB can assist to find the cause of malfunction smoothly by making a diagnosis of not only the anomaly of microcomputer, but also the anomaly in power source system, installation space, overload resulting from improper charging amount of refrigerant and etc.

Unless the power is reset, the error log is saved in memory and the inspection indicator lamps on outdoor unit PCB keep flashing after automatical recovering from malfunction.

After automatical recovering from malfunction, if any another error mode which has a higher priority than the previous error saved in memory occurs, it is overwritten in memory and is displayed.

[Reset of power source]

Be sure to avoid electrical shock, when replacing or checking the outdoor unit control PCB, because some voltage is still retained in the electrolytic capacitor on the PCB even after shutting down the power source to the outdoor unit.

Be sure to start repairing work, after confirming that the red LED or green LED on the PCB has been extinguished for more than 10 seconds after more than 3 minutes had been passed since power shut down, and reconfirming that voltage has been discharged sufficiently by measuring the voltage (DC) between both terminals of electrolytic capacitor (C58) (Measurement of voltage may be disturbed by the moisture-proof coating. In such case, remove the coating and measure it by taking care of avoiding electrical shock.)

(a) Module of part to be replaced for outdoor unit control

Outdoor unit control PCB, Inverter PCB, Temperature sensor (of outdoor heat exchanger, discharge pipe, outdoor air, IPM, suction pipe and under dome), Fuses (for power source and control PCB), Noise filter, Capacitor and Reactor.

(b) Replacement procedure of outdoor unit control PCB

Precautions for Safety	
<ul style="list-style-type: none"> • Since the following precaution is the important contents for safety, be sure to observe them. WARNING and CAUTION are described as follows: 	
<div style="border: 1px solid black; padding: 2px; display: inline-block;"> WARNING</div>	Indicates an imminently hazardous situation which will result in death or serious injury if proper safety procedures and instructions are not adhered to.
<div style="border: 1px solid black; padding: 2px; display: inline-block;"> CAUTION</div>	Indicates a potentially hazardous situation which may result in minor or moderate injury if proper safety procedures and instructions are not adhered to.
WARNING	
<ul style="list-style-type: none"> • Securely replace the PCB according to this procedure. If the PCB is incorrectly replaced, it will cause an electric shock or fire. • Be sure to check that the power source for the outdoor unit is turned OFF before replacing the PCB. The PCB replacement under current-carrying will cause an electric shock or fire. • After finishing the PCB replacement, check that wiring is correctly connected with the PCB before power distribution. If the PCB is incorrectly replaced, it will cause an electric shock or fire. 	
CAUTION	
<ul style="list-style-type: none"> • Band the wiring so as not to tense because it will cause an electric shock. 	

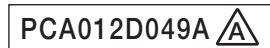

Model FDC71VNX-W

- 1) Replace the PCB **after elapsing 3 minutes from power OFF.**
(Be sure to measure voltage (DC) between T26 and T27 on inverter PCB, and check that the voltage is discharged sufficiently(10V or less).(Refer to Fig.2))
- 2) Disconnect the connectors from the control PCB.
- 3) Match the switches setting (SW4) with the former PCB.
- 4) Connect the connectors to the control PCB.(Confirm the **connectors are not half inserted.**)

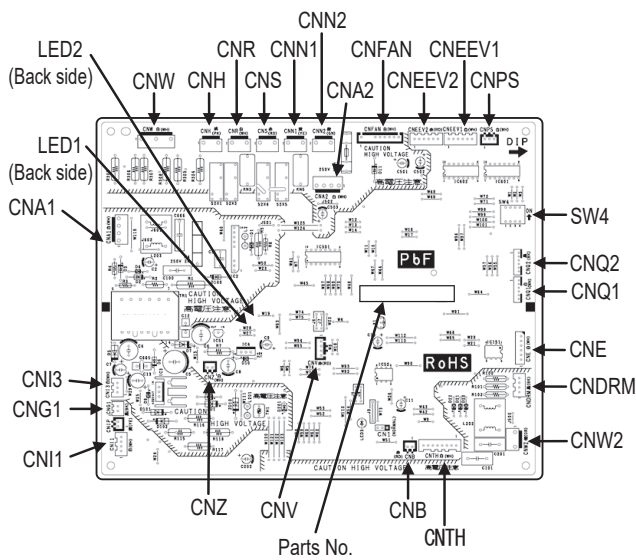

Fig.1 Parts arrangement view

After elapsing 3 minutes from power OFF

Voltage measurement point (T26 (red), T27 (blue))

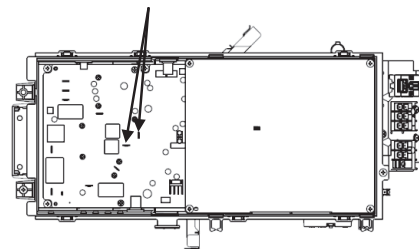

Fig.2 Position of terminal

*Presence and shape of electric component may vary according to model.

Connectors are not half inserted

(c) Outdoor inverter PCB replacement procedure

Precautions for Safety

- Since the following precaution is the important contents for safety, be sure to observe them.
WARNING and CAUTION are described as follows:

WARNING	Indicates an imminently hazardous situation which will result in death or serious injury if proper safety procedures and instructions are not adhered to.
CAUTION	Indicates a potentially hazardous situation which may result in minor or moderate injury if proper safety procedures and instructions are not adhered to.

WARNING

- Securely replace the PCB according to this procedure.
If the PCB is incorrectly replaced, it will cause an electric shock or fire.
- Be sure to check that the power source for the outdoor unit is turned OFF before replacing the PCB. The PCB replacement under current-carrying will cause an electric shock or fire.
- After finishing the PCB replacement, check that wiring is correctly connected with the PCB before power distribution. If the PCB is incorrectly replaced, it will cause an electric shock or fire.

CAUTION

- Band the wiring so as not to tense because it will cause an electric shock.

Replace the inverter PCB according to the following procedure.

Model FDC71VNX-W

PCA012D067B

- 1) Replace the PCB **after elapsing 3 minutes from power OFF.**
(High voltage is retained on the capacitor after turning the power off. It is very dangerous to touch the PCB in this condition.)
In the situation that harnesses are connected to inverter PCB **be sure to measure voltage (DC)** between T26 and T27 on inverter PCB, and **check that the voltage is discharged sufficiently.** (Refer to Fig.2).
- 2) Disconnect the connectors and faston terminals from the inverter PCB as shown in Fig. 1.
- 3) Match the setting of switches (JSW10, 11) of new PCB with former PCB.
- 4) Remove the harness bands (3 places) from the control unit, then remove the fixing screws (4places) from the radiator. (Refer to Fig.3)
- 5) Remove the inverter PCB with radiator from the control unit, and exchange the inverter PCB with radiator. Be careful not to pinch the wiring at the time of exchanging.
- 6) Fix the radiator to the control unit by screws. After exchanging the inverter PCB, reconnect the connectors, faston terminals and the harnesses as before. (Confirm that the **connectors are not half inserted.**)
- 7) Attach the harness bands (3 places), then reconnect the harnesses as before.
- 8) Install the harness clip on the inverter PCB as shown in Fig.4, and fix the harness.

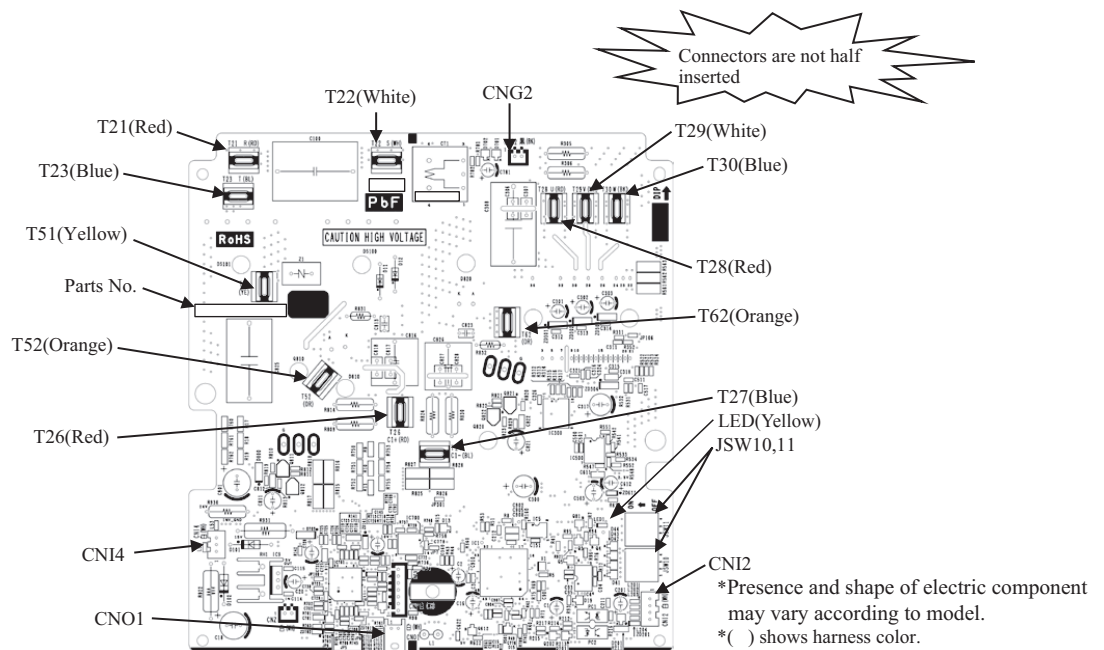

Fig.1Parts arrangement view of inverter PCB

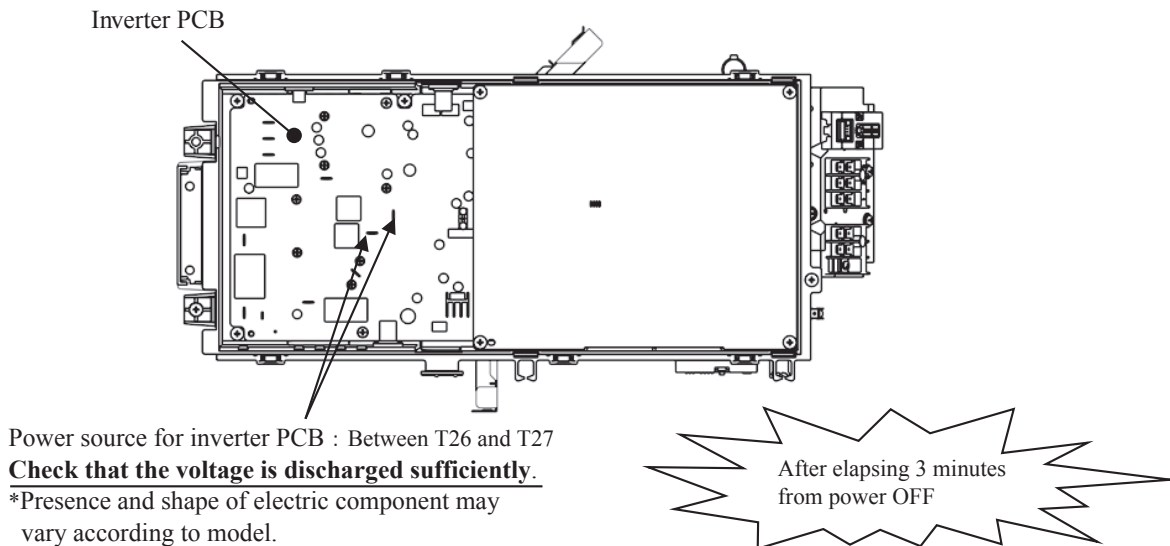

Fig.2 Voltage measurement points

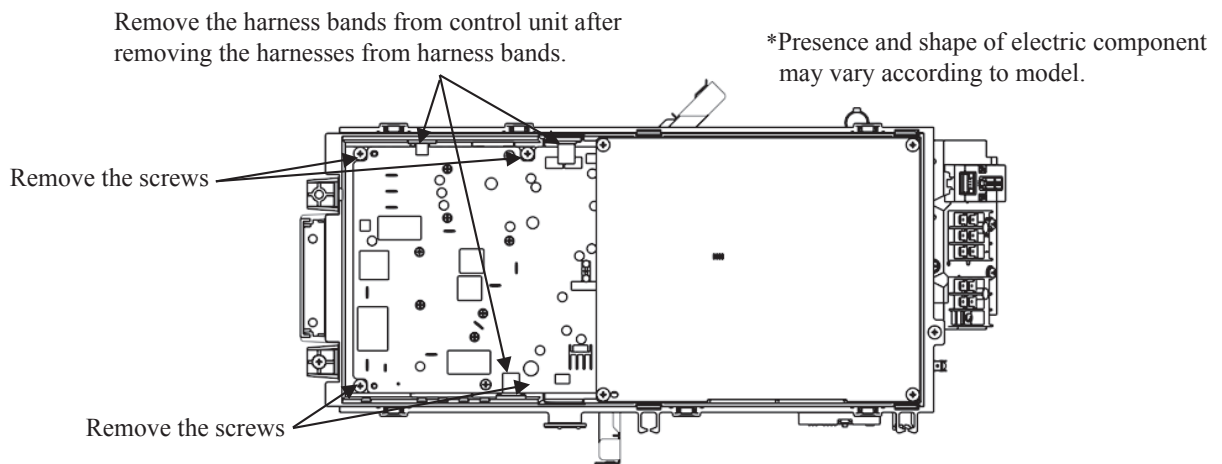

Fig.3 Target places where harness bands and screws are removed

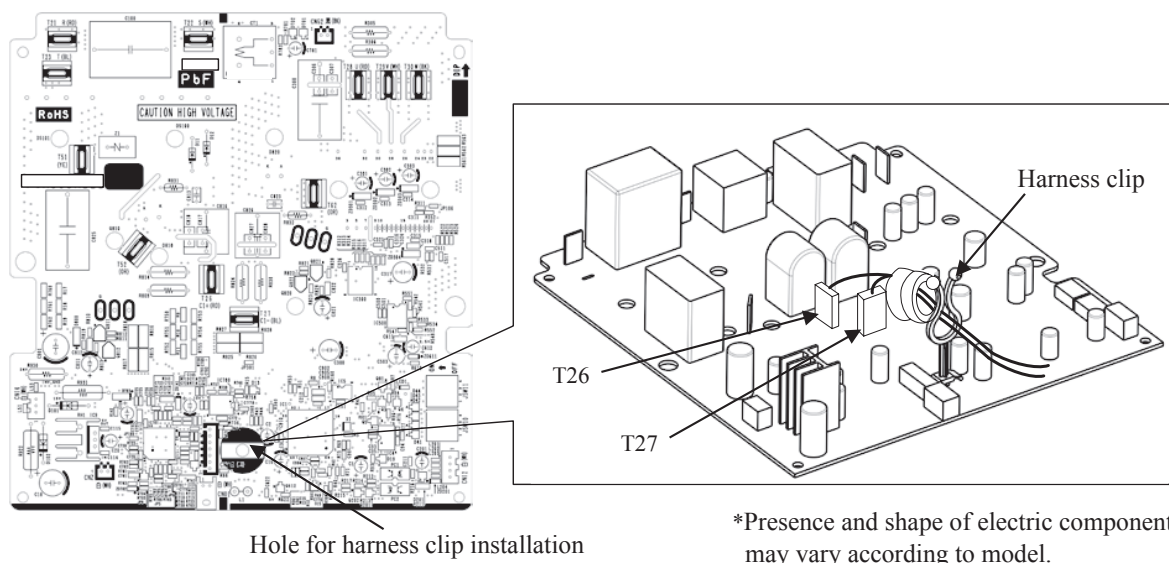

Fig.4 Fix the harness on the harness clip

● DIP switch setting list (Outdoor unit)

Model FDC71VNX-W

(1) Control PCB

Switch	Description		Default setting		Remark
SW3-1	Defrost condition	Normal*/Cold region	OFF	Normal	
SW3-2	Snow protection control	Normal*/Snow protection	OFF	Normal	
SW3-3	Model selection	Cooling only/Heat pump*	OFF	Heat pump	Keep OFF
SW3-4	Defrost prohibition time	ON: 37min*/OFF: 45min	ON	37min.	
SW4-1	Model selection	Domestic/Overseas*	ON	Overseas	Keep ON
SW4-2	Model selection	3 phase/Single phase*	ON	Single phase	Keep ON
SW4-3	Reserved		OFF		Keep OFF
SW4-4	Reserved		OFF		Keep OFF
SW5-1	Model selection		OFF		Keep OFF
SW5-2	Model selection		OFF		Keep OFF
SW5-3	Test run Switch	Normal*/Test run	OFF	Normal	
SW5-4	Test run mode	Cooling*/Heating	OFF	Cooling	
SW7-1	Reserved		OFF		Keep OFF
SW7-2	Reserved		OFF		Keep OFF
SW7-3	Reserved		OFF		Keep OFF
SW8-1	Reserved		OFF		Keep OFF
SW8-2	Reserved		OFF		Keep OFF
SW8-3	Reserved		OFF		Keep OFF
SW9	Pump down operation	Normal*/Pump down	OFF	Normal	

* Default setting

(2) Inverter PCB

Switch	FDC71VNX-W
	Single phase models
JSW10-1	OFF
JSW10-2	OFF
JSW10-3	OFF
JSW10-4	OFF *
JSW11-1	ON
JSW11-2	ON
JSW11-3	ON
JSW11-4	ON

* When checking inverter PCB of FDC71 model with inverter checker, turn JSW10-4 ON.

(Regarding the checking method of inverter PCB with inverter checker, refer to page 62 for details)

(5) Check of anomalous operation data with the remote control

(a) In case of RC-EX3A remote control

[Operating procedure]

① On the TOP screen, touch the buttons in the order of “Menu” → “Service setting” → “Service & Maintenance” → “Service password” → “Set” → “Error display” → “Error history”.

② When only one indoor unit is connected to the remote control, followings will be displayed.

1. When there is any anomaly: “Loading. Wait a while” is displayed, followed by the operation data at the occurrence of anomaly

Contents of display

- Error code
- Number and data item

2. When there is no anomaly: “No anomaly” is displayed, and this mode is terminated.

③ When two or more indoor units are connected to the remote control, followings will be displayed.

1. When there is any anomaly: If the unit having anomaly is selected on the “Select IU” screen, “Loading. Wait a while” is displayed, followed by the operation data at the occurrence of anomaly.

Contents of display

- Indoor unit No.
- Error code
- Number and data item

2. When there is no anomaly: “No anomaly” is displayed, and this mode is terminated.

Note (1) When the number of connected units cannot be shown in a page, select “Next”.

④ If you press [RUN/STOP] button, the display returns to the TOP screen.

◎ **If you touch “Back” button on the way of setting, the display returns to the last precious screen.**

Note (1) When two remote controls are used to control indoor units, the check of anomaly operation data can be made on the master remote control only. (It cannot be operated from the slave remote control.)

■ Anomaly operation data (Corresponding data may not be provided depending on models. Such items will not be displayed.)

Number	Data Item
01	非 (Operation Mode)
02	SET TEMP (Set Temperature)
03	RETURN AIR (Return Air Temperature)
04	SENSOR (Remote Control Temperature Sensor)
05	THI-R1 (Indoor Heat Exchanger Temperature Sensor / U Bend)
06	THI-R2 (Indoor Heat Exchanger Temperature Sensor / Capillary)
07	THI-R3 (Indoor Heat Exchanger Temperature Sensor / Gas Header)
08	I/U FANSPEED (Indoor Unit Fan Speed)
09	DEMAND Hz (Frequency Requirements)
10	ANSWER Hz (Response Frequency)
11	I/U EEV P (Pulse of Indoor Unit Expansion Valve)
12	TOTAL I/U RUN H (Total Running Hours of The Indoor Unit)
13	SUPPLY AIR (Supply Air Temperature)
21	OUTDOOR (Outdoor Air Temperature)
22	THO-R1 (Outdoor Heat Exchanger Temperature Sensor)
23	THO-R2 (Outdoor Heat Exchanger Temperature Sensor)
24	COMP Hz (Compressor Frequency)
25	HP MPa (High Pressure)
26	LP MPa (Low Pressure)
27	Td (Discharge Pipe Temperature)
28	COMP BOTTOM (Comp Bottom Temperature)
29	CT AMP (Current)
30	TARGET SH (Target Super Heat)
31	SH (Super Heat)
32	TDSH (Discharge Pipe Super Heat)
33	PROTECTION No. (Protection State No. of The Compressor)
34	O/U FANSPEED (Outdoor Unit Fan Speed)
35	ESH1 (63H1 On/Off)
36	DEFROST (Defrost Control On/Off)
37	TOTAL COMP RUN H (Total Running Hours of The Compressor)
38	O/U EEV1 P (Pulse of The Outdoor Unit Expansion Valve EEVC)
39	O/U EEV2 P (Pulse of The Outdoor Unit Expansion Valve EEVH)

●Number 33 Details of compressor protection status No. Model FDC71VNX-W

No.	Contents of display	Reference page
"0"	Normal	
"1"	Discharge pipe temperature protection control	P.45, (6).(a).(i)
"2"	Discharge pipe temperature anomaly	P.45, (6).(a).(ii)
"3"	Current safe control of inverter primary current	P.47, (6).(f)
"4"	High pressure protection control	P.45, (6).(b).(i), P.46, (6).(c).(i)
"5"	High pressure anomaly	P.45, (6).(b).(ii)
"6"	Low pressure protection control	P.46, (6).(c).(i)
"7"	Low pressure anomaly	P.46, (6).(c).(ii)
"8"	Anti-frost prevention control	P.47, (6).(h)
"9"	Current cut	P.47, (6).(f)
"11"	Power transistor anomaly (Overheat)	P.47, (6).(g)
"13"	Spare	
"15"	Current safe control of inverter secondary current	P.47, (6).(f)
"16"	Stop by compressor rotor lock	
"17"	Stop by compressor startup failure	P.48, (6).(t)
"18"	Active filter anomaly	

Note(1) Operation data display on the remote control.

- Data is displayed until canceling the protection control.
- In case of multiple protections controlled, only the younger No. is displayed.

Note(2) Common item.

- ① In heating mode.
During protection control by the command signal for reducing compressor frequency from indoor unit, No. "4" is displayed.
- ② In cooling and dehumidifying mode.
During protection control by the command signal for reducing compressor frequency from indoor unit, No. "8" is displayed.

(b) In case of RC-E5 remote control

Operation data can be checked with remote control unit operation.

- ① Press the **CHECK** button.
The display change “ OPER DATA ▼ ”
- ② Press the **(SET)** button while “ OPER DATA ▼ ” is displayed.

- ③ When only one indoor unit is connected to remote control, “ DATA LOADING ” is displayed (blinking indication during data loading).

Next, operation data of the indoor unit will be displayed.
Skip to step ⑦.

- ④ When plural indoor units is connected, the smallest address number of indoor unit among all connected indoor unit is displayed.

[Example]:

“ SELECT I/U ” (blinking 1 seconds) → “ I/U000 ▲ ” blinking.

- ⑤ Select the indoor unit number you would like to have data displayed with the **▲ ▼** button.

- ⑥ Determine the indoor unit number with the **(SET)** button.

(The indoor unit number changes from blinking indication to continuous indication)

“ I/U000 ” (The address of selected indoor unit is blinking for 2 seconds.)



“ DATA LOADING ” (A blinking indication appears while data loaded.)

Next, the operation data of the indoor unit is indicated.

- ⑦ Upon operation of the **▲ ▼** button, the current operation data is displayed in order from data number 01. The items displayed are in the above table.

*Depending on models, the items that do not have corresponding data are not displayed.

- ⑧ To display the data of a different indoor unit, press the **AIR CON No.** button, which allows you to go back to the indoor unit selection screen.

- ⑨ Pressing the **ON/OFF** button will stop displaying data.

Pressing the **(RESET)** button during remote control unit operation will undo your last operation and allow you to go back to the previous screen.

- If two (2) remote controls are connected to one (1) inside unit, only the master control is available for trial operation and confirmation of operation data. (The slave remote control is not available.)

● Number 33 Details of compressor protection status

Refer to page 65.

Number	Data Item
01	(Operation Mode)
02	SET TEMP (Set Temperature)
03	RETURN AIR (Return Air Temperature)
04	SENSOR (Remote Control Temperature Sensor)
05	THI-R1 (Indoor Heat Exchanger Temperature Sensor / U Bend)
06	THI-R2 (Indoor Heat Exchanger Temperature Sensor /Capillary)
07	THI-R3 (Indoor Heat Exchanger Temperature Sensor /Gas Header)
08	I/U FANSPEED (Indoor Unit Fan Speed)
09	DEMAND Hz (Frequency Requirements)
10	ANSWER Hz (Response Frequency)
11	I/U EEV P (Pulse of Indoor Unit Expansion Valve)
12	TOTAL I/U RUN H (Total Running Hours of The Indoor Unit)
21	OUTDOOR (Outdoor Air Temperature)
22	THO-R1 (Outdoor Heat Exchanger Temperature Sensor)
23	THO-R2 (Outdoor Heat Exchanger Temperature Sensor)
24	COMP Hz (Compressor Frequency)
25	HP MPa (High Pressure)
26	LP MPa (Low Pressure)
27	Td (Discharge Pipe Temperature)
28	COMP BOTTOM (Compressor Bottom Temperature)
29	CT AMP (Current)
30	TARGET SH (Target Super Heat)
31	SH (Super Heat)
32	TDSH (Discharge Pipe Super Heat)
33	PROTECTION No. (Protection State No. of The Compressor)
34	O/U FANSPEED (Outdoor Unit Fan Speed)
35	63H1 (63H1 On/Off)
36	DEFROST (Defrost Control On/Off)
37	TOTAL COMP RUN H (Total Running Hours of The Compressor)
38	O/U EEV1 P (Pulse of The Outdoor Unit Expansion Valve EEVC)
39	O/U EEV2 P (Pulse of The Outdoor Unit Expansion Valve EEVH)

(6) Power transistor module (Including the driver PCB) inspection procedure

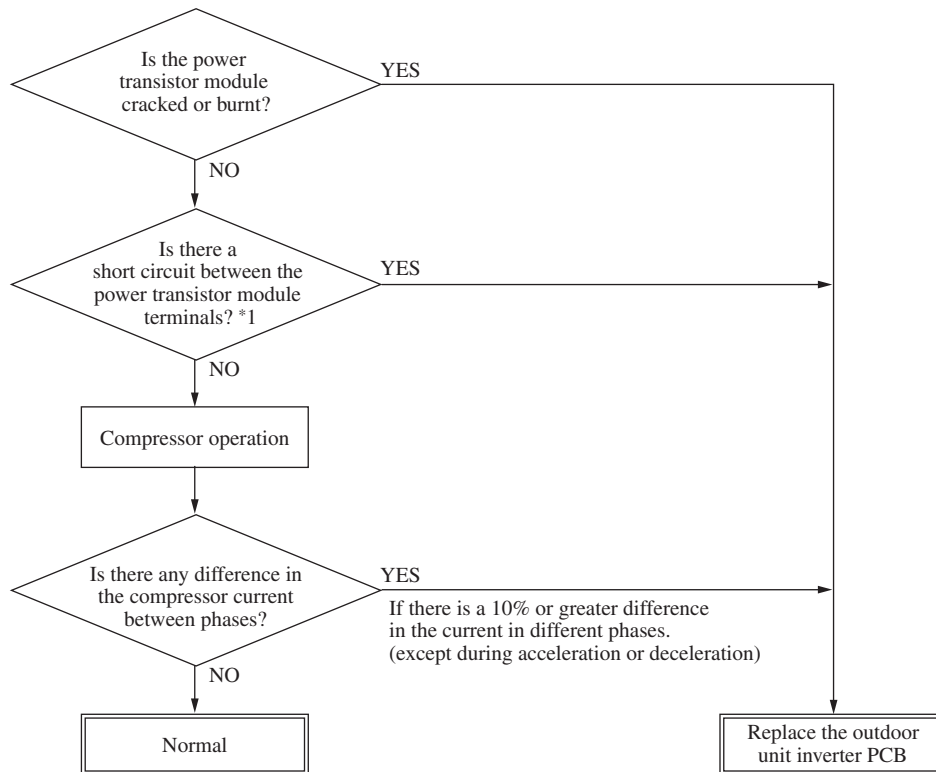

***1 Power transistor module terminal short circuit check procedure**

Disconnect the compressor wiring, then conduct a short circuit check.

P-U, P-V, P-W

N-U, N-V, N-W

Check between the P-N terminals.

Bring the tester probes in contact with the following places on each terminal.

P: Power transistor P terminal,

N: Power transistor N terminal,

U: End of red harness to compressor

V: End of white harness to compressor

W: End of black or blue harness to compressor

Check for a power transistor short-circuit.

- When you do not have a diagnostic checker for judging if the inverter is defective, measure between the terminals of the power transistor parts, judge whether the power transistor is defective or not.
- Disconnect the compressor, then measure with the control incorporated.

Model FDC71VNX-W

Tester		Normal value (Ω)
Terminal (+)	Terminal (-)	Model FDC71
P	N	0 - (Numerical value rises.)
N	P	
P	U	Several M (Numerical value rises.)
P	V	
P	W	
N	U	Approx. 650 k
N	V	
N	W	
U	P	Approx. 670 k
V	P	Approx. 4.4 M
W	P	Approx. 4.4 M
U	N	Approx. 650 k
V	N	Approx. 4.8 M
W	N	Approx. 4.9 M

If the measured values range from 0 - several kW, there is a possibility that the elements are damaged, so replace the power transistor parts.

**(7) Inverter checker for diagnosis of inverter output
Model FDC71VNX-W**

Model FDC71VNX-W

(i) Setup procedure of checker.

- 1) Power OFF (Turn off the breaker).
- 2) Remove the terminal cover of compressor and disconnect the wires (U, V, W) from compressor.
- 3) Connect the wires U (Red) , V (White) and W (Black) of checker to the terminal of disconnected wires (U, V, W) from compressor respectively.

(ii) Operation for judgment.

- 1) Power ON after JSW10-4 on outdoor inverter PCB was turned ON.
- 2) After 15 seconds since power has turned ON, LED start ON/OFF for 5 seconds cyclically and it repeats 10 times.
- 3) Check ON/OFF status of 6 LED's on the checker.
- 4) Judge the PCB by ON/OFF status of 6 LED's on the checker.

ON/OFF status of LED	If all of LED are ON/OFF according to following pattern	If all of LED stay OFF or some of LED are ON/OFF
Inverter PCB	Normal	Anomalous

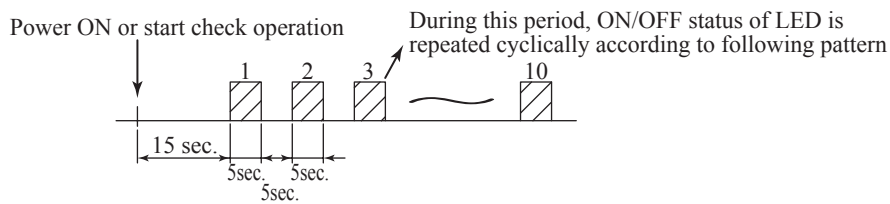

- 5) Be sure to turn off JSW10-4 on outdoor inverter PCB, after finishing the check operation.

<Inverter checker>

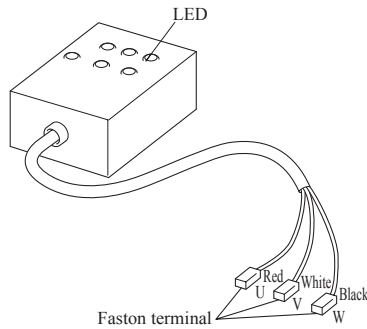

LED ON/OFF pattern

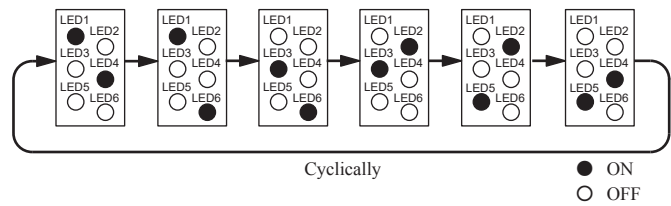

Connect to the terminal of the wires which are disconnected from compressor.

(8) Outdoor unit control failure diagnosis circuit diagram
 Model FDC71VNX-W

• Outdoor unit check points

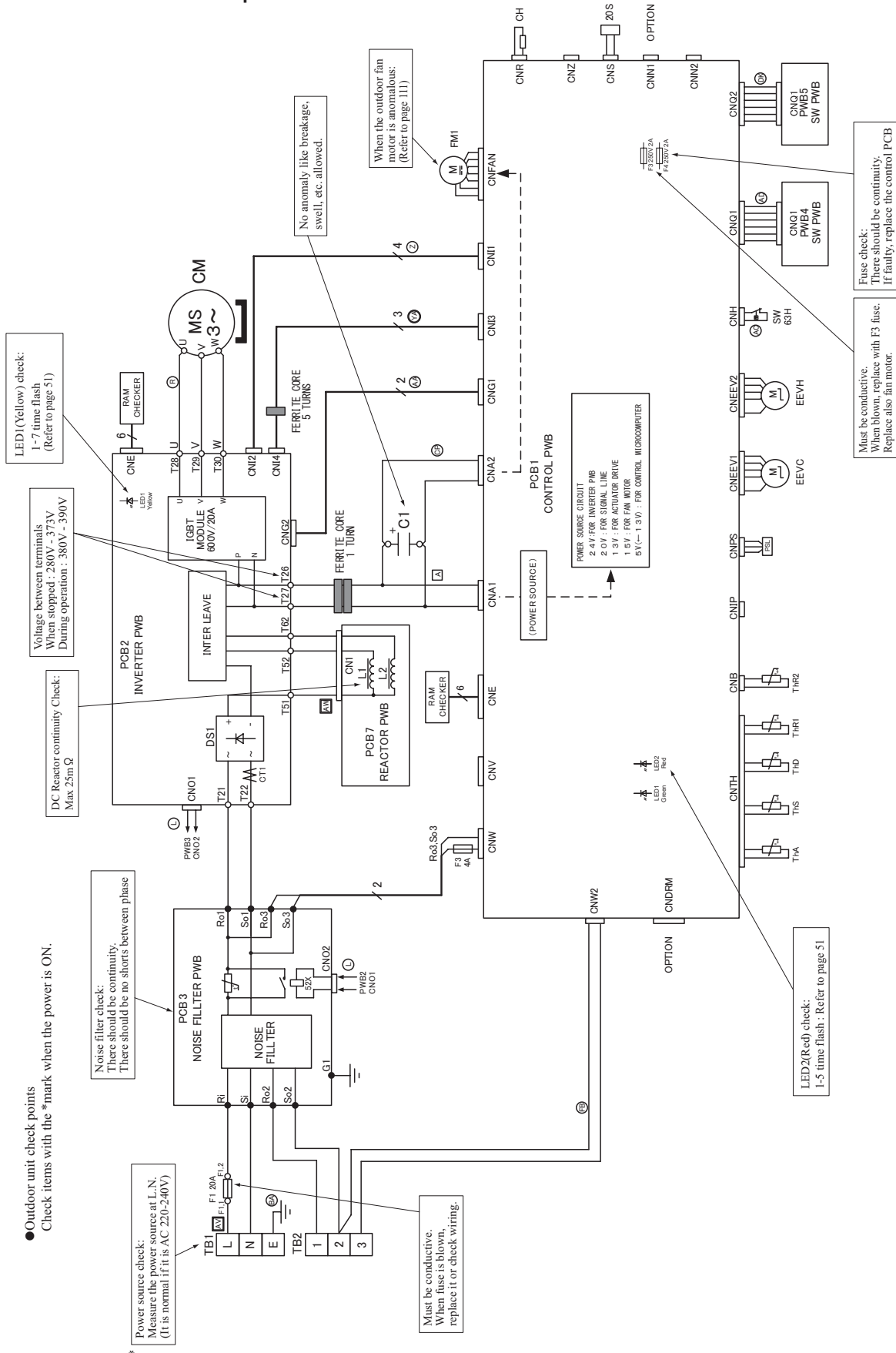



• Outdoor unit check points
 Check items with the *mark when the power is ON.

1.2.1.2 Troubleshooting flow

(1) List of troubles

Model FDC71VNX-W

Remote control display	Description of trouble	Reference page
None	Operates but does not cool	71
None	Operates but does not heat	72
None	Earth leakage breaker activated	73
None	Excessive noise/vibration (1/3)	74
None	Excessive noise/vibration (2/3)	75
None	Excessive noise/vibration (3/3)	76
None	Louver motor failure	77
None	Power source system error (Power source to indoor unit control PCB)	78
None	Power source system error (Power source to remote control)	79
INSPECT I/U	INSPECT I/U (When 1 or 2 remote controls are connected)	80
INSPECT I/U	INSPECT I/U (Connection of 3 units or more remote controls)	81
 WAIT 	Communication error at initial operation	82-84
None	No display	85
E1	Remote control communication circuit error	86
E5	Communication error during operation	87
E6	Indoor heat exchanger temperature sensor anomaly	88
E7	Return air temperature sensor anomaly	89
E8	Heating overload operation	90
E9	Drain trouble	91
E10	Excessive number of connected indoor units (more than 17 units) by controlling with one remote control	92
E11	Address setting error of indoor units	93
E14	Communication error between master and slave indoor units	94
E16	Indoor fan motor anomaly	95
E18	Address setting error of master and slave indoor units	96
E19	Indoor unit operation check, drain pump motor check setting error	97
E20	Indoor fan motor rotation speed anomaly	98
E28	Remote control temperature sensor anomaly	99
E35	Cooling overload operation	100
E36	Discharge pipe temperature error	101
E37	Outdoor heat exchanger temperature sensor anomaly	102
E38	Outdoor air temperature sensor anomaly	103
E39	Discharge pipe temperature sensor anomaly	104
E40	High pressure error (63H1 activated)	105
E41	Power transistor overheat	106
E42	Current cut	107 · 108
E45	Communication error between inverter PCB and outdoor unit control PCB	109
E47	Inverter PCB A/F module anomaly	110
E48	Outdoor fan motor anomaly	111
E49	Low pressure error or low pressure sensor anomaly	112 · 113
E51	Inverter and fan motor anomaly	114
E53	Suction pipe temperature sensor anomaly	115
E54	Low pressure sensor anomaly	116
E57	Insufficient refrigerant amount or detection of service valve closure	117
E59	Compressor startup failure	118 · 119

(2) Troubleshooting

Error code Remote control: None	LED	Green	Red	Content Operates but does not cool
	Indoor	Keeps flashing	Stays OFF	
	Outdoor	Keeps flashing	Stays OFF	

1. Applicable model
2. Error detection method
3. Condition of error displayed
4. Presumable cause
<ul style="list-style-type: none"> • Poor compression of compressor • Faulty expansion valve operation

5. Troubleshooting	
Diagnosis	Countermeasure
<p>Check the indoor fan operation. Check the temperature difference between return and supply air.</p> <pre> graph TD Start[Check indoor fan operation and temperature difference] --> D1{Is the temperature difference between return and supply air 10-20°C at cooling?} D1 -- YES --> D2{Does the heat load increase after installation?} D1 -- NO --> D3{Is the compressor operating?} D2 -- YES --> Box1[Mistake in model selection. Calculate heat load once more.] D2 -- NO --> CM1[It is normal. (This unit is designed to start in the soft start mode by detecting the under dome temperature of compressor when it restart after power reset.)] D3 -- NO --> D4{"⌚ WAIT ⌚" message is displayed (for 3 seconds) when performing cooling, defrost and heating operations from the remote control.} D3 -- YES --> D5{Is the compressor rotation speed low?} D4 -- YES --> CM2[It is necessary to replace to higher capacity one or two install additional unit.] D4 -- NO --> CM3[Compressor may be stopped by the error detection control. For the contents of control, refer to anomalous stop control by controlling compressor rotation speed of microcomputer control functions.] D5 -- NO --> CM4[Inspect the followings. • Minor clogging of filter • Minor clogging of heat exchanger • Minor short-circuit • Minor shortage of refrigerant amount • Poor compression of compressor] D5 -- YES --> Box2[Check which control "Determination control of compressor rotation speed" or "Protective control by controlling compressor rotation speed" is appropriate to this phenomenon.] Box2 --> D6{Are the temperature conditions of room and outdoor air close to the rated conditions? (1)} D6 -- YES --> CM5[Considering appropriate operation control, check suspicious points. Inspect the followings for reference. • Major clogging of filter • Major clogging of heat exchanger • Major short-circuit • Major shortage of refrigerant amount • Compressor protection ON • Indoor fan tap • Valid setting of silent mode] D6 -- NO --> End[The unit is operating normally but is operating under the control for protecting compressor or other respective parts.] </pre>	

Note:

Error code Remote control: None	LED	Green	Red	Content Operates but does not heat
	Indoor	Keeps flashing	Stays OFF	
	Outdoor	Keeps flashing	Stays OFF	

1. Applicable model
2. Error detection method
3. Condition of error displayed
4. Presumable cause

- Faulty 4-way valve operation
- Poor compression of compressor
- Faulty expansion valve operation

5. Troubleshooting	
Diagnosis	Countermeasure
<p>Check the indoor fan operation. Check the temperature difference between return and supply air.</p> <p>Is the temperature difference between return and supply air 10-30°C at heating?</p> <p>NO</p> <p>Is the compressor operating?</p> <p>NO</p> <p>“WAIT” message is displayed (for 3 seconds) when performing cooling, defrost and heating operations from the remote control.</p> <p>NO</p> <p>Is the compressor rotation speed low?</p> <p>NO</p> <p>Check which control “Determination control of compressor rotation speed” or “Protective control by controlling compressor rotation speed” is appropriate to this phenomenon.</p> <p>Are the (1) temperature conditions of room and outdoor air close to the rated conditions?</p> <p>NO</p> <p>The unit is operating normally but is operating under the control for protecting compressor or other respective parts.</p>	<p>It is normal. (This unit is designed to start in the soft start mode by detecting the under dome temperature of compressor when it restart after power reset.)</p> <p>It is necessary to replace to higher capacity one or two install additional unit.</p> <p>Compressor refrigerant oil protection control at starting is activated. For the contents of control, refer to the compressor start control of the microcomputer control functions.</p> <p>Compressor may be stopped by the error detection control. For the contents of control, refer to anomalous stop control by controlling compressor rotation speed of microcomputer control functions.</p> <p>Inspect the followings.</p> <ul style="list-style-type: none"> • Minor clogging of filter • Minor clogging of heat exchanger • Minor short-circuit • Minor shortage of refrigerant amount • Poor compression of compressor <p>Considering appropriate operation control, check suspicious points. Inspect the followings for reference.</p> <ul style="list-style-type: none"> • Major clogging of filter • Major clogging of heat exchanger • Major short-circuit • Major shortage of refrigerant amount • Compressor protection ON • Indoor fan tap • Valid setting of silent mode

Note:

Error code Remote control: None	LED	Green	Red	Content Earth leakage breaker activated
	Indoor	Stays OFF	Stays OFF	
	Outdoor	Stays OFF	Stays OFF	

1. Applicable model
2. Error detection method
3. Condition of error displayed
4. Presumable cause
<ul style="list-style-type: none"> • Defective compressor • Noise

5. Troubleshooting	
Diagnosis	Countermeasure
<pre> graph TD A{Are OK the insulation resistance and resistance between terminals (1) of compressor? (1)0.722Ω or more at 20°C (Model FDC71VNX-W)} -- NO --> B[Replace compressor.*] A -- YES --> C{Is insulation of respective harnesses OK? Is any harness bitten between pannel and casing or etc?} C -- NO --> D[Secure insulation resistance.] C -- YES --> E[Check the outdoor unit grounding wire/earth leakage breaker.] </pre>	
<p>Check of the outdoor unit grounding wire/earth leakage breaker</p> <p>① Run an independent grounding wire from the grounding screw of outdoor unit to the grounding terminal on the distribution panel. (Do not connect to another grounding wire.)</p> <p>② In order to prevent malfunction of the earth leakage breaker itself, confirm that it is conformed to higher harmonic regulation.</p> <p>* Insulation resistance of compressor</p> <ul style="list-style-type: none"> • Immediately after installation or when the unit has been left for long time without power source, the insulation resistance may drop to a few MΩ because of refrigerant migrated in the compressor. <p>When the earth breaker is activated at lower insulation resistance, check the following points.</p> <p>① Check if the earth leakage breaker is conformed to higher harmonic regulation or not.</p> <p>Since the unit is equipped with inverter, it is necessary to use components conformed to higher harmonic regulation in order to prevent malfunction of earth leakage breaker.</p>	

Note:

Error code Remote control: None	LED	Green	Red	Content Excessive noise/vibration (1/3)
	Indoor	-	-	
	Outdoor	-	-	

1. Applicable model
2. Error detection method
3. Condition of error displayed
4. Presumable cause

5. Troubleshooting	
Diagnosis	Countermeasure
<pre> graph TD D1{Does noise/vibration occur during or soon after stopping operation of air-conditioner?} D2{[Installation work] Does noise/vibration occur not only from the air-conditioner but also from entire building?} D3{Does the installation of indoor/outdoor unit loose?} D4{Are pipes touching the wall, etc?} D5{[Product] Does noise/vibration occur from operating fan (fan only)?} D6{Is there a fan or louver touching other components?} End[To next page] D1 -- NO --> C1[If excessive noise/vibration persists when sufficient time has elapsed after stopping the unit, it is considered that the air-conditioner is not the source.] D1 -- YES --> D2 D2 -- YES --> D3 D2 -- NO --> D4 D3 -- YES --> C2[Check the installed condition carefully, and correct the position or insert rubber cushions or others into the gap, if necessary.] D3 -- NO --> D4 D4 -- YES --> C3[Prevent the vibration from transmitting to wall and etc by fixing pipes on the wall or wrapping rubber cushion around the pipe which goes through the hole in the wall or applying other appropriate means.] D4 -- NO --> C4[Strength of ceiling wall, floor, etc. may be insufficient. Review the installing position or reinforce it.] D5 -- YES --> D6 D5 -- NO --> C5[When the heat exchanger or filter is clogged, clean them. In case that the unit is installed at the site where background noise is very low, small noise from indoor unit can be heard, but it is normal. Before installation, check for background noise. If background noise is very low, convince client prior to installation.] D6 -- YES --> C6[Check for leaning of installed unit or anomalous mounting of fan, louver or motor and specify the contacting point and correct it.] D6 -- NO --> C5 </pre>	<p>If excessive noise/vibration persists when sufficient time has elapsed after stopping the unit, it is considered that the air-conditioner is not the source.</p> <p>Check the installed condition carefully, and correct the position or insert rubber cushions or others into the gap, if necessary.</p> <p>Prevent the vibration from transmitting to wall and etc by fixing pipes on the wall or wrapping rubber cushion around the pipe which goes through the hole in the wall or applying other appropriate means.</p> <p>Strength of ceiling wall, floor, etc. may be insufficient. Review the installing position or reinforce it.</p> <p>Check for leaning of installed unit or anomalous mounting of fan, louver or motor and specify the contacting point and correct it.</p> <p>When the heat exchanger or filter is clogged, clean them. In case that the unit is installed at the site where background noise is very low, small noise from indoor unit can be heard, but it is normal. Before installation, check for background noise. If background noise is very low, convince client prior to installation.</p>

Note:

Error code Remote control: None	LED	Green	Red	Content Excessive noise/vibration (2/3)
	Indoor	-	-	
	Outdoor	-	-	

1. Applicable model
2. Error detection method
3. Condition of error displayed
4. Presumable cause

5. Troubleshooting	
Diagnosis	Countermeasure
	<p>Rearrange the piping to avoid contact with the casing.</p> <p>It is noise/vibration that is generated when the refrigerant gas or liquid flow through inside of piping of air-conditioner. It is likely to occur particularly during cooling or defrost operation in the heating mode. It is normal.</p> <p>The noise/vibration occurs when the refrigerant starts or stops flowing. It is normal.</p> <p>When the defrost operation starts or stops during heating, the refrigerant flow is reversed due to switching 4-way valve. This causes a large change in pressure which produces a blowing sound. It may accompany also the hissing sounds as mentioned above. They are normal.</p> <p>After the start or stop of heating operation or during defrost operation, abrupt changes in temperature cause resin parts to shrink or expand. This is normal.</p> <p>It is the sound produced by the drain pump that discharges drain from the indoor unit. The pump continues to run for 5 minutes after stopping the cooling operation. This is normal.</p> <p>Apply the damper sealant at places considered to be the sources such as the pressure reducing mechanism (expansion valve), capillary, etc.</p>

Note:

Error code Remote control: None	LED	Green	Red	Content Excessive noise/vibration (3/3)
	Indoor	–	–	
	Outdoor	–	–	

<p>1. Applicable model</p> <p>2. Error detection method</p> <p>3. Condition of error displayed</p> <p>4. Presumable cause</p> 	<p>5. Troubleshooting</p> <table border="1" style="width: 100%;"> <thead> <tr> <th style="width: 50%;">Diagnosis</th> <th style="width: 50%;">Countermeasure</th> </tr> </thead> <tbody> <tr> <td style="text-align: center;"> <div style="border: 1px solid black; padding: 5px; width: fit-content; margin: 0 auto;">From previous page</div> <p style="text-align: center;">↓</p> <div style="border: 1px solid black; padding: 10px; width: fit-content; margin: 0 auto;"> <p style="text-align: center;">[Adjustment during commissioning]</p> <p style="text-align: center;">Does noise/vibration occur when the cooling/heating operation is in anomalous condition?</p> </div> <p style="text-align: center;">↓</p> <p style="text-align: center;">YES →</p> </td> <td> <p>If insufficient cooling/heating problem happens due to anomalous operating conditions at cooling/heating, followings are suspicious.</p> <ul style="list-style-type: none"> • Overcharge of refrigerant • Insufficient charge of refrigerant • Intrusion of air, nitrogen, etc. <p>In such occasion, it is necessary to recover refrigerant, vacuum-dry and recharge refrigerant.</p> <p>* Since there could be many causes of noise/vibration, the above do not cover all. In such case, check the conditions when, where, how the noise/vibration occurs according to following check point.</p> <ul style="list-style-type: none"> • Indoor/outdoor unit • Cooling/heating/fan mode • Startup/stop/during operation • Operating condition (Indoor/outdoor air temperatures, pressure) • Time it occurred • Operation data retained by the remote control such as compressor rotation speed, heat exchanger temperature, EEV opening degree, etc. • Tone (If available, record the noise) • Any other anomalies </td> </tr> </tbody> </table>	Diagnosis	Countermeasure	<div style="border: 1px solid black; padding: 5px; width: fit-content; margin: 0 auto;">From previous page</div> <p style="text-align: center;">↓</p> <div style="border: 1px solid black; padding: 10px; width: fit-content; margin: 0 auto;"> <p style="text-align: center;">[Adjustment during commissioning]</p> <p style="text-align: center;">Does noise/vibration occur when the cooling/heating operation is in anomalous condition?</p> </div> <p style="text-align: center;">↓</p> <p style="text-align: center;">YES →</p>	<p>If insufficient cooling/heating problem happens due to anomalous operating conditions at cooling/heating, followings are suspicious.</p> <ul style="list-style-type: none"> • Overcharge of refrigerant • Insufficient charge of refrigerant • Intrusion of air, nitrogen, etc. <p>In such occasion, it is necessary to recover refrigerant, vacuum-dry and recharge refrigerant.</p> <p>* Since there could be many causes of noise/vibration, the above do not cover all. In such case, check the conditions when, where, how the noise/vibration occurs according to following check point.</p> <ul style="list-style-type: none"> • Indoor/outdoor unit • Cooling/heating/fan mode • Startup/stop/during operation • Operating condition (Indoor/outdoor air temperatures, pressure) • Time it occurred • Operation data retained by the remote control such as compressor rotation speed, heat exchanger temperature, EEV opening degree, etc. • Tone (If available, record the noise) • Any other anomalies
Diagnosis	Countermeasure				
<div style="border: 1px solid black; padding: 5px; width: fit-content; margin: 0 auto;">From previous page</div> <p style="text-align: center;">↓</p> <div style="border: 1px solid black; padding: 10px; width: fit-content; margin: 0 auto;"> <p style="text-align: center;">[Adjustment during commissioning]</p> <p style="text-align: center;">Does noise/vibration occur when the cooling/heating operation is in anomalous condition?</p> </div> <p style="text-align: center;">↓</p> <p style="text-align: center;">YES →</p>	<p>If insufficient cooling/heating problem happens due to anomalous operating conditions at cooling/heating, followings are suspicious.</p> <ul style="list-style-type: none"> • Overcharge of refrigerant • Insufficient charge of refrigerant • Intrusion of air, nitrogen, etc. <p>In such occasion, it is necessary to recover refrigerant, vacuum-dry and recharge refrigerant.</p> <p>* Since there could be many causes of noise/vibration, the above do not cover all. In such case, check the conditions when, where, how the noise/vibration occurs according to following check point.</p> <ul style="list-style-type: none"> • Indoor/outdoor unit • Cooling/heating/fan mode • Startup/stop/during operation • Operating condition (Indoor/outdoor air temperatures, pressure) • Time it occurred • Operation data retained by the remote control such as compressor rotation speed, heat exchanger temperature, EEV opening degree, etc. • Tone (If available, record the noise) • Any other anomalies 				

Note:

Error code Remote control: None	LED	Green	Red	Content Louver motor failure
	Indoor	Keeps flashing	Stays OFF	
	Outdoor	Keeps flashing	Stays OFF	

1. Applicable model
FDT, FDTC, FDE series

2. Error detection method

3. Condition of error displayed

4. Presumable cause
<ul style="list-style-type: none"> • Defective LM • LM wire breakage • Faulty indoor unit control PCB

5. Troubleshooting	
Diagnosis	Countermeasure
<p>▲ Check at the indoor unit side.</p> <pre> graph TD Start[Operate after waiting for more than 1 minute.] --> Q1{Does the louver operate at the power on?} Q1 -- NO --> Q2{Is LM wiring broken?} Q2 -- YES --> C1[Repair wiring.] Q2 -- NO --> Q3{Is LM locked?} Q3 -- NO --> C2[Defective indoor unit control PCB → Replace.] Q3 -- YES --> C3[Replace LM.] Q1 -- YES --> Q4{Is the louver operable with the remote control?} Q4 -- YES --> C4[Normal] Q4 -- NO --> C5[Adjust LM lever and then check again.] </pre> <p style="text-align: center;">LM: louver motor</p>	

Note:

Error code Remote control: None	LED	Green	Red	Content Power source system error (Power source to indoor unit control PCB)
	Indoor	Stays OFF	Stays OFF	
	Outdoor	Keeps flashing	2-time flash	

1. Applicable model
2. Error detection method
3. Condition of error displayed
4. Presumable cause

- Misconnection or breakage of connecting wires
- Blown fuse
- Faulty transformer
- Faulty indoor unit control PCB
- Broken harness
- Faulty outdoor unit control PCB (Noise filter)

5. Troubleshooting	
Diagnosis	Countermeasure
<pre> graph TD Q1{Is AC220/240V detected between ① and ② on the terminal block of indoor unit?} Q2{Are fuses OK (F1,2)} Q3{Is DC5V detected between ④-⑤ of CNW2?} Q4{Is JX1 open?} Q5{Is AC380/415V for 3-phase unit detected between ①, ② and ③ on the terminal block of outdoor unit or is AC220/240V for 1-phase unit detected between ① and ② on the terminal block of outdoor unit?} Q6{Is the check of resistance between ①-③ of CNW0 OK?} Q7{Is the checked result of resistance of FM, LM, etc OK?} Q1 -- YES --> Q2 Q1 -- NO --> Q5 Q2 -- YES --> Q3 Q2 -- NO --> Q6 Q3 -- YES --> Q4 Q3 -- NO --> C1[Defective indoor unit control PCB → Replace.] Q4 -- YES --> C2[Defective indoor unit control PCB → Replace.] Q4 -- NO --> C3[Open JX1.] Q5 -- YES --> C4[Misconnection or breakage of connecting wires.] Q5 -- NO --> C5[Defective outdoor unit control PCB (Noise filter). → Replace.] Q6 -- YES --> C6[Replace fuse.] Q6 -- NO --> C7[Defective indoor unit control PCB → Replace.] Q7 -- YES --> C8[Replace fuse.] Q7 -- NO --> C9[Replace FM, LM, etc.] </pre>	<p>Defective outdoor unit control PCB (Noise filter). → Replace.</p> <p>Misconnection or breakage of connecting wires.</p> <p>Defective indoor unit control PCB → Replace.</p> <p>Replace FM, LM, etc.</p> <p>Replace fuse.</p> <p>Defective indoor unit control PCB → Replace.</p> <p>Open JX1.</p> <p>Defective indoor unit control PCB → Replace.</p>

Note:

Error code Remote control: None	LED	Green	Red	Content Power source system error (Power source to remote control)
	Indoor	Keeps flashing	Stays OFF	
	Outdoor	Keeps flashing	2-time flash	

1. Applicable model

2. Error detection method

3. Condition of error displayed

4. Presumable cause

- Remote control wire breakage/short-circuit
- Defective remote control
- Malfunction by noise
- Broken harness
- Faulty indoor unit control PCB

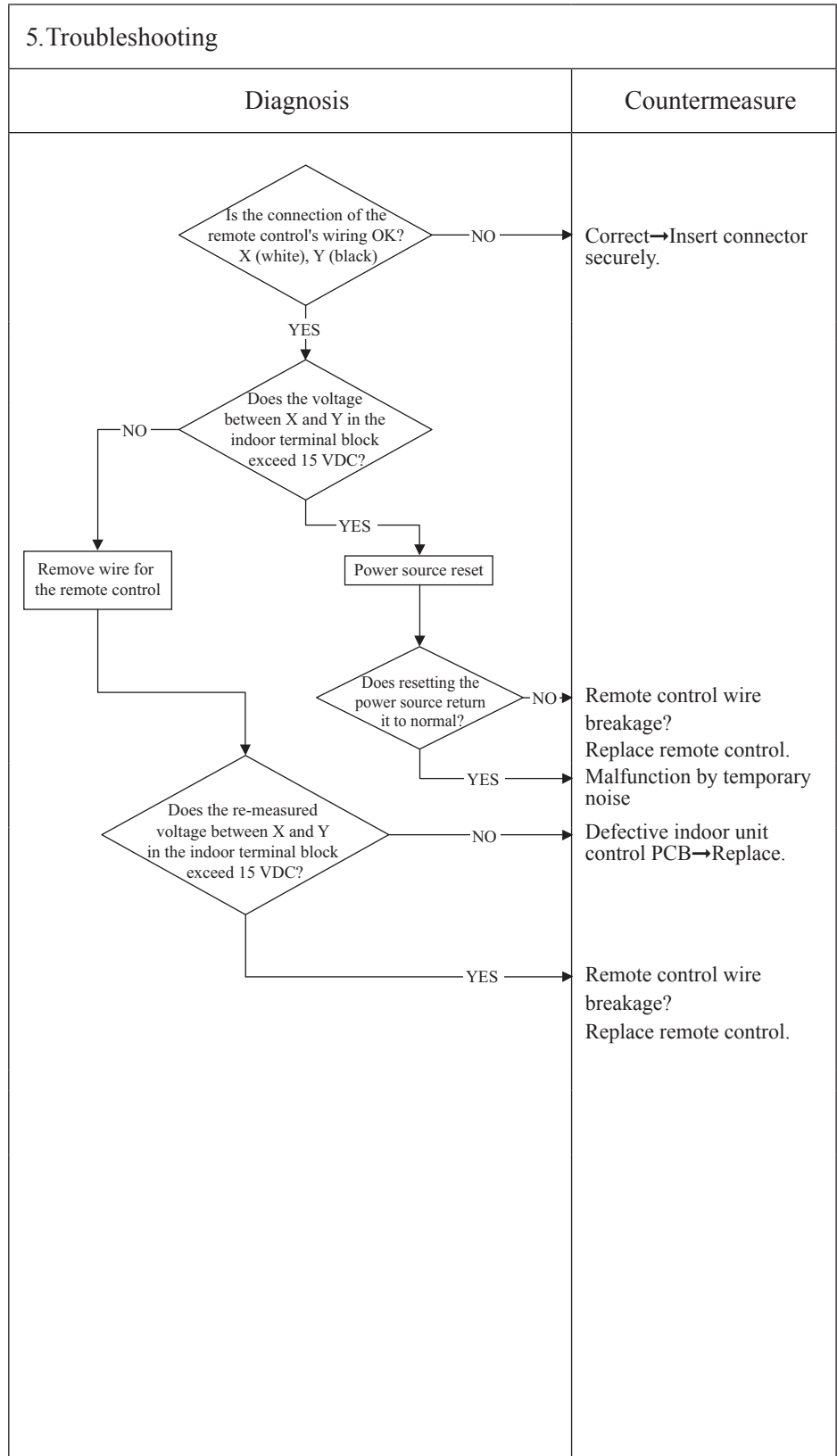

Note:

Error code Remote control: INSPECT I/U	LED	Green	Red	Content INSPECT I/U (When 1 or 2 remote controls are connected)
	Indoor	Keeps flashing	Stays OFF	
	Outdoor	Keeps flashing	2-time flash	

1. Applicable model
2. Error detection method Communication between indoor unit and remote control is disabled for more than 30 minutes after the power on.
3. Condition of error displayed Same as above
4. Presumable cause <ul style="list-style-type: none"> • Improper setting • Surrounding environment • Defective remote control communication circuit • Faulty indoor unit control PCB

5. Troubleshooting	
Diagnosis	Countermeasure
<pre> graph TD Q1{Are 2 units of remote control connected?} Q2{Does it become normal?} Q3{Do more than one indoor units have the same address?} Q4{Are remote control wires laid along high voltage wires?} Q5{Does DM start 60 seconds later automatically?} Q1 -- YES --> S1[Set one remote control for "Master" and the other for "Slave"] S1 --> Q2 Q2 -- YES --> C1[Normal] Q2 -- NO --> Q3 Q3 -- YES --> C2[Set address again. (SW2 on indoor unit control PCB)] Q3 -- NO --> Q4 Q4 -- YES --> C3[Separate remote control wires from high voltage wires.] Q4 -- NO --> S2[Disconnect the connecting wire ③ between the indoor and outdoor unit.] S2 --> S3[Power source reset] S3 --> Q5 Q5 -- YES --> C4[Defective indoor unit control PCB -> Replace.] Q5 -- NO --> C5[Defective remote control -> Change.] Note1[Note (1) Use SW1 to set at master or slave.] Note2[Note (2) "Slave" is displayed on the remote control LCD.] Note3[Note (3) Only indoor unit with drain pump] S1 --- Note1 Q1 --- Note2 Note3 --- Q5 </pre>	

Note: If any error is detected 30 minutes after displaying “WAIT” on the remote control, the display changes to “INSPECT I/U”.

Error code Remote control: INSPECT I/U	LED	Green	Red	Content INSPECT I/U (Connection of 3 units or more remote controls)
	Indoor	Keeps flashing	Stays OFF	
	Outdoor	Keeps flashing	2-time flash	

1. Applicable model
2. Error detection method
Indoor unit cannot communicate for more than 30 minutes after the power on with remote control.
3. Condition of error displayed
Same as above
4. Presumable cause
<ul style="list-style-type: none"> • Improper setting • Surrounding environment • Defective remote control communication circuit • Faulty indoor unit control PCB • Faulty outdoor unit control PCB

5. Troubleshooting	
Diagnosis	Countermeasure
<pre> graph TD Q1{Are more than 3 units of remote control connected?} -- YES --> C1[Reduce to 2 units or less.] Q1 -- NO --> Q2{Does remote control display "Slave"?} Q2 -- YES --> C2[Change remote control setting to "Master". (SW1 on remote control PCB)] Q2 -- NO --> Q3{Do more than one indoor units have the same address?} Q3 -- YES --> C3[Change address. (SW2 on indoor unit control PCB)] Q3 -- NO --> Q4{Is it set to a slave indoor unit? (SW5-1, 2)} Q4 -- YES --> C4[Change to master. (SW5-1, 2 on indoor unit control PCB)] Q4 -- NO --> Q5{Is there loose or wrong connection at the terminal of wiring between indoor and outdoor units?} Q5 -- YES --> C5[Correct.] Q5 -- NO --> Q6{Is the grounding wire connected properly?} Q6 -- YES --> Q7{Is approx. DC20V detected between ②-③ on the outdoor unit terminal block?} Q6 -- NO --> C6[Correct.] Q7 -- NO --> C7[Defective outdoor unit control PCB -> Replace.] Q7 -- YES --> Q8{Is approx. DC20V detected between ②-③ on the indoor unit terminal block?} Q8 -- NO --> C8[Broken connecting wire -> Correct.] Q8 -- YES --> C9[Defective indoor unit control PCB -> Replace.] </pre>	

Note: If any error is detected 30 minutes after displaying “WAIT” on the remote control, the display changes to “INSPECT I/U”.

Error code Remote control: 🟡WAIT🟡	LED	Green	Red	Content Communication error at initial operation (1/3)
	Indoor	Keeps flashing	Stays OFF	
	Outdoor	Keeps flashing	2-time flash	

1. Applicable model

2. Error detection method

3. Condition of error displayed

4. Presumable cause
- Faulty indoor unit control PCB
 - Defective remote control
 - Broken remote control wire
 - Faulty outdoor unit control PCB
 - Broken connection wires

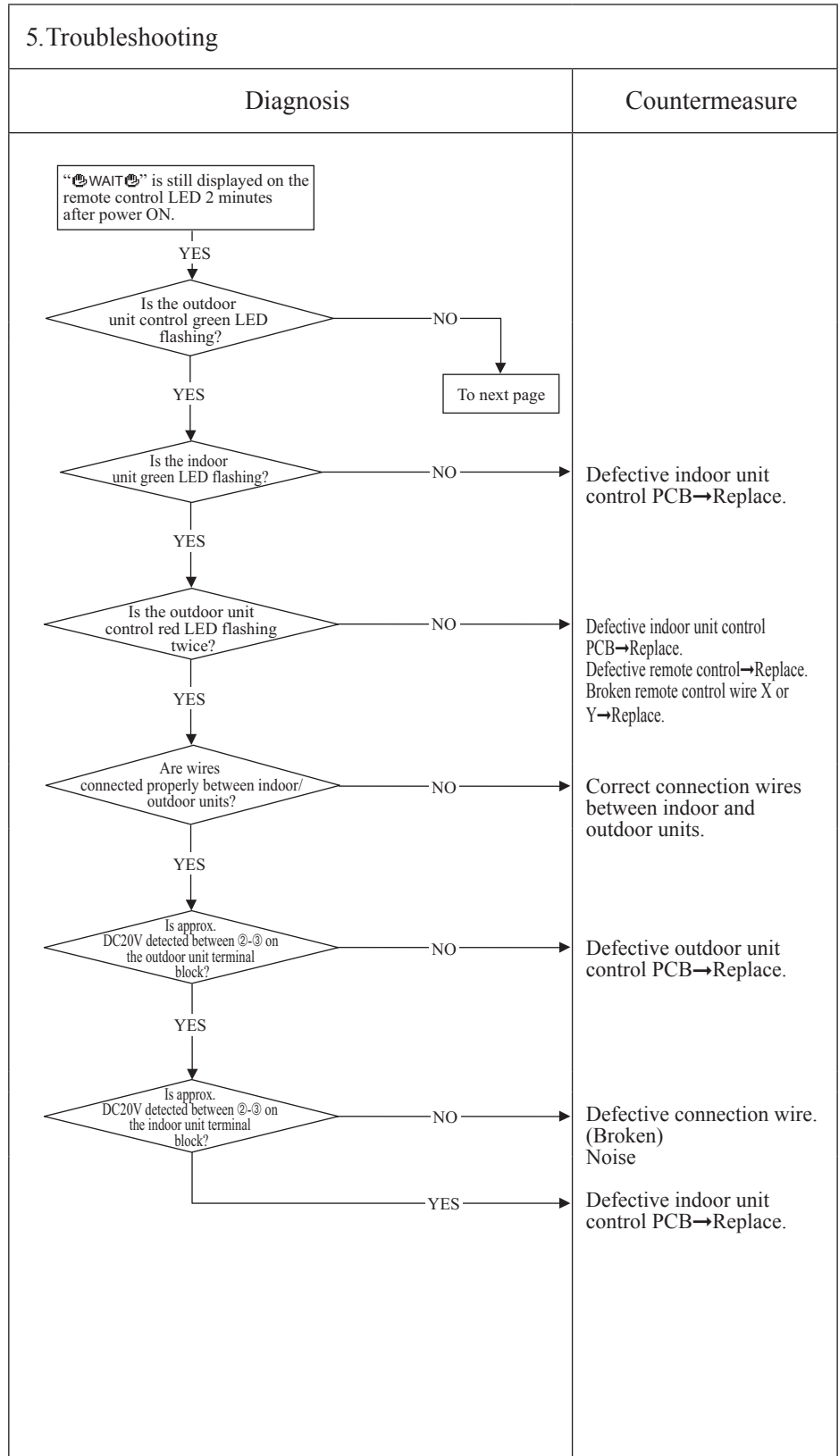

Note:

Error code Remote control: WAIT	LED	Green	Red	Content Communication error at initial operation (2/3)
	Indoor	Keeps flashing	Stays OFF	
	Outdoor	Keeps flashing	2-time flash	

1. Applicable model
2. Error detection method
3. Condition of error displayed
4. Presumable cause

- Faulty noise filter
- Faulty indoor unit control PCB
- Faulty outdoor unit control PCB
- Faulty inverter PCB
- Faulty fan motor

5. Troubleshooting	Diagnosis	Countermeasure
	<p>Diagnosis for when the outdoor unit control PCB LED is turned off</p> <pre> graph TD Start[From previous page] --> Step1[Shut down the breaker and back on again the breaker 3 minutes later.] Step1 --> Dec1{Does it reset normally?} Dec1 -- YES --> C1[Normal. (Malfunction by noise)] Dec1 -- NO --> Dec2{Is the outdoor unit control power source fuse (71:20A) blown?} Dec2 -- YES --> Note1[Note (1) 1-phase model only] Note1 --> Step2[To check method for inverter PCB before replacment of blown power source fuse.] Step2 --> Dec3{Is AC220/240V or AC380/415V detected at the noise filter secondary side?} Dec3 -- NO --> C2[Replace noise filter.] Dec3 -- YES --> Dec4{Is DC255-310V detected at CNA2?} Dec4 -- NO --> C3[Check connection of diode stack and electrolytic capacitor by refering main electrical circuit diagram] Dec4 -- YES --> Dec5{Is fuse [250V, 2A] on the outdoor unit control PCB blown?} Dec5 -- YES --> C4[Defective outdoor unit control PCB→Replace.] Dec5 -- NO --> Dec6{Is DC5V detected on the outdoor unit control PCB (Between ①-④ of CNV)?} Dec6 -- NO --> C5[Defective outdoor unit control PCB→Replace.] Dec6 -- YES --> Dec7{Is DC5V detected if the connector of outdoor fan motor is disconnected?} Dec7 -- NO --> C6[Defective outdoor fan motor] Dec7 -- YES --> Dec8{Is DC5V detected if the inverter power source connector (CN12) is disconnected?} Dec8 -- NO --> C7[Defective inverter PCB →Replace.] Dec8 -- YES --> C8[Defective outdoor unit control PCB→Replace.] </pre>	

Note:

Error code Remote control: 🏠 WAIT 🏠	LED	Green	Red	Content Communication error at initial operation (3/3)
	Indoor	Keeps flashing	Stays OFF	
	Outdoor	Keeps flashing	2-time flash	

1. Applicable model

2. Error detection method

3. Condition of error displayed

4. Presumable cause

- Blown fuse
- Faulty noise filter
- Faulty inverter PCB
- Faulty reactor
- Faulty electrolytic capacitor

5. Troubleshooting

Diagnosis	Countermeasure
<p>Method to check for inverter PCB before replacement of blown power source fuse.</p> <p>From previous page</p> <pre> graph TD Start([From previous page]) --> D1{Is there a short-circuit between phases of the noise filter?} D1 -- YES --> C1[Replace the noise filter.] D1 -- NO --> D2{Is there a short-circuit between phases of inverter PCB input terminals?} D2 -- YES --> C2[Replace the inverter PCB.] D2 -- NO --> D3{Is there any crack, burning on the power transistor module?} D3 -- YES --> C2 D3 -- NO --> D4{Is the reactor OK?} D4 -- NO --> C3[Replace the reactor.] D4 -- YES --> D5{Is the electrolytic capacitor OK?} D5 -- NO --> C4[Replace the electrolytic capacitor.] D5 -- YES --> C5[Replace the power source fuse.] </pre>	

Note:

Error code Remote control: None	LED	Green	Red	Content No display
	Indoor	Stays OFF	Stays OFF	
	Outdoor	Stays OFF	Stays OFF	

1. Applicable model	5. Troubleshooting		
	Diagnosis	Countermeasure	
2. Error detection method	<pre> graph TD Start[Remote control does not display anything after the power on.] --> D1{Is DC10V or higher detected at remote control connection terminals?} D1 -- YES --> C1[Defective remote control] D1 -- NO --> D2{Is DC10V or higher detected on remote control wires if the remote control is removed?} D2 -- YES --> C2[Defective remote control] D2 -- NO --> D3{Are wires connected properly between the indoor/outdoor units?} D3 -- NO --> C3["Defective connecting wire Defective remote control wire (Short-circuit, etc.)"] D3 -- YES --> C4[Defective indoor unit control PCB -> Replace.] </pre>		
3. Condition of error displayed			
4. Presumable cause	<ul style="list-style-type: none"> • Faulty indoor unit control PCB • Defective remote control • Broken remote control wire 		

Note:

Error code Remote control: E1	LED	Green	Red	Content
	Indoor	Keeps flashing	Stays OFF	
	Outdoor	Keeps flashing	Stays OFF	

Remote control communication circuit error

1. Applicable model
2. Error detection method
When normal communication between the remote control and the indoor unit is interrupted for more than 2 minutes. (Detectable only with the remote control)
3. Condition of error displayed
Same as above
4. Presumable cause
<ul style="list-style-type: none"> • Defective communication circuit between remote control-indoor unit • Noise • Defective remote control • Faulty indoor unit control PCB

5. Troubleshooting	
Diagnosis	Countermeasure
<pre> graph TD A{Is it possible to reset normally by the power reset?} -- YES --> B[Malfunction by noise Check peripheral environment.] A -- NO --> C[Turn SW7-1 to OFF → ON. Remove the wire ③ connecting between indoor/outdoor units.] C --> D[Power source reset] D --> E{Does the drain pump restart automatically 1 minute later? (1)} E -- YES --> F[Defective indoor unit control PCB → Replace.] E -- NO --> G[Connect the wire ③ connecting between indoor/outdoor units.] G --> H[Move to E5. (Communication error during operation) Check.] </pre>	

Note: If the indoor unit cannot communicate normally with the remote control for 180 seconds, the indoor unit PCB starts to reset automatically.

Error code Remote control: E5	LED	Green	Red	Content Communication error during operation
	Indoor	Keeps flashing	2-time flash	
	Outdoor	Keeps flashing	See below	

1. Applicable model
2. Error detection method
When normal communication between indoor and outdoor unit is interrupted for more than 2 minutes.
3. Condition of error displayed
Same as above is detected during operation.
4. Presumable cause
<ul style="list-style-type: none"> • Unit No. setting error • Broken remote control wire • Faulty remote control wire connection • Faulty outdoor unit control PCB

5. Troubleshooting	
Diagnosis	Countermeasure
<p>● In case that the outdoor unit red LED flashes 2-time</p> <p>Note (1) Inspect faulty connections (disconnection, looseness) on the outdoor unit terminal block.</p> <p>Is the connection of signal wires at the outdoor unit side OK?</p> <p>NO → Repair signal wires.</p> <p>YES</p> <p>Note (2) Check for faulty connection or breakage of signal wires between indoor-outdoor units.</p> <p>Is the connection of signal wires between indoor-outdoor units OK?</p> <p>NO → Repair signal wires.</p> <p>YES</p> <p>Power source reset</p> <p>Has the remote control LCD returned to normal state?</p> <p>NO → To the diagnosis of “WAIT”.</p> <p>YES → Unit is normal. (Malfunction by temporary noise, etc.)</p> <p>● In case that the outdoor unit red LED stays OFF</p> <p>Power source reset</p> <p>Has the remote control LCD returned to normal state?</p> <p>NO → Defective outdoor unit PCB (Defective network communication circuit) → Replace.</p> <p>YES → Unit is normal. (Malfunction by temporary noise, etc.)</p>	

Note: Pressing the pump-down switch cancels communications between indoor and outdoor unit so that “communication error-E5” is displayed on indoor unit and remote control, but it is normal.

Error code Remote control: E6	LED	Green	Red	Content Indoor heat exchanger temperature sensor anomaly
	Indoor	Keeps flashing	1-time flash	
	Outdoor	Keeps flashing	Stays OFF	

1. Applicable model

2. Error detection method

Anomalously low temperature or high temperature (resistance) is detected on the indoor heat exchanger temperature sensor (Thi-R1, R2 or R3).

3. Condition of error displayed

- When the temperature sensor detects -50°C or lower for 5 seconds continuously, the compressor stops. After 3-minute delay, the compressor starts again automatically, but if this error occurs again within 60 minutes after the initial detection.
- Or if 70°C or higher is detected for 5 seconds continuously.

4. Presumable cause

- Defective indoor heat exchanger temperature sensor connector
- Indoor heat exchanger temperature sensor anomaly
- Faulty indoor unit control PCB

5. Troubleshooting

Diagnosis	Countermeasure
<pre> graph TD Q1{Is the connection of indoor heat exchanger temperature sensor connector OK?} Q2{Are characteristics of indoor heat exchanger temperature sensor OK?} C1[Correct. -> Insert connector securely.] C2[Defective indoor heat exchanger temperature sensor -> Replace.] C3[Defective indoor unit control PCB -> Replace. (Defective indoor heat exchanger temperature sensor input circuit)] Q1 -- NO --> C1 Q1 -- YES --> Q2 Q2 -- NO --> C2 Q2 -- YES --> C3 </pre>	
<p>(Broken wire)</p> <p>(Short-circuit)</p>	

Note:

Error code Remote control: E7	LED	Green	Red	Content Return air temperature sensor anomaly
	Indoor	Keeps flashing	1-time flash	
	Outdoor	Keeps flashing	Stays OFF	

1. Applicable model

2. Error detection method

Anomalously low temperature or high temperature (resistance) is detected by indoor return air temperature sensor (Thi-A)

3. Condition of error displayed

- When the temperature sensor detects -50°C or lower for 5 seconds continuously, the compressor stops. After 3-minute delay, the compressor starts again automatically, but if this error occurs again within 60 minutes after the initial detection.

4. Presumable cause

- Defective return air temperature sensor connector
- Defective return air temperature sensor
- Faulty indoor unit control PCB

5. Troubleshooting

Diagnosis	Countermeasure
<p>Is the connection of return air temperature sensor connector OK?</p> <p>NO →</p> <p>YES →</p> <p>Are the characteristics of return air temperature sensor OK?</p> <p>NO →</p> <p>YES →</p>	<p>Correct. → Connect connector.</p> <p>Defective return air temperature sensor → Replace.</p> <p>Defective indoor unit control PCB → Replace. (Defective return air temperature sensor input circuit)</p>

Temperature-resistance characteristic

Temperature (°C)	Temperature sensor resistance (kΩ)
0	~16
10	~11
20	~7
25	5
30	~4
40	~3
50	~2

Note:

Error code Remote control: E8	LED	Green	Red	Content Heating overload operation
	Indoor	Keeps flashing	1-time flash	
	Outdoor	Keeps flashing	Stays OFF	

1. Applicable model

2. Error detection method
Indoor heat exchanger temperature sensor (Thi-R1, R2, R3)

3. Condition of error displayed
When it is detected 5 times within 60 minutes from initial detection or when the overload condition is detected for 6 minutes continuously.

4. Presumable cause

- Clogged air filter
- Defective indoor heat exchanger temperature sensor connector
- Defective indoor heat exchanger temperature sensor
- Anomalous refrigerant system

5. Troubleshooting

Diagnosis	Countermeasure
<pre> graph TD Q1{Is the air filter clogged?} -- YES --> C1[Wash.] Q1 -- NO --> Q2{Is the indoor heat exchanger temperature sensor connection OK?} Q2 -- NO --> C2[Defective indoor heat exchanger temperature sensor connector → Correct.] Q2 -- YES --> Q3{Are the characteristics of indoor heat exchanger temperature sensor OK? (2)} Q3 -- NO --> C3[Defective indoor heat exchanger temperature sensor → Replace.] Q3 -- YES --> R1[Check the error data with the remote control.] R1 --> Q4{Is the unit operating in the state of heating overload?} Q4 -- NO --> C4[Check refrigerant system.] Q4 -- YES --> C5[Adjust.] </pre>	
<p>Note (1) Judge if it is in the state of overload or not as follows.</p> <ul style="list-style-type: none"> • Is there any short-circuit of air? • Isn't there any fouling or clogging on the indoor heat exchanger? • Is the outdoor fan control normal? • Isn't the room and outdoor air temperature too high? <p>Note (2) For characteristics of indoor heat exchanger temperature sensor, see the error display E6.</p> <p style="text-align: center;">Indoor heat exchanger temperature (°C)</p>	

Note: During heating operation; After starting compressor, compressor rotation speed is decreased by detecting indoor heat exchanger temperature (Thi-R) in order to control high pressure.

Error code Remote control: E9	LED	Green	Red	Content	Drain trouble
	Indoor	Keeps flashing	1-time flash		
	Outdoor	Keeps flashing	Stays OFF		

1. Applicable model
FDT, FDTC, FDU, FDUM series
2. Error detection method
Float switch is activated
3. Condition of error displayed
If the float switch OPEN is detected for 3 seconds continuously or if float switch connector or wire is disconnected.
4. Presumable cause
<ul style="list-style-type: none"> • Defective indoor unit control PCB • Float switch setting error • Humidifier drain pump motor interlock setting error • Option equipment setting error • Drain piping error • Defective drain pump motor • Disconnection of drain pump motor wiring

5. Troubleshooting	
Diagnosis	Countermeasure
<pre> graph TD Start[Check the error data in the remote control.] --> Q1{Is there any overflow?} Q1 -- NO --> Q2{Is DC12V at CNI connector?} Q2 -- YES --> C1[Check float switch.] Q2 -- NO --> Q3{Is the CNI connected firmly?} Q3 -- NO --> C2[Defective indoor unit control PCB → Replace.] Q3 -- YES --> Q4{Is there any anomaly on the option equipment?} Q4 -- NO --> C3[Defective indoor unit control PCB → Replace.] Q4 -- YES --> C4[Check option equipment.] Q1 -- YES --> Q5{Is the humidifier connected?} Q5 -- YES --> Q6{Is the humidifier drain pump motor interlocked by the indoor unit function setting of remote control?} Q6 -- YES --> C5[Correct setting to "Humidifier drain pump motor interlock".] Q6 -- NO --> C6[Correct setting to "Humidifier drain pump motor interlock".] Q5 -- NO --> C6 Q6 --> Start2[Drain pump motor ON from the remote control] Start2 --> Q7{Does drain pump motor operate?} Q7 -- NO --> Q8{Is DC12V detected at CNR connector?} Q8 -- NO --> C7[Defective indoor unit control PCB → Replace.] Q8 -- YES --> C8[Check wiring of drain pump motor.] Q7 -- YES --> Q9{Is the drain piping unclogged? Is the drain pipe slope OK?} Q9 -- NO --> C9[Correct.] Q9 -- YES --> C10[Check drain pump motor.] </pre>	

Note: When this error occurred at power ON, disconnection of wire or connector of the float switch is suspected. Check and correct it (or replace it, if necessary).

Error code Remote control: E10	LED	Green	Red	Content Excessive number of connected indoor units (more than 17 units) by controlling with one remote control
	Indoor	Keeps flashing	Stays OFF	
	Outdoor	Keeps flashing	Stays OFF	

<p>1. Applicable model</p>	<p>5. Troubleshooting</p> <table border="1" style="width: 100%;"> <thead> <tr> <th style="width: 50%;">Diagnosis</th> <th style="width: 50%;">Countermeasure</th> </tr> </thead> <tbody> <tr> <td style="text-align: center;"> <pre> graph TD A{Are more than 17 indoor units connected to one remote control?} -- NO --> B[Defective remote control → Replace.] A -- YES --> C[Reduce to 16 or less units.] </pre> </td> <td></td> </tr> </tbody> </table>		Diagnosis	Countermeasure	<pre> graph TD A{Are more than 17 indoor units connected to one remote control?} -- NO --> B[Defective remote control → Replace.] A -- YES --> C[Reduce to 16 or less units.] </pre>	
Diagnosis	Countermeasure					
<pre> graph TD A{Are more than 17 indoor units connected to one remote control?} -- NO --> B[Defective remote control → Replace.] A -- YES --> C[Reduce to 16 or less units.] </pre>						
<p>2. Error detection method</p> <p>When it detects more than 17 of indoor units connected to one remote control</p>						
<p>3. Condition of error displayed</p> <p>Same as above</p>						
<p>4. Presumable cause</p> <ul style="list-style-type: none"> • Excessive number of indoor units connected • Defective remote control 						

Note:

Error code Remote control: E11	LED	Green	Red	Content Address setting error of indoor units
	Indoor	Keeps flashing	Stays OFF	
	Outdoor	Keeps flashing	Stays OFF	

1. Applicable model

2. Error detection method

IU address has been set using the “Master IU address set” function of remote control.

3. Condition of error displayed

Same as above

4. Presumable cause

Mistake of address setting method
(Address setting from remote control can't be done)

5. Troubleshooting

Diagnosis	Countermeasure
<pre> graph TD A[E11 occurs] --> B{Is "Master IU address set" function of remote control used?} B -- YES --> C[Change of address setting method] </pre> <p>In case the wiring is below and “Master IU address set” is used, E11 is appeared.</p>	<p>Change of address setting method Set the address by DIP switch SW2 on indoor unit control PCB.</p>

Note:

Error code Remote control: E14	LED	Green	Red	Content Communication error between master and slave indoor units
	Indoor	Keeps flashing	3-time flash	
	Outdoor	Keeps flashing	Stays Off	

1. Applicable model

2. Error detection method

When communication error between master and slave indoor units occurs

3. Condition of error displayed

Same as above

4. Presumable cause

- Unit address setting error
- Broken remote control wire
- Defective remote control wire connection
- Defective indoor unit control PCB

5. Troubleshooting

Diagnosis	Countermeasure
<pre> graph TD Q1{Is it OK the unit address setting for master and slave indoor units?} Q2{Is the remote control wiring between indoor units defective?} Q3{Is it restored by resetting the power source?} Q1 -- NO --> C1[Correct unit address setting.] Q1 -- YES --> Q2 Q2 -- YES --> C2[Correct wiring.] Q2 -- NO --> Q3 Q3 -- NO --> C3[Defective indoor unit control PCB -> Replace.] Q3 -- YES --> C4["• Malfunction by noise • Check surrounding environment."] </pre>	

Note (1) Set DIP switches SW5-1 and SW5-2 as shown in the following table.
(Factory default setting – “Master”)

		Indoor unit		
		Master	Slave-a	Slave-b
DIP switch	SW5-1	OFF	OFF	ON
	SW5-2	OFF	ON	OFF

Note:

Error code Remote control: E16	LED	Green	Red	Content Indoor fan motor anomaly
	Indoor	Keeps flashing	1-time flash	
	Outdoor	Keeps flashing	Stays OFF	

1. Applicable model

2. Error detection method

Detected by rotation speed of indoor fan motor

3. Condition of error displayed

- When actual rotation speed of indoor fan motor drops to lower than 200min^{-1} for 30 seconds continuously, the compressor and the indoor fan motor stop.
- After 2-seconds, it starts again automatically, but if this error occurs 4 times within 60 minutes after the initial detection.

4. Presumable cause

- Defective indoor unit control PCB
- Foreign material at rotational area of fan propeller
- Defective fan motor
- Dust on indoor unit control PCB
- Blown fuse
- External noise, surge

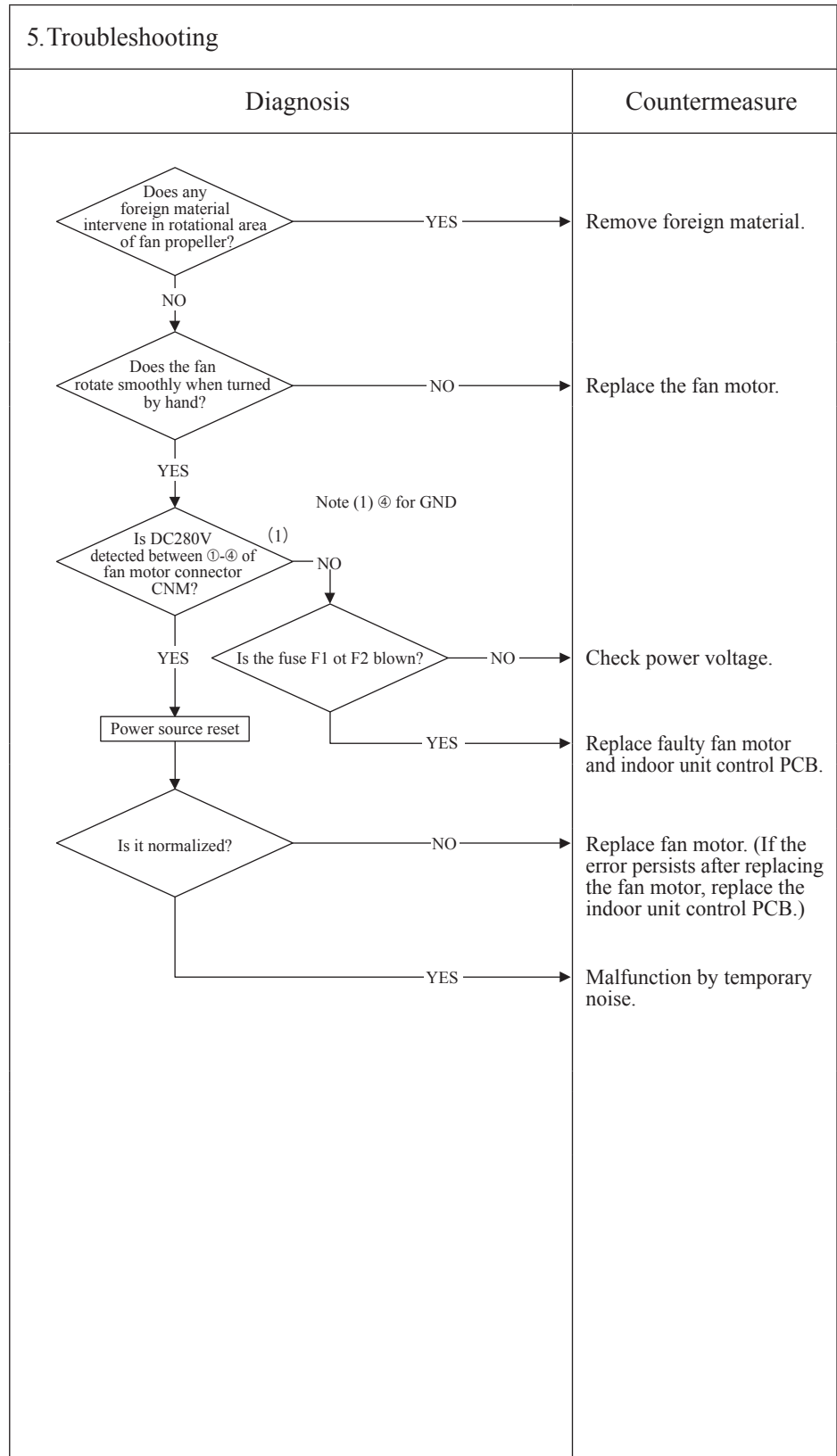

Note:

Error code Remote control: E18	LED	Green	Red	Content Address setting error of master and slave indoor units
	Indoor	Keeps flashing	1-time flash	
	Outdoor	Keeps flashing	Stays Off	

1. Applicable model

2. Error detection method

IU address has been set using the “Master IU address set” function of remote control.

3. Condition of error displayed

Same as above

4. Presumable cause

Same as above

5. Troubleshooting

Diagnosis	Countermeasure
<pre> graph TD A[E18 occurs] --> B{Is "Master IU address set" function of remote control used?} B -- YES --> C[Countermeasure] </pre>	<ul style="list-style-type: none"> • In cases of RC-EX3A Menu → Service setting → IU settings → Select IU • In cases of RC-E5 Return address No. to “IU ...” using [▲] or [▼] button.

Note:

Error code Remote control: E19	LED	Green	Red	Content Indoor unit operation check, drain pump motor check setting error
	Indoor	Keeps flashing	1-time flash	
	Outdoor	Keeps flashing	Stays OFF	

1.Applicable model

2.Error detection method

After indoor operation check, when the communication between indoor and outdoor unit is established and SW7-1 is still kept ON.

3.Condition of error displayed

Same as above

4.Presumable cause

Mistake in SW7-1 setting (Due to forgetting to turn OFF SW7-1 after indoor operation check)

5.Troubleshooting	
Diagnosis	Countermeasure
<pre> graph TD Start[E19 occurs when the power ON] --> Decision{Is SW7-1 on the indoor unit control PCB ON?} Decision -- NO --> Countermeasure1[Defective indoor unit control PCB (Defective SW7) -> Replace.] Decision -- YES --> Countermeasure2[Turn SW7-1 on the indoor unit control PCB OFF and reset the power.] </pre>	<p>Defective indoor unit control PCB (Defective SW7)→Replace.</p> <p>Turn SW7-1 on the indoor unit control PCB OFF and reset the power.</p>

Note:

Error code Remote control: E20	LED	Green	Red	Content Indoor fan motor rotation speed anomaly
	Indoor	Keeps flashing	1-time flash	
	Outdoor	Keeps flashing	Stays OFF	

1. Applicable model

2. Error detection method

Detected by rotation speed of indoor fan motor

3. Condition of error displayed

When the actual fan rotation speed does not reach to the speed of [required speed -50 min⁻¹(FDU: -500 min⁻¹)] after 2 minutes have been elapsed since the fan motor rotation speed command was output, the unit stops by detecting indoor fan motor anomaly.

- 4. Presumable cause**
- Defective indoor unit control PCB
 - Foreign material at rotational area of fan propeller
 - Defective fan motor
 - Dust on indoor unit control PCB
 - Blown fuse
 - External noise, surge

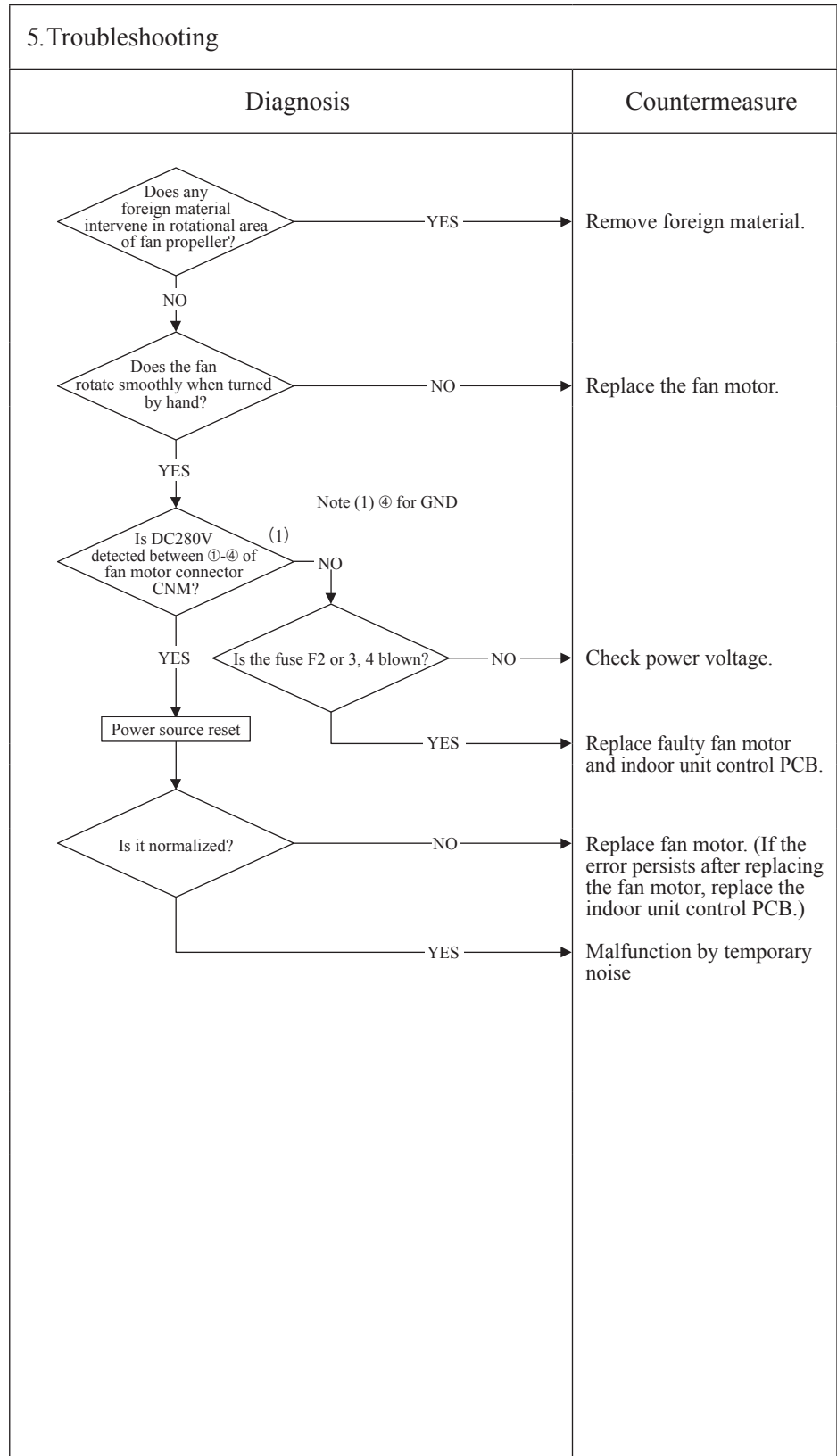

Note:

Error code Remote control: E28	LED	Green	Red	Content Remote control temperature sensor anomaly
	Indoor	Keeps flashing	Stays OFF	
	Outdoor	Keeps flashing	Stays OFF	

1. Applicable model

2. Error detection method

Detection of anomalously low temperature (resistance) of remote control temperature sensor (The)

3. Condition of error displayed

When the temperature sensor detects -50°C or lower for 5 seconds continuously, the compressor stops. After 3-minute delay, the compressor starts again automatically, but if this error occurs again within 60 minutes after the initial detection.

4. Presumable cause

- Faulty connection of remote control temperature sensor
- Defective remote control temperature sensor
- Defective remote control PCB

5. Troubleshooting

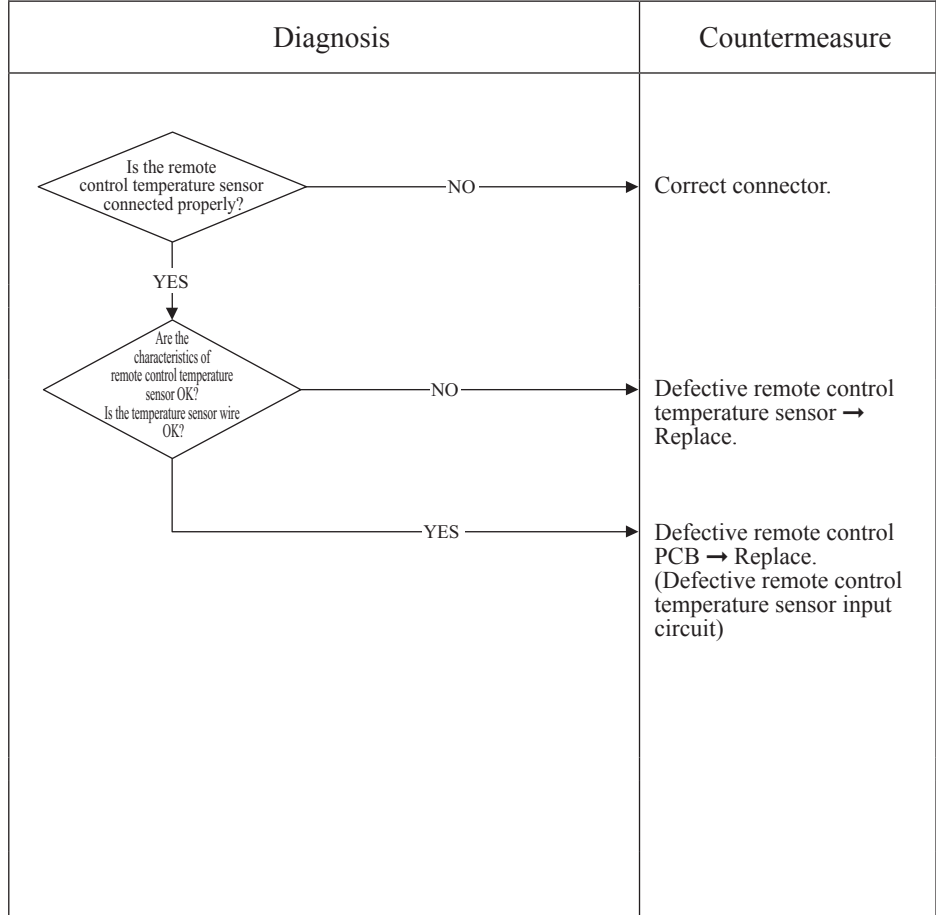

Temperature-resistance characteristics of remote control temperature sensor (The)

Temperature (°C)	Resistance value (kΩ)	Temperature (°C)	Resistance value (kΩ)
0	65	30	16
1	62	32	15
2	59	34	14
4	53	36	13
6	48	38	12
8	44	40	11
10	40	42	9.9
12	36	44	9.2
14	33	46	8.5
16	30	48	7.8
18	27	50	7.3
20	25	52	6.7
22	23	54	6.3
24	21	56	5.8
26	19	58	5.4
28	18	60	5.0

Note: After 10 seconds has passed since remote control temperature sensor was switched from valid to invalid, E28 will not be displayed even if the sensor harness is disconnected. At same time the sensor, which is effective, is switched from remote control temperature sensor to indoor return air temperature sensor. Even though the remote control temperature sensor is set to be Effective, the return air temperature displayed on remote control for checking still shows the value detected by indoor return air temperature sensor, not by remote control temperature sensor.

Error code Remote control: E35	LED	Green	Red	Content Cooling overload operation
	Indoor control PCB	Keeps flashing	Stays OFF	
	Outdoor control PCB	Keeps flashing	1-time flash	
	Outdoor inverter PCB	Yellow LED Keeps flashing		

1. Applicable model

2. Error detection method

For the error detection method, refer to the protective control by controlling compressor rotation speed and cooling high pressure protective control of micro-computer control function for corresponding models.

3. Condition of error displayed

When outdoor heat exchanger temperature anomaly is detected 5 times within 60 minutes or this anomalous state is detected 60 minutes continuously including compressor stop.

- 4. Presumable cause**
- Defective outdoor heat exchanger temperature sensor
 - Defective outdoor unit control (or main) PCB
 - Indoor, outdoor unit installation spaces
 - Short-circuit of air on indoor, outdoor units
 - Fouling, clogging of heat exchanger
 - Excessive refrigerant amount

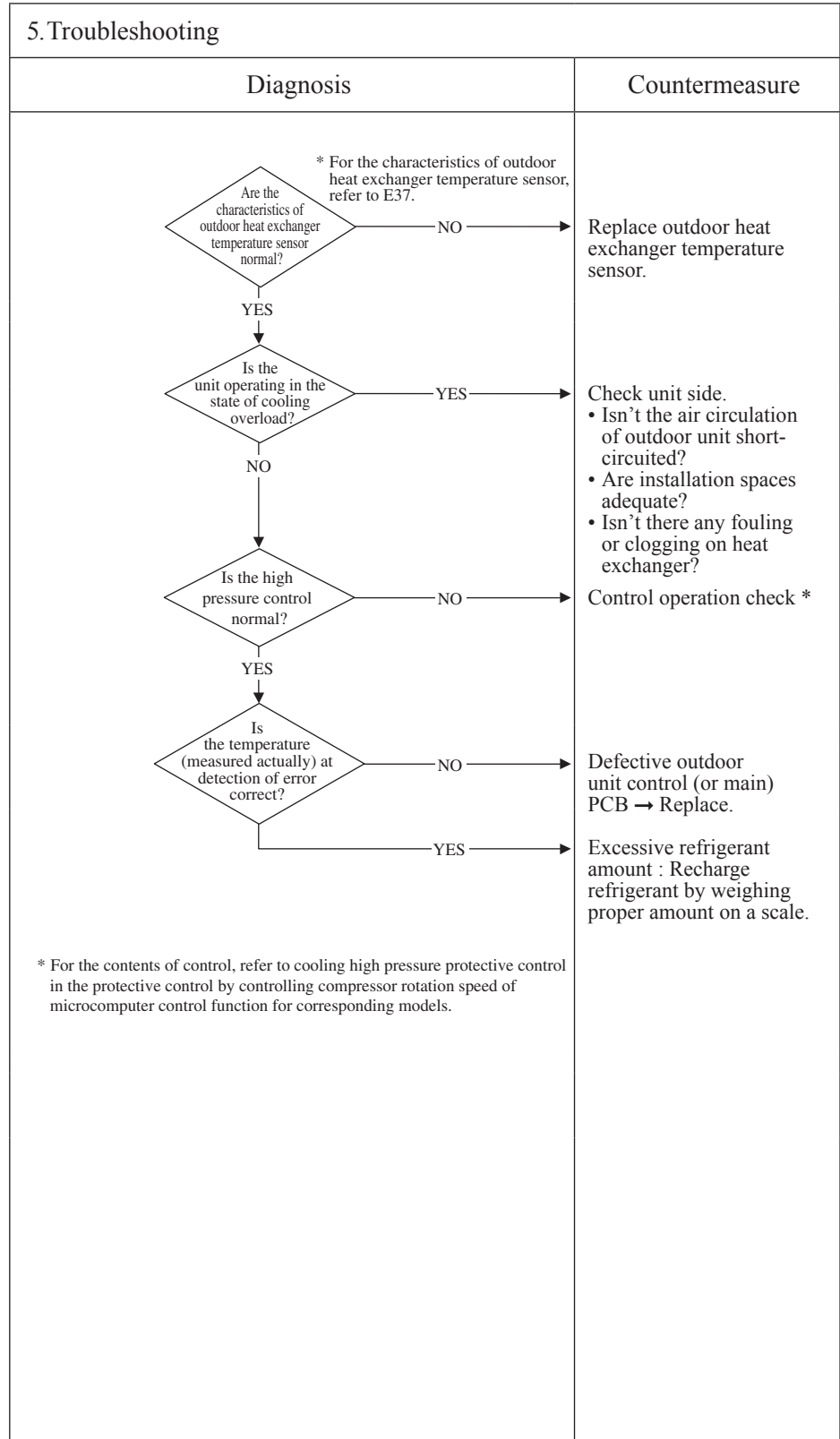

Note:

Error code Remote control: E36	LED	Green	Red	Content Discharge pipe temperature error
	Indoor control PCB	Keeps flashing	Stays OFF	
	Outdoor control PCB	Keeps flashing	1-time flash	
	Outdoor inverter PCB	Yellow LED Keeps flashing		

1.Applicable model

2. Error detection method

For the error detection method, refer to cooling high pressure protective control in the protective control by controlling compressor rotation speed of microcomputer control function for corresponding models.

3. Condition of error displayed

When discharge pipe temperature anomaly is detected 2 times within 60 minutes or this anomalous state is detected 60 minutes continuously including compressor stop.

- 4. Presumable cause**
- Defective outdoor unit control (or main) PCB
 - Defective discharge pipe temperature sensor
 - Clogged filter
 - Indoor, outdoor unit installation spaces
 - Short-circuit of air on indoor, outdoor units
 - Fouling, clogging of heat exchanger

5. Troubleshooting

Diagnosis	Countermeasure
<p>* For the characteristics of discharge pipe temperature sensor, refer to E39.</p> <p>Are the characteristics of discharge pipe temperature sensor normal?</p> <p>NO →</p> <p>YES ↓</p> <p>Is the discharge pipe temperature error persisted during cooling / heating operation?</p> <p>YES →</p> <p>NO ↓</p> <p>Is the discharge pipe temperature control normal?</p> <p>NO →</p> <p>YES ↓</p> <p>Is the temperature (measured actually) at detection of error correct?</p> <p>NO →</p> <p>YES →</p>	<p>Replace discharge pipe temperature sensor.</p> <p>Insufficient refrigerant amount : Recharge refrigerant by weighing proper amount on a scale.</p> <p>Control operation check *</p> <p>Defective outdoor unit control (or main) PCB → Replace.</p> <p>Check unit side:</p> <ul style="list-style-type: none"> • Isn't filter clogged? • Are indoor, outdoor unit installation spaces adequate ? • Isn't there any short-circuit of air? • Isn't there any fouling, clogging on indoor heat exchanger?

* For the contents of control, refer to cooling high pressure protective control in the protective control by controlling compressor rotation speed of microcomputer control function for corresponding models.

Note:

Error code Remote control: E37	LED	Green	Red	Content Outdoor heat exchanger temperature sensor anomaly
	Indoor control PCB	Keeps flashing	Stays OFF	
	Outdoor control PCB	Keeps flashing	1-time flash	
	Outdoor inverter PCB	Yellow LED Keeps flashing		

1. Applicable model

2. Error detection method

Detection of anomalously low temperature (resistance) on the outdoor heat exchanger temperature sensor

3. Condition of error displayed

- When the temperature sensor detects -50°C or lower for 20 seconds continuously within 2 minutes to 2 minutes 20 seconds after the compressor ON, the compressor stops. After 3-minutes delay, the compressor starts again automatically, but if this anomalous temperature is detected 3 times within 40 minutes.
- When -50°C or lower is detected for 5 seconds continuously within 20 seconds after compressor ON.

4. Presumable cause

- Defective outdoor unit control (or main) PCB
- Broken sensor harness or temperature sensing section
- Disconnected wire connection (connector)

5. Troubleshooting

Diagnosis	Countermeasure
<pre> graph TD Q1{Is the outdoor heat exchanger temperature sensor connector connected properly?} Q2{Are the characteristics of outdoor heat exchanger temperature sensor OK?} C1[Correct connector.] C2[Defective outdoor heat exchanger temperature sensor -> Replace.] C3[Defective outdoor unit control (or main) PCB -> Replace. (Defective outdoor heat exchanger temperature sensor input circuit)] Q1 -- NO --> C1 Q1 -- YES --> Q2 Q2 -- NO --> C2 Q2 -- YES --> C3 </pre>	<p>Correct connector.</p> <p>Defective outdoor heat exchanger temperature sensor → Replace.</p> <p>Defective outdoor unit control (or main) PCB → Replace. (Defective outdoor heat exchanger temperature sensor input circuit)</p>

Temperature-resistance characteristics

Temperature (°C)	Temperature sensor resistance (kΩ)
0	15
10	10
20	6
25	5
30	4
40	3
50	2

Note:

Error code Remote control: E38	LED	Green	Red	Content Outdoor air temperature sensor anomaly
	Indoor control PCB	Keeps flashing	Stays OFF	
	Outdoor control PCB	Keeps flashing	1-time flash	
	Outdoor inverter PCB	Yellow LED Keeps flashing		

1. Applicable model

2. Error detection method

Detection of anomalously low temperature (resistance) on outdoor air temperature sensor

3. Condition of error displayed

- When the temperature sensor detects -45°C or lower for 5 seconds continuously within 2 minutes to 2 minutes 20 seconds after the compressor ON, the compressor stops. After 3-minute delay, the compressor starts again automatically, but if this anomalous temperature is detected 3 times within 40 minutes.
- When -45°C or lower is detected for 5 seconds continuously within 20 seconds after compressor ON.

4. Presumable cause

- Defective outdoor unit control (or main) PCB
- Broken sensor harness or temperature sensing section (Check molding.)
- Disconnected wire connection (connector)

5. Troubleshooting

Diagnosis	Countermeasure														
<pre> graph TD Q1{Is the outdoor air temperature sensor connector connected properly?} -- NO --> C1[Correct connector.] Q1 -- YES --> Q2{Is the characteristics of the outdoor air temperature sensor OK?} Q2 -- NO --> C2[Defective outdoor air temperature sensor → Replace.] Q2 -- YES --> C3[Defective outdoor unit control (or main) PCB → Replace. (Defective outdoor air temperature sensor input circuit)] </pre> <p>For the characteristics of outdoor air temperature sensor, see the following graph.</p> <p>• Model FDC71</p> <p>Temperature-resistance characteristics (Broken wire) 35 (Short-circuit) 0</p> <table border="1"> <caption>Temperature-resistance characteristics (Approximate values from graph)</caption> <thead> <tr> <th>Temperature (°C)</th> <th>Temperature sensor resistance (kΩ)</th> </tr> </thead> <tbody> <tr><td>0</td><td>35</td></tr> <tr><td>10</td><td>25</td></tr> <tr><td>20</td><td>18</td></tr> <tr><td>30</td><td>12</td></tr> <tr><td>40</td><td>8</td></tr> <tr><td>50</td><td>5</td></tr> </tbody> </table>	Temperature (°C)	Temperature sensor resistance (kΩ)	0	35	10	25	20	18	30	12	40	8	50	5	<p>Correct connector.</p> <p>Defective outdoor air temperature sensor → Replace.</p> <p>Defective outdoor unit control (or main) PCB → Replace. (Defective outdoor air temperature sensor input circuit)</p>
Temperature (°C)	Temperature sensor resistance (kΩ)														
0	35														
10	25														
20	18														
30	12														
40	8														
50	5														

Note:

Error code Remote control: E39	LED	Green	Red	Content Discharge pipe temperature sensor anomaly
	Indoor control PCB	Keeps flashing	Stays OFF	
	Outdoor control PCB	Keeps flashing	1-time flash	
	Outdoor inverter PCB	Yellow LED Keeps flashing		

1. Applicable model

2. Error detection method

Detection of anomalously low temperature (resistance) on the discharge pipe temperature sensor

3. Condition of error displayed

When the temperature sensor detects -10°C or lower for 5 seconds continuously within 10 minutes to 10 minutes 20 seconds after the compressor ON, the compressor stops. After 3-minute delay, the compressor starts again automatically, but if this anomalous temperature is detected 3 times within 40 minutes.

4. Presumable cause

- Defective outdoor unit control (or main) PCB
- Broken sensor harness or temperature sensing section (Check molding.)
- Disconnected wire connection (connector)

5. Troubleshooting

Diagnosis	Countermeasure
<pre> graph TD Q1{Is the discharge pipe temperature sensor connector connected properly?} -- NO --> C1[Correct connector.] Q1 -- YES --> Q2{Are the characteristics of discharge pipe temperature sensor OK?} Q2 -- NO --> C2[Defective discharge pipe temperature sensor -> Replace.] Q2 -- YES --> C3[Defective outdoor unit control (or main) PCB -> Replace. (Defective discharge pipe temperature sensor input circuit)] </pre> <p>• Model FDC71</p> <p>(Broken wire) Temperature-resistance characteristics</p> <p>(Short-circuit)</p>	<p>Correct connector.</p> <p>Defective discharge pipe temperature sensor → Replace.</p> <p>Defective outdoor unit control (or main) PCB → Replace. (Defective discharge pipe temperature sensor input circuit)</p>

Note:

Error code Remote control: E40	LED	Green	Red	Content High pressure error (63H1 activated)
	Indoor control PCB	Keeps flashing	Stays OFF	
	Outdoor control PCB	Keeps flashing	1-time flash	
	Outdoor inverter PCB	Yellow LED Keeps flashing		

1. Applicable model

2. Error detection method

When the high pressure switch 63H1 is activated.

3. Condition of error displayed

If 63H1 turns OFF (opened), the compressor stops. After 3-minute delay, the compressor restarts. If this anomaly occurs 5 times within 60 minutes or continues for 60 minutes continuously.

4. Presumable cause

- Short-circuit of air flow, disturbance of air flow and clogging filter at outdoor heat exchanger/Breakdown of fan motor
- Defective outdoor unit control (or main) PCB
- Defective 63H1 connector
- Defective electronic expansion valve connector
- Closed service valve
- Mixing of non-condensing gas (nitrogen, etc.)

5. Troubleshooting

Diagnosis	Countermeasure
<p>If the power source breaker is turned OFF and ON too quickly, E40 may be displayed. (This is normal.)</p> <p>Is the service valve fully opened?</p> <p>NO → Open the service valve.</p> <p>YES → Has 63H1 activated?</p> <p>NO → Is 63H1 connector connected properly?</p> <p>NO → Correct 63H1 connector.</p> <p>YES → Is the electronic expansion valve connector connection OK?</p> <p>NO → Correct electronic expansion valve connector.</p> <p>YES → Defective outdoor unit control (or main) PCB → Replace. (Defective 63H1 input circuit)</p> <p>If any anomaly exists on the electronic expansion valve connector connection, the power source must be reset.</p> <p>On operation of 63H1</p> <p>1. During cooling</p> <ul style="list-style-type: none"> • Is the outdoor fan motor running? • Isn't any short-circuit of air on the outdoor unit? • Are sufficient return air/supply air space secured? <p>2. During heating</p> <ul style="list-style-type: none"> • Isn't the indoor heat exchanger temperature sensor disconnected from the sensor casing? • Isn't the filter clogged? <p>* Under the condition of overcharging refrigerant, 63H1 may activate due to delay of starting the preventive control by compressor speed control, because detected heat exchanger temperature, which conducts compressor speed control, becomes lower than normal condition due to excess sub-cooling degree.</p>	

Note: In the protective control range for compressor startup (initial startup after power ON), even if 63H1 is activated only once (63H1 turns OFF), immediately the error is displayed.

Error code Remote control: E41	LED	Green	Red	Content Power transistor overheat
	Indoor control PCB	Keeps flashing	Stays OFF	
	Outdoor control PCB	Keeps flashing	1-time flash	
	Outdoor inverter PCB	Yellow LED 6-time flash		

1.Applicable model

2.Error detection method

When less than DC14V of the output voltage is detected between ② and ③ on CNI3, E41 is displayed.
(See "Note" mentioned below.)

3.Condition of error displayed

Seme as above.

4.Presumable cause

- Inverter PCB anomaly
- Outdoor fan motor anomaly
- Outdoor unit control PCB anomaly
- Noise filter PCB anomaly

5.Troubleshooting

Diagnosis	Countermeasure
<pre> graph TD D1{Is DC15V detected between ② and ③ on CNI3? (1)(2)} D2{Is DC15V detected after disconnecting outdoor fan motor? (1)} D1 -- YES --> C1[Replace inverter PCB . If not solved, replace noise filter PCB as well.] D1 -- NO --> N1[Note(1) Under anomalous conditions, the voltage becomes less than DC14V.] N1 --> D2 D2 -- YES --> C2[Replace outdoor fan motor.] D2 -- NO --> C3[Replace outdoor unit control PCB . If not solved, replace inverter PCB as well.] style N1 fill:none,stroke:none </pre> <p>Note(2) How to check the voltage between ② and ③ of CNI3? =>See E51</p>	<p>Replace inverter PCB . If not solved, replace noise filter PCB as well.</p> <p>Replace outdoor fan motor.</p> <p>Replace outdoor unit control PCB . If not solved, replace inverter PCB as well.</p>

Note: The "Single phase models" of inverter PAC have no function to output the signal for the power transistor overheat. However since the power source for the power transistor and the outdoor fan motor is in the same line, when the anomaly of the outdoor fan motor occurs, E41 is displayed.

Error code Remote control: E42	LED	Green	Red	Content Current cut (1/2)
	Indoor control PCB	Keeps flashing	Stays OFF	
	Outdoor control PCB	Keeps flashing	1-time flash	
	Outdoor inverter PCB	Yellow LED 1-time flash		

1. Applicable model

2. Error detection method

In order to prevent from overcurrent of inverter, if the current exceeds the specifications, it makes the compressor stopping.

3. Condition of error displayed

- If the output current of inverter exceeds the specifications, it makes the compressor stopping.
- After 3-minute delay, the compressor restarts, but if this anomaly occurs 4 times within 30 minutes after the initial detection.

4. Presumable cause

- The service valves closed
- Faulty power source
- Insufficient refrigerant amount
- Faulty compressor
- Faulty power transistor module

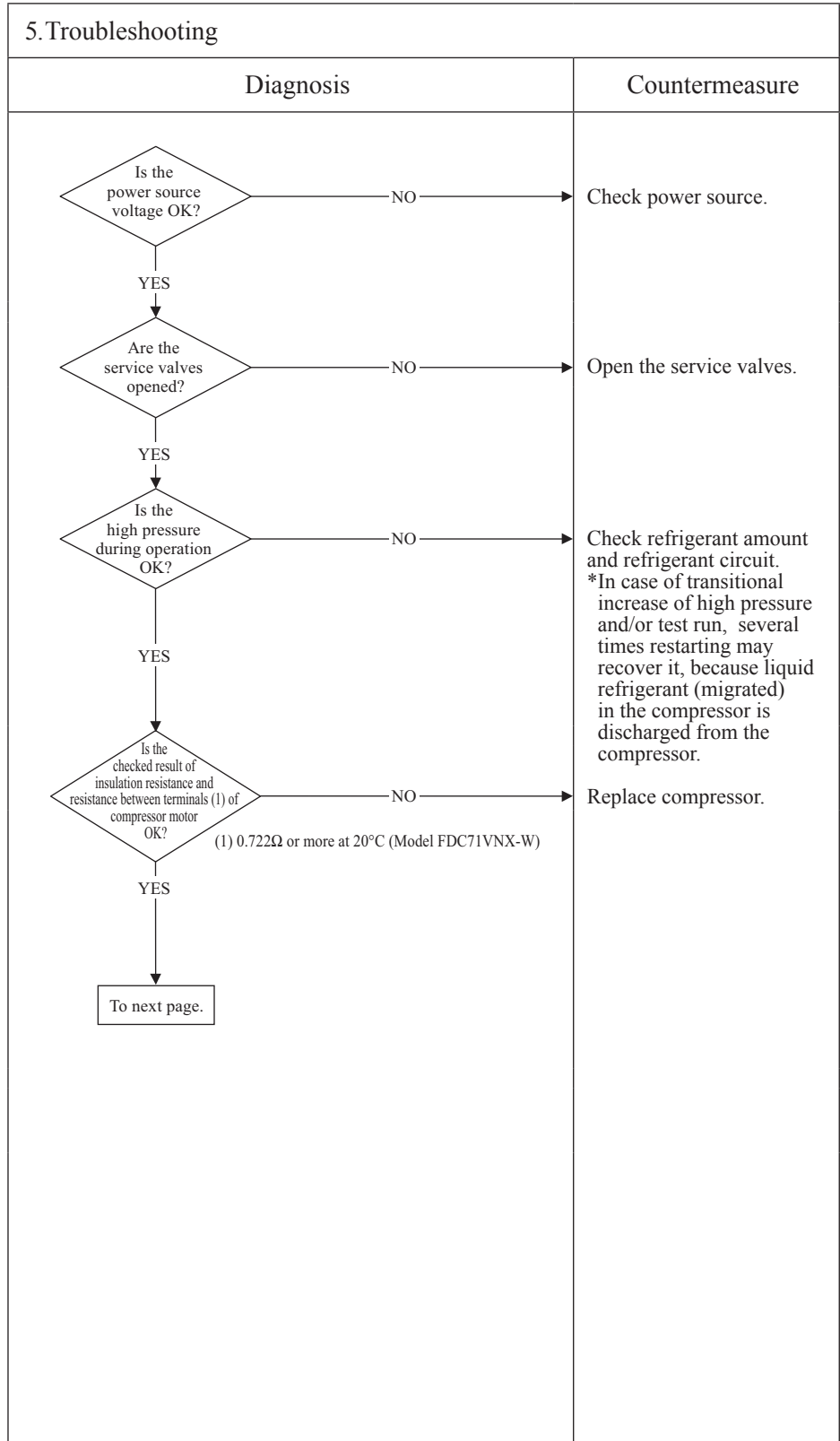

Note:

Error code Remote control: E42	LED	Green	Red	Content Current cut (2/2)
	Indoor	Keeps flashing	Stays OFF	
	Outdoor control PCB	Keeps flashing	1-time flash	
	Outdoor inverter PCB	Yellow LED 1-time flash		

1. Applicable model

2. Error detection method

In order to prevent from overcurrent of inverter, if the current exceeds the specifications, it makes the compressor stopping.

3. Condition of error displayed

- If the output current of inverter exceeds the specifications, it makes the compressor stopping.
- After 3-minute delay, the compressor restarts, but if this anomaly occurs 4 times within 30 minutes after the initial detection.

4. Presumable cause

- Defective inverter (or outdoor unit main) PCB
- Faulty power source
- Insufficient refrigerant amount
- Faulty compressor
- Faulty power transistor module

5. Troubleshooting

Diagnosis	Countermeasure
<p>From previous page</p> <p>Is the checked result of power transistor module OK?</p> <p>NO → Defective inverter (or outdoor unit main) PCB → Replace.</p> <p>YES</p> <div style="border: 1px dashed black; padding: 5px;"> <ul style="list-style-type: none"> • Is the space for installation of indoor and/or outdoor unit enough? • Is there any short-circuit of air on indoor and/or outdoor unit? • At cooling, does the outdoor fan motor run? Are the service valves fully opened? Is the filter clogged? • At heating, does the indoor fan motor run? Are the service valves fully opened? Is the filter clogged? • Is there any liquid flooding? Is the superheat within normal range? • Is the low pressure sensor and suction pipe temperature sensor normal? • Is there any anomalous sound on the compressor? </div> <p>YES</p> <p>After resetting power for several times does it become normal?</p> <p>NO → Defective inverter (or outdoor unit main) PCB → Replace.</p> <p>YES</p> <p>Temporary noise may cause of anomaly. If noise source can be found, take countermeasure.</p>	

Note:

Error code Remote control: E45	LED	Green	Red	Content Communication error between inverter PCB and outdoor unit control PCB
	Indoor control PCB	Keeps flashing	Stays OFF	
	Outdoor control PCB	Keeps flashing	1-time flash	
	Outdoor inverter PCB	Yellow LED Keeps flashing		

1. Applicable model

2. Error detection method

When the communication between inverter PCB and outdoor unit control PCB is not established.

3. Condition of error displayed

Same as above.

4. Presumable cause

- Inverter PCB anomaly
- Anomalous connection of connector between the outdoor unit control PCB and inverter PCB
- Outdoor unit control PCB anomaly
- Outdoor fan motor anomaly

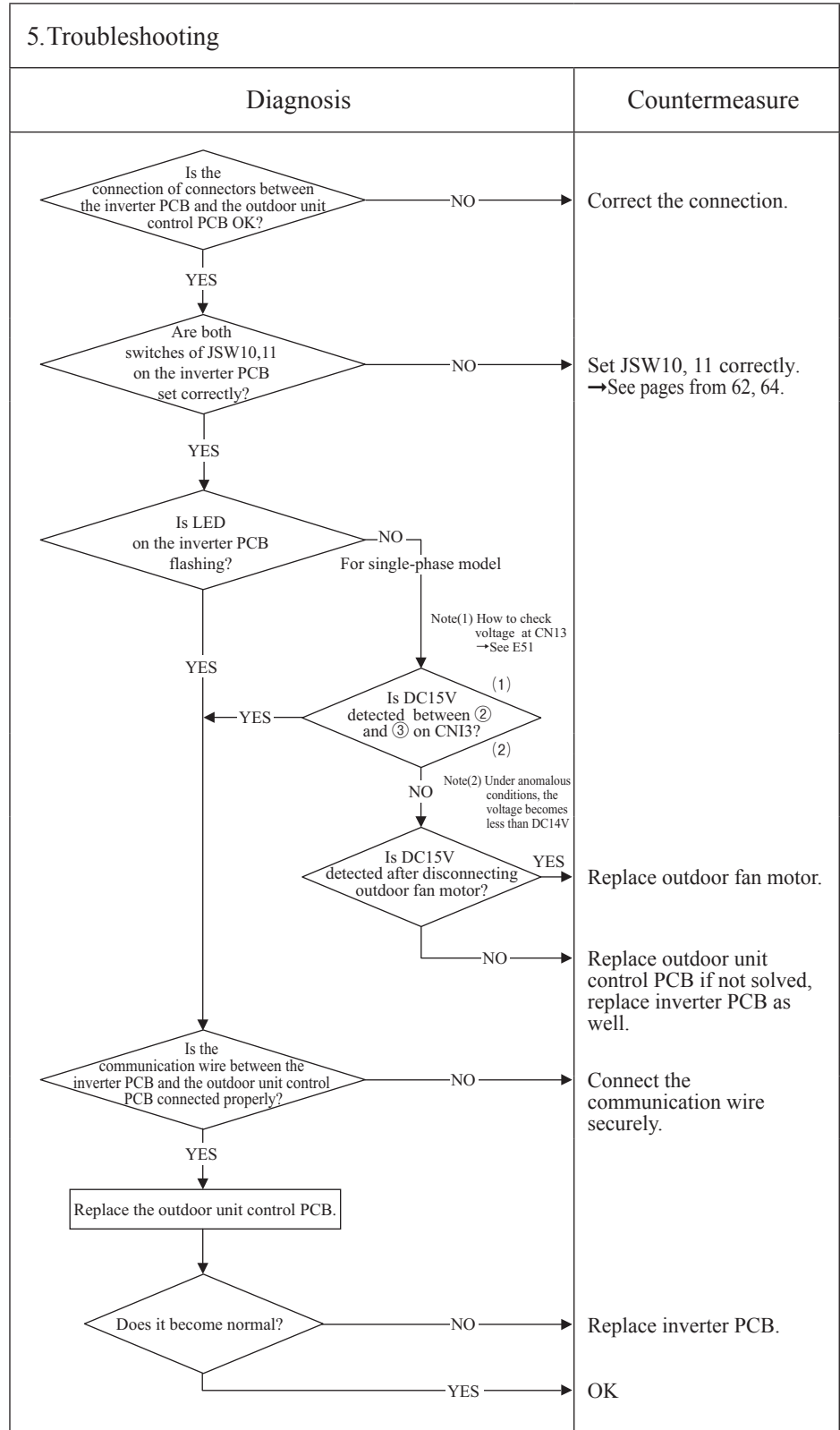

Note:

Error code Remote control: E47	LED	Green	Red	Content Inverter PCB A/F module anomaly
	Indoor	Keeps flashing	Stays off	
	Outdoor control PCB	Keeps flashing	1-time flash	
	Outdoor inverter PCB	Yellow LED 7-time flashing		

1.Applicable model

2.Error detection method

In order to prevent from overcurrent of A/F, if the current exceeds the specifications, it makes the compressor stopping.

3.Condition of error displayed

- If the output current of A/F exceeds the specifications, it makes the compressor stopping.

4.Presumable cause

- Defective inverter PCB

5.Troubleshooting

Diagnosis	Countermeasure
<pre> graph TD A{Is the power source voltage OK?} -- NO --> B[Check power source.] A -- YES --> C{Is the checked results of insulation resistance and resistance between terminals (1) of compressor motor OK?} C -- NO --> D[Replace compressor.] C -- YES --> E[Defective outdoor inverter PCB → Replace.] </pre>	

Note:

Error code Remote control: E48	LED	Green	Red	Content Outdoor fan motor anomaly
	Indoor control PCB	Keeps flashing	Stays OFF	
	Outdoor control PCB	Keeps flashing	1-time flash	
	Outdoor inverter PCB	Yellow LED Keeps flashing		

1. Applicable model

2. Error detection method
Detected by rotation speed of outdoor fan motor

3. Condition of error displayed
When actual rotation speed of outdoor fan motor (FMo1) drops to 100min⁻¹ or lower for 30 minutes continuously, the compressor and the outdoor fan motor stop. After 3-minute delay, it starts again automatically, but if this anomaly occurs 5 times within 60 minutes after the initial detection.

- 4. Presumable cause**
- Defective outdoor unit control PCB
 - Foreign material at rotational area of fan propeller
 - Defective fan motor
 - Dust on outdoor unit control PCB
 - Blow fuse
 - External noise, surge

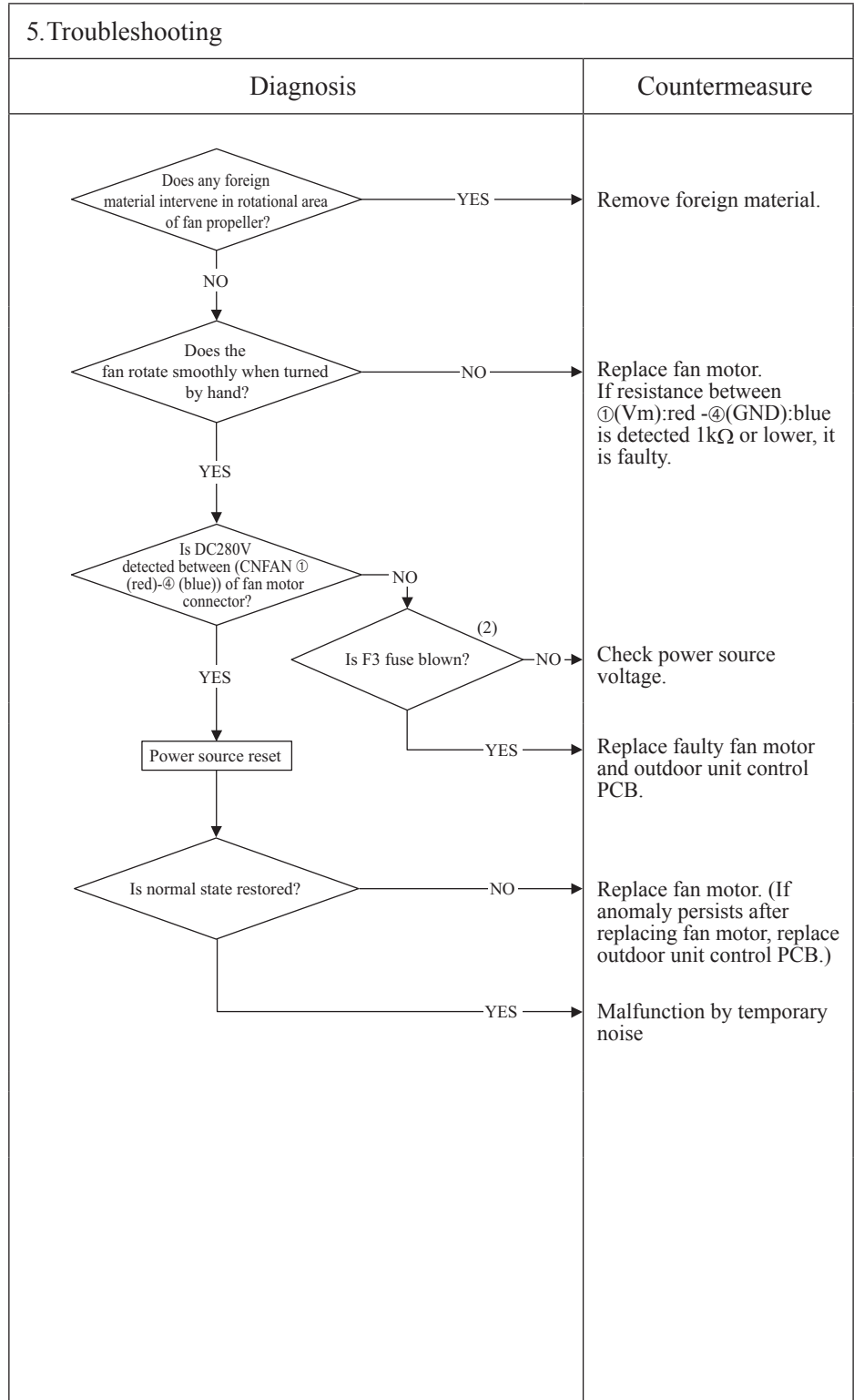

Note: When E48 error occurs, in almost cases F3 fuse (2A) on the outdoor unit control PCB is blown. There are a lot of cases that fuse is blown and E48 occurs due to defective fan motor. And even though only the outdoor unit control PCB (or fuse) is replaced, another trouble (*1) could occur. Therefore when fuse is blown, check whether the fan motor is OK or not.
After confirming the fan motor normal, check by power ON. (Don't power ON without confirming the fan motor normal.)
*1 The error which does not seem to relate E48 may occur like as “WAIT”, Stay OFF of LED on outdoor unit control PCB, inverter communication error (E45) and etc.

Error code Remote control: E49	LED	Green	Red	Content Low pressure error or low pressure sensor anomaly (1/2)
	Indoor control PCB	Keeps flashing	Stays OFF	
	Outdoor control PCB	Keeps flashing	1-time flash	
	Outdoor inverter PCB	Yellow LED Keeps flashing		

1. Applicable model

2. Error detection method
Detected by low pressure drop and suction superheat

3. Condition of error displayed

- ① When the low pressure sensor detects 0.079MPa or lower for 15 seconds continuously, compressor stops and it restarts automatically after 3-minute delay. And if this anomaly occurs 3 times within 60 minutes.
- ② 10 minutes after the compressor starts, if the low pressure sensor detects 0.15MPa or lower for 60 minutes continuously and compressor suction superheat is detected 30degC or higher for 60 minutes continuously. And if this anomaly occurs 3 times within 60 minutes.
- ③ If low pressure sensor detects 0.079MPa or lower for 5 minutes continuously (including the compressor stop status).

4. Presumable cause

- Defective outdoor unit control PCB
- Defective low pressure sensor connector
- Defective low pressure sensor
- Defective suction pipe temperature sensor connector
- Defective suction pipe temperature sensor

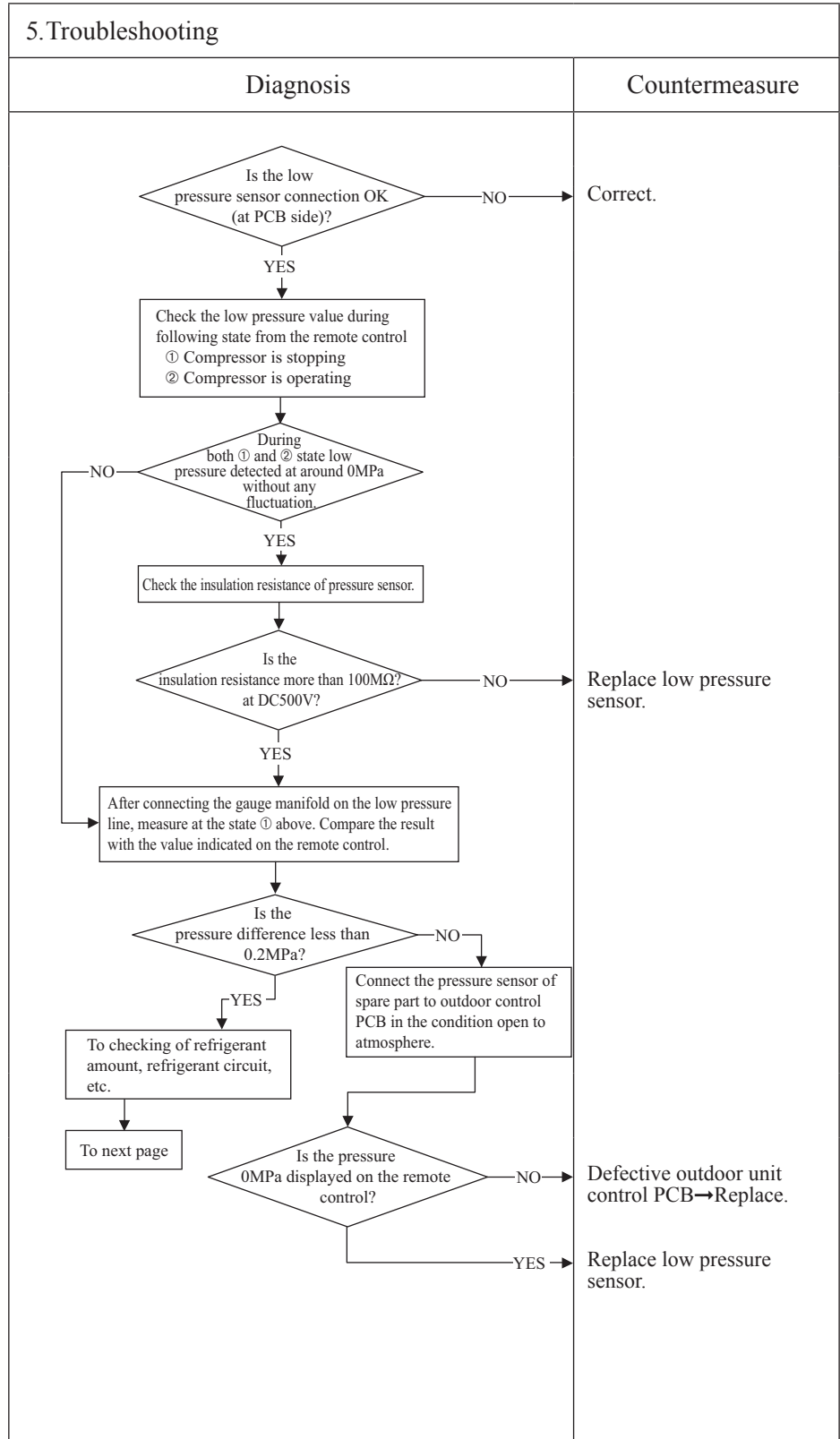

Note: * Connect the gauge manifold to the service valve check joint during cooling, or connect it to the check joint at internal piping of outdoor unit during heating.

Error code Remote control: E49	LED	Green	Red	Content Low pressure error or low pressure sensor anomaly (2/2)
	Indoor control PCB	Keeps flashing	Stays OFF	
	Outdoor control PCB	Keeps flashing	1-time flash	
	Outdoor inverter PCB	Yellow LED Keeps flashing		

1.Applicable model

2.Error detection method

3.Condition of error displayed

4.Presumable cause

5.Troubleshooting	
Diagnosis	Countermeasure
<pre> graph TD Start[From previous page] --> D1{Is the service valve fully opened?} D1 -- NO --> C1[Open fully.] D1 -- YES --> D2{Are the connections of low pressure sensor and suction pipe temperature sensor connector OK?} D2 -- NO --> C2[Correct.] D2 -- YES --> D3{Are the characteristics of low pressure sensor, suction pipe temperature sensor OK?} D3 -- NO --> C3["Defective low pressure sensor, suction pipe temperature sensor -> Replace."] D3 -- YES --> D4{Is the low pressure normal during operation?} D4 -- NO --> C4[Charge refrigerant.] D4 -- YES --> C5["Defective outdoor unit control PCB -> Replace. (Defective low pressure sensor, suction pipe temperature sensor circuits)"] </pre>	

Note:

Error code Remote control: E51	LED	Green	Red	Content Inverter and fan motor anomaly
	Indoor control PCB	Keeps flashing	Stays OFF	
	Outdoor control PCB	Keeps flashing	1-time flash	
	Outdoor inverter PCB	Yellow LED 6-time flash		

<p>1.Applicable model</p>	<p>5.Troubleshooting</p> <table border="1" style="width: 100%;"> <thead> <tr> <th style="width: 50%;">Diagnosis</th> <th style="width: 50%;">Countermeasure</th> </tr> </thead> <tbody> <tr> <td style="text-align: center;"> <pre> graph TD Q1{Is DC15V detected between ② and ③ on CNI3? (1)(2)} Q2{Is DC15V detected after disconnecting outdoor fan motor? (1)} C1[Replace inverter PCB. If not solved, replace noise filter PCB as well.] C2[Replace outdoor fan motor.] C3[Replace outdoor unit control PCB. If not solved, replace inverter PCB as well.] Q1 -- YES --> C1 Q1 -- NO --> Note[Note(1) Under anomalous conditions, the voltage becomes less than DC14V.] Note --> Q2 Q2 -- YES --> C2 Q2 -- NO --> C3 </pre> </td> <td></td> </tr> </tbody> </table>		Diagnosis	Countermeasure	<pre> graph TD Q1{Is DC15V detected between ② and ③ on CNI3? (1)(2)} Q2{Is DC15V detected after disconnecting outdoor fan motor? (1)} C1[Replace inverter PCB. If not solved, replace noise filter PCB as well.] C2[Replace outdoor fan motor.] C3[Replace outdoor unit control PCB. If not solved, replace inverter PCB as well.] Q1 -- YES --> C1 Q1 -- NO --> Note[Note(1) Under anomalous conditions, the voltage becomes less than DC14V.] Note --> Q2 Q2 -- YES --> C2 Q2 -- NO --> C3 </pre>	
Diagnosis	Countermeasure					
<pre> graph TD Q1{Is DC15V detected between ② and ③ on CNI3? (1)(2)} Q2{Is DC15V detected after disconnecting outdoor fan motor? (1)} C1[Replace inverter PCB. If not solved, replace noise filter PCB as well.] C2[Replace outdoor fan motor.] C3[Replace outdoor unit control PCB. If not solved, replace inverter PCB as well.] Q1 -- YES --> C1 Q1 -- NO --> Note[Note(1) Under anomalous conditions, the voltage becomes less than DC14V.] Note --> Q2 Q2 -- YES --> C2 Q2 -- NO --> C3 </pre>						
<p>2.Error detection method</p> <p>When power transistor anomaly is detected for 15 minutes continuously</p>						
<p>3.Condition of error displayed</p> <p>Same as above</p>						
<p>4.Presumable cause</p> <ul style="list-style-type: none"> • Outdoor fan motor anomaly • Inverter PCB anomaly • Outdoor unit control (or main) PCB anomaly 						

Note:

Error code Remote control: E53	LED	Green	Red	Content <h2 style="text-align: center;">Suction pipe temperature sensor anomaly</h2>
	Indoor control PCB	Keeps flashing	Stays OFF	
	Outdoor control PCB	Keeps flashing	1-time flash	
	Outdoor inverter PCB	Yellow LED Keeps flashing		

1.Applicable model

2.Error detection method

When the suction pipe temperature sensor detects anomalously low temperature

3.Condition of error displayed

If the temperature sensor detects -50°C or lower for 5 seconds continuously within 10 minutes to 10 minutes 20 seconds after compressor ON, the compressor stops. When the compressor is restarted automatically after 3-minute delay, if this anomaly occurs 3 times within 40 minutes.

4.Presumable cause

- Defective suction pipe temperature sensor connection
- Defective suction pipe temperature sensor
- Defective outdoor unit control (or main) PCB

5.Troubleshooting

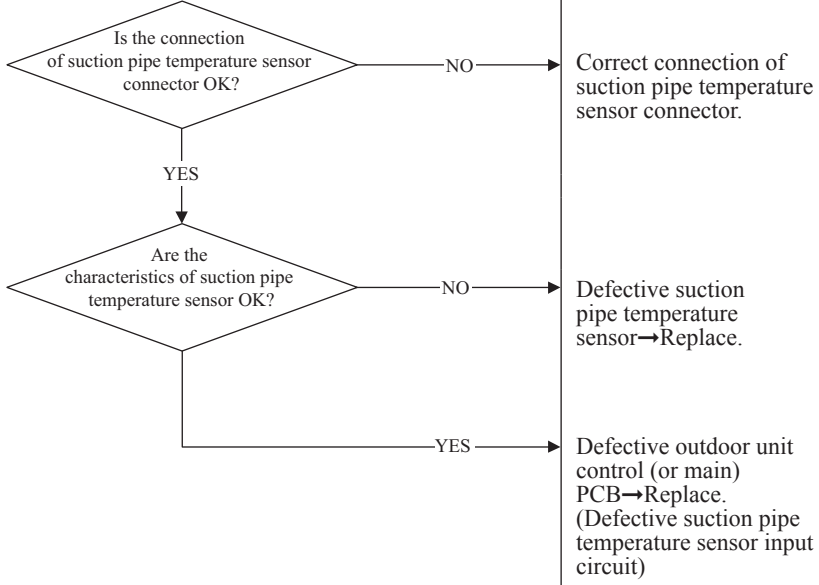
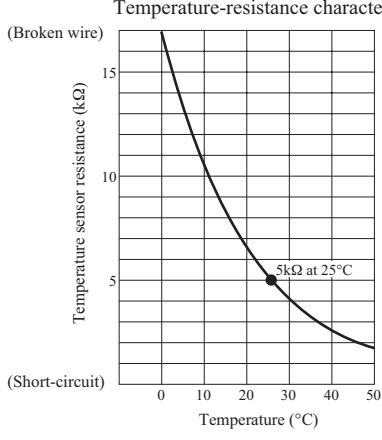
Diagnosis	Countermeasure																
 <pre> graph TD Q1{Is the connection of suction pipe temperature sensor connector OK?} Q2{Are the characteristics of suction pipe temperature sensor OK?} C1[Correct connection of suction pipe temperature sensor connector.] C2[Defective suction pipe temperature sensor -> Replace.] C3[Defective outdoor unit control (or main) PCB -> Replace. (Defective suction pipe temperature sensor input circuit)] Q1 -- NO --> C1 Q1 -- YES --> Q2 Q2 -- NO --> C2 Q2 -- YES --> C3 </pre>																	
<p>Temperature-resistance characteristics</p>  <table border="1"> <caption>Temperature-resistance characteristics data points (approximate)</caption> <thead> <tr> <th>Temperature (°C)</th> <th>Temperature sensor resistance (kΩ)</th> </tr> </thead> <tbody> <tr><td>0</td><td>15</td></tr> <tr><td>10</td><td>10</td></tr> <tr><td>20</td><td>7</td></tr> <tr><td>25</td><td>5</td></tr> <tr><td>30</td><td>4</td></tr> <tr><td>40</td><td>3</td></tr> <tr><td>50</td><td>2</td></tr> </tbody> </table>	Temperature (°C)	Temperature sensor resistance (kΩ)	0	15	10	10	20	7	25	5	30	4	40	3	50	2	
Temperature (°C)	Temperature sensor resistance (kΩ)																
0	15																
10	10																
20	7																
25	5																
30	4																
40	3																
50	2																

Note:

Error code Remote control: E54	LED	Green	Red	Content Low pressure sensor anomaly
	Indoor control PCB	Keeps flashing	Stays OFF	
	Outdoor control PCB	Keeps flashing	1-time flash	
	Outdoor inverter PCB	Yellow LED Keeps flashing		

1. Applicable model

2. Error detection method

When anomalous voltage (pressure) is detected

3. Condition of error displayed

If the pressure sensor detects DC0V or lower and DC4.0V or higher for 5 seconds continuously within 2 minutes to 2 minutes 20 seconds after compressor ON, the compressor stops. When the compressor is restarted automatically after 3-minute delay, if this anomaly occurs 3 times within 40 minutes.

- 4. Presumable cause**
- Defective low pressure sensor connection
 - Defective low pressure sensor
 - Defective outdoor unit control PCB
 - Improper amount of refrigerant
 - Anomalous refrigeration circuit

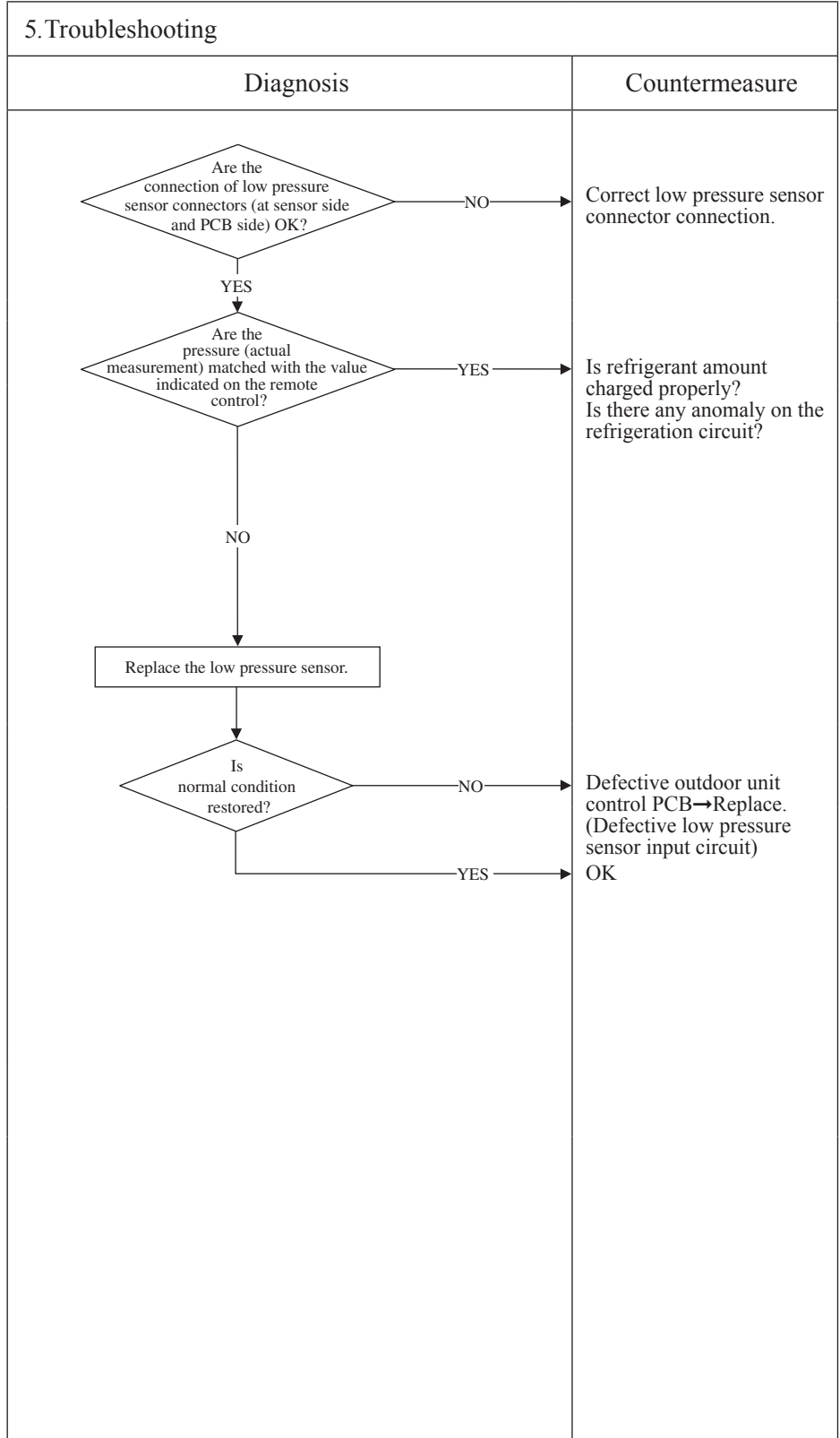

Note:

Error code Remote control: E57	LED	Green	Red	Content Insufficient refrigerant amount or detection of service valve closure
	Indoor control PCB	Keeps flashing	Stays OFF	
	Outdoor control PCB	Keeps flashing	1-time flash	
	Outdoor inverter PCB	Yellow LED Keeps flashing		

1. Applicable model

2. Error detection method

- Judge insufficient refrigerant amount by detecting the temperature difference between indoor heat exchanger (Thi-R) and indoor return air (Thi-A).

3. Condition of error displayed

Anomalous stop at initial detection

4. Presumable cause

- Defective indoor heat exchanger temperature sensor
- Defective indoor return air temperature sensor
- Defective indoor unit control (or main) PCB
- Insufficient refrigerant amount

5. Troubleshooting

Diagnosis	Countermeasure
<p>Is the service valve fully opened?</p> <p>NO →</p> <p>YES ↓</p> <p>Are the connections of indoor heat exchanger and/or return air temperature sensor connectors OK?</p> <p>NO →</p> <p>YES ↓</p> <p>Are the characteristics of indoor heat exchanger and/or return air temperature sensor OK?</p> <p>NO →</p> <p>YES ↓</p> <p>Is the low pressure during operation normal?</p> <p>NO →</p> <p>YES →</p>	<p>Open fully.</p> <p>Correct indoor heat exchanger, return air temperature sensor connector connections.</p> <p>Defective indoor heat exchanger, return air temperature sensor → Replace.</p> <p>Charge refrigerant.</p> <p>Defective indoor unit control (or main) PCB → Replace. (Defective indoor heat exchanger, return air temperature sensor input circuits)</p>

Indoor heat exchanger, return air temperature sensor
Temperature-resistance characteristics

(Broken wire)

(Short-circuit)

Note: Insufficient refrigerant amount preventive control makes compressor stopped, if it judges insufficient refrigerant amount by detecting the temperature difference between indoor heat exchanger (Thi-R) and return air temperature (Thi-A) for 1 minute after compressor ON in cooling or dehumidifying mode and for 9 minutes after compressor ON in heating mode. [in cooling mode: (Thi-A)-(Thi-R) ≤ 4degC, in heating mode: (Thi-R)-(Thi-A) ≤ 4degC]

Error code Remote control: E59	LED	Green	Red	Content Compressor startup failure (1/2)
	Indoor control PCB	Keeps flashing	Stays OFF	
	Outdoor control PCB	Keeps flashing	5-time flash	
	Outdoor inverter PCB	Yellow LED Stays OFF		

1. Applicable model

2. Error detection method
When it fails to change over to the operation for rotor position detection of compressor motor

3. Condition of error displayed
If the compressor fails to startup for 20 times (10 patterns × 2 times) continuously.

4. Presumable cause

- Outdoor fan motor anomaly
- Outdoor unit control PCB anomaly
- Inverter PCB anomaly
- Anomalous power source voltage
- Insufficient or excessive refrigerant amount
- Faulty component for refrigerant circuit
- Compressor anomaly (Motor or bearing)

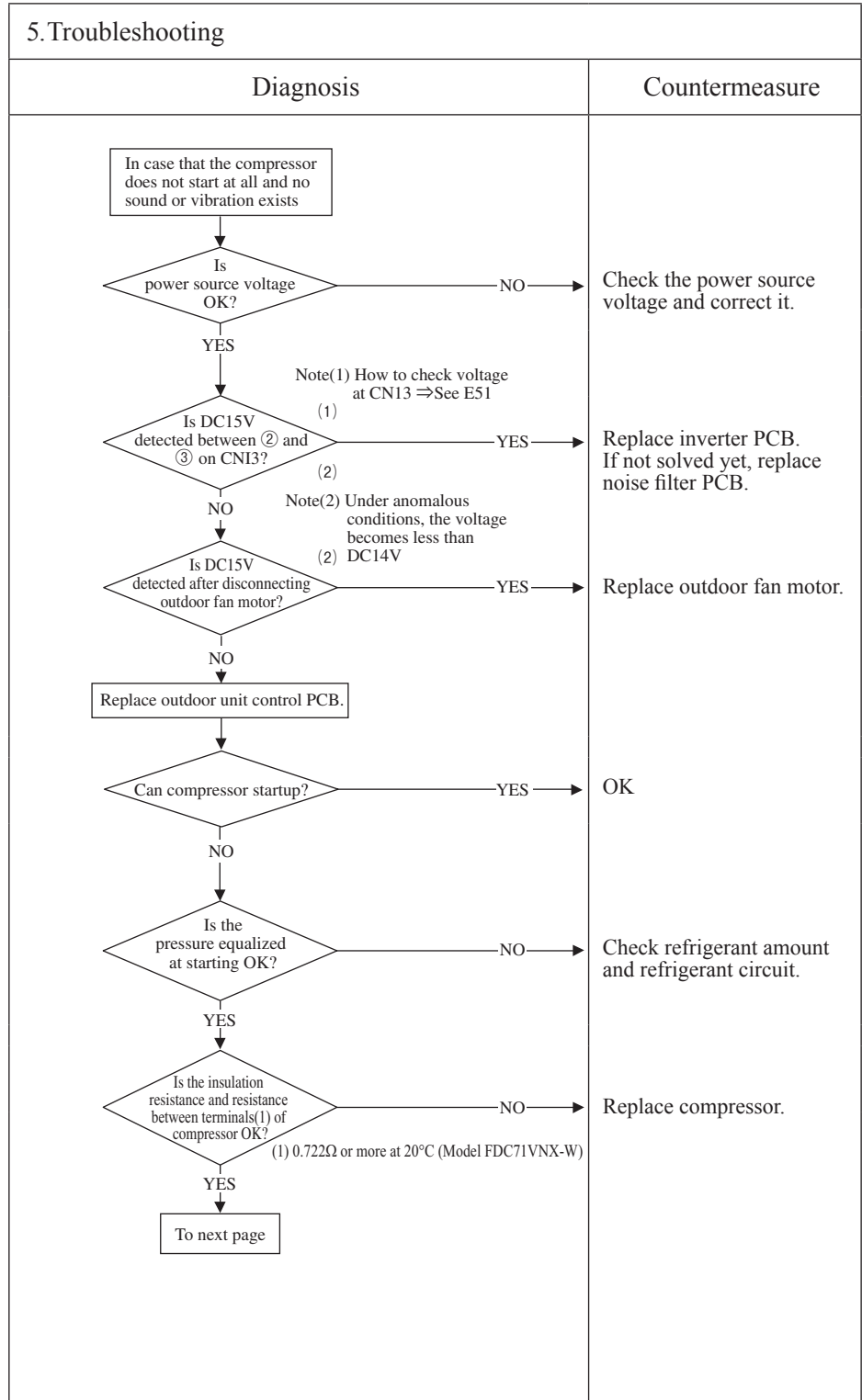

Note: Insulation resistance

- The unit is left for long period without power source or soon after installation, insulation resistance may decrease to several MΩ or lower due to the liquid refrigerant migrated in the refrigerant oil in compressor. If the electric leakage breaker is activated due to low insulation resistance, check followings.
 - ① Check whether the insulation resistance can recover or not, after 6 hours has passed since power ON. (By energize the crankcase heater, liquid refrigerant migrated in the refrigerant oil in compressor can be evaporated)
 - ② Check whether the electric leakage breaker conforms to high-harmonic specifications. (As inverter PAC units has inverter, in order to prevent from improper operation, be sure to use the breaker of high-harmonic type)

Error code Remote control: E59	LED	Green	Red	Content Compressor startup failure (2/2)
	Indoor control PCB	Keeps flashing	Stays OFF	
	Outdoor control PCB	Keeps flashing	5-time flash	
	Outdoor inverter PCB	Yellow LED Stays OFF		

1. Applicable model

2. Error detection method

3. Condition of error displayed

4. Presumable cause

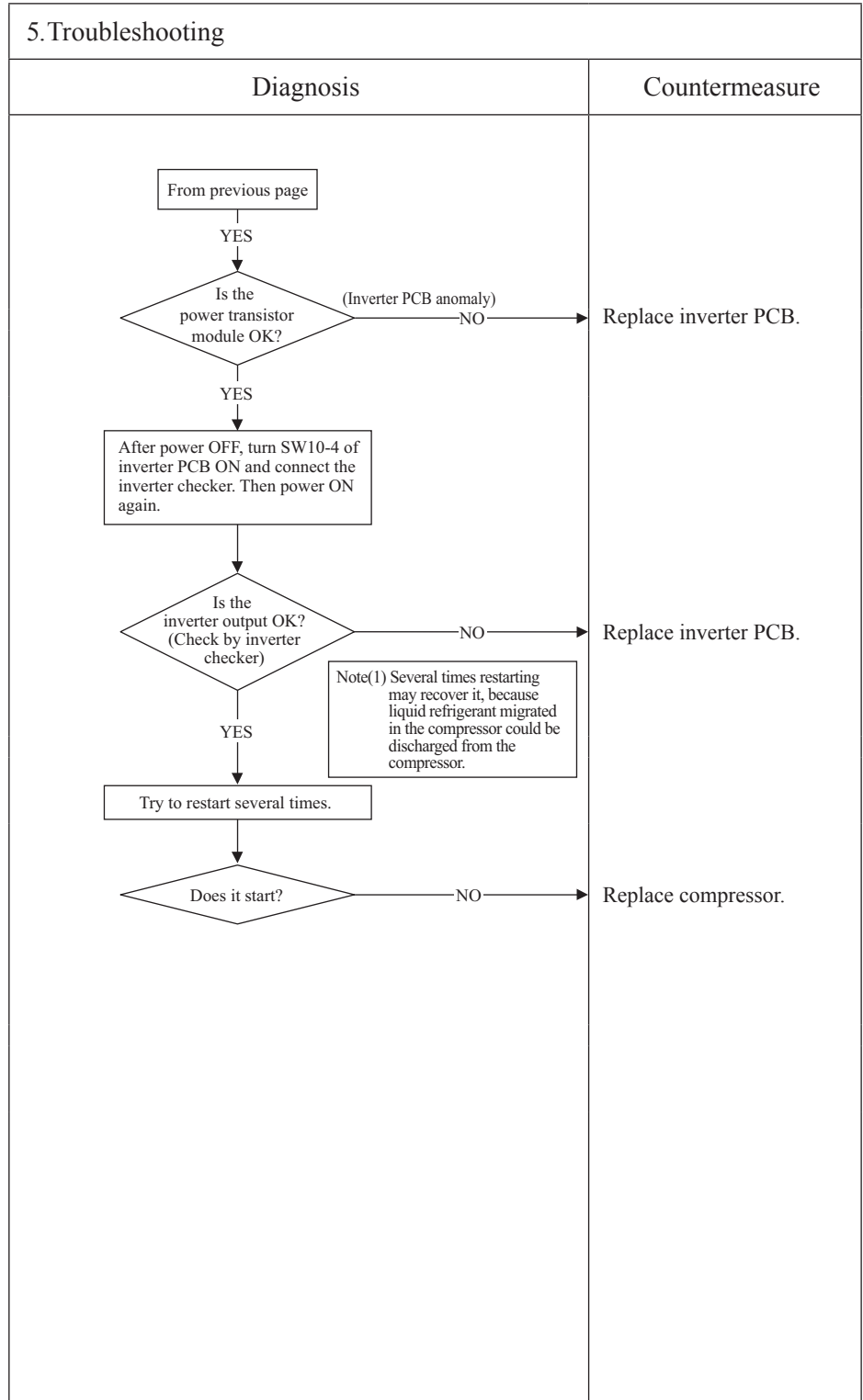

Note:

1.2.2 SRK series

This chapter has described about an indoor unit. Look at 1.2.1 chapters about the outdoor unit.

(1) Cautions

- (a) If you are disassembling and checking an air-conditioner, be sure to turn off the power before beginning. When working on indoor units, let the unit sit for about 1 minute after turning off the power before you begin work.
- (b) When taking out printed circuit boards, be sure to do so without exerting force on the circuit boards or package components.
- (c) When disconnecting and connecting connectors, take hold of the connector housing and do not pull on the lead wires.

(2) Items to check before troubleshooting

- (a) Have you thoroughly investigated the details of the trouble which the customer is complaining about?
- (b) Is the air-conditioner running? Is it displaying any self-diagnosis information?
- (c) Is a power source with the correct voltage connected?
- (d) Are the control lines connecting the indoor and outdoor units wired correctly and connected securely?
- (e) Is the outdoor unit's service valve open?

(3) Troubleshooting procedure (If the air-conditioner does not run at all)

If the air-conditioner does not run at all, diagnose the trouble using the following troubleshooting procedure. If the air-conditioner is running but breaks down, proceed to troubleshooting step (4).

Important When all the following conditions are satisfied, we say that the air-conditioner will not run at all.

- (a) The RUN light does not light up.
- (b) The flaps do not open.
- (c) The indoor unit fan motors do not run.
- (d) The self-diagnosis display does not function.

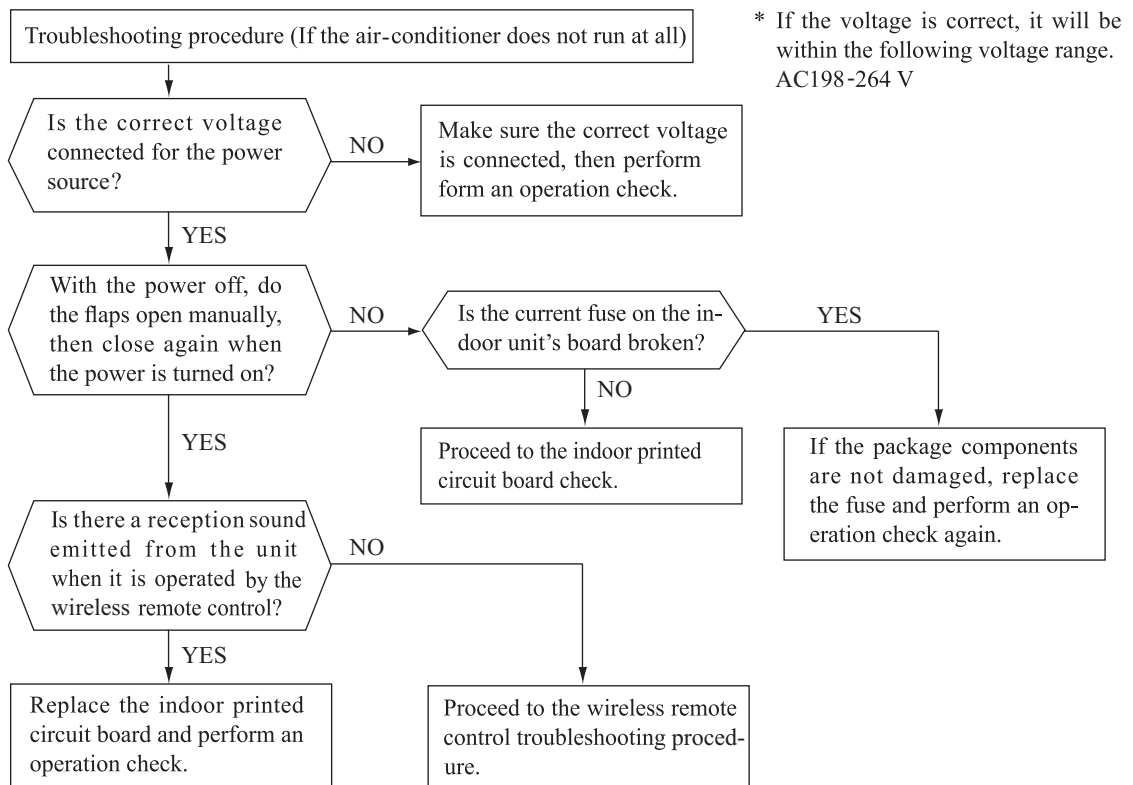

(4) Troubleshooting procedure (If the air-conditioner runs)

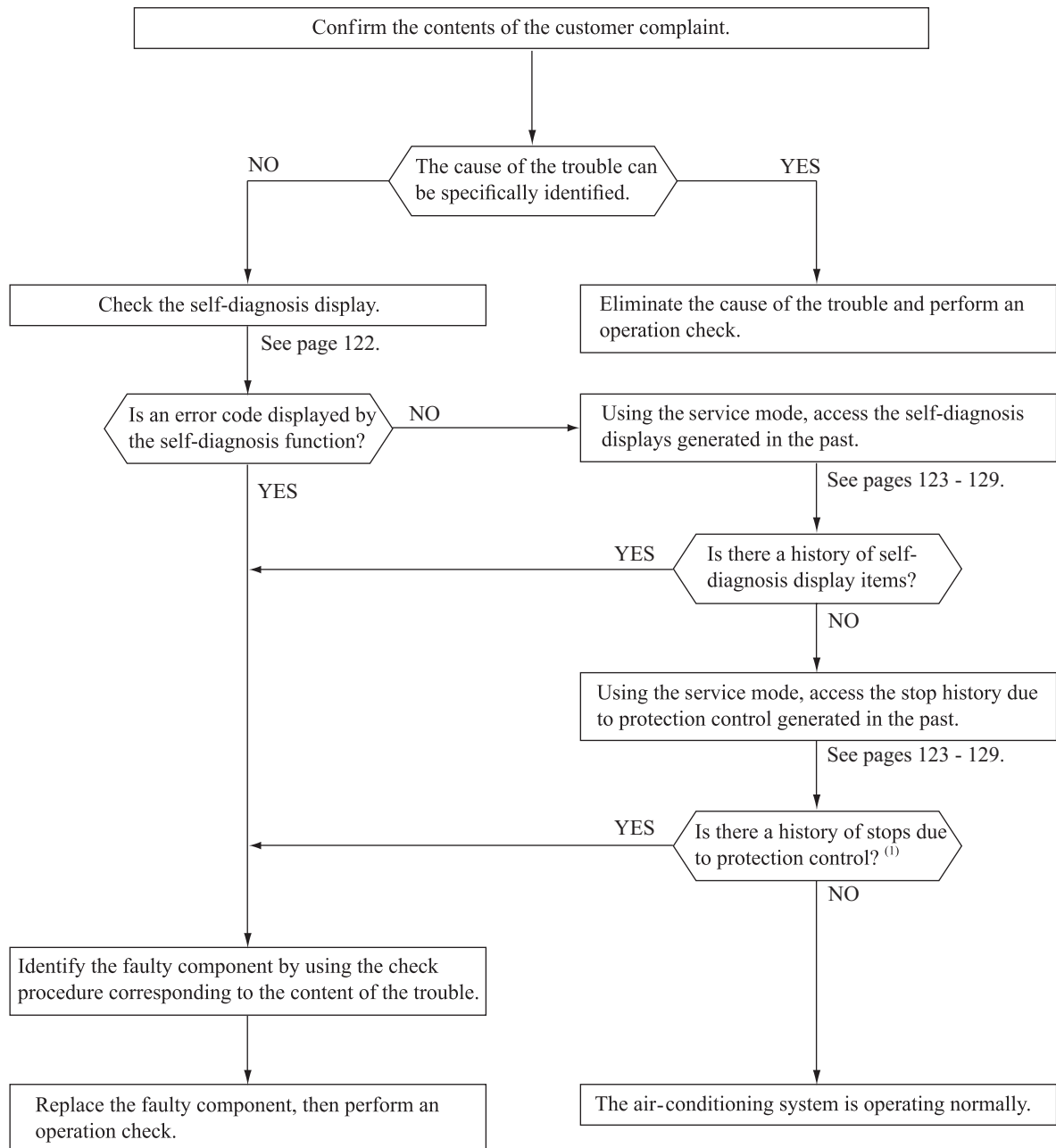

Note (1) Even in cases where only intermittent stop data are generated, the air-conditioning system is normal. However, if the same protective operation recurs repeatedly (3 or more times), it will lead to customer complaints. Judge the conditions in comparison with the contents of the complaints.

(5) Self-diagnosis table

When this air-conditioner performs an emergency stop, the reason why the emergency stop occurred is displayed by the flashing of display lights. If the air-conditioner is operated using the remote control 3 minutes or more after the emergency stop, the trouble display stops and the air-conditioner resumes operation. ⁽¹⁾

Indoor unit display panel		Wired remote control display ⁽²⁾	Description of trouble	Cause	Display (flashing) condition
RUN light	TIMER light				
1-time flash	ON	—	Heat exchanger sensor 1 error	<ul style="list-style-type: none"> Broken heat exchanger sensor 1 wire, poor connector connection Indoor unit PCB is faulty 	When a heat exchanger sensor 1 wire disconnection is detected while operation is stopped. (If a temperature of -28°C or lower is detected for 15 seconds, it is judged that the wire is disconnected.) (Not displayed during operation.)
2-time flash	ON	—	Room temperature sensor error	<ul style="list-style-type: none"> Broken room temperature sensor wire, poor connector connection Indoor unit PCB is faulty 	When a room temperature sensor wire disconnection is detected while operation is stopped. (If a temperature of -45°C or lower is detected for 15 seconds, it is judged that the wire is disconnected.) (Not displayed during operation.)
3-time flash	ON	—	Heat exchanger sensor 2 error	<ul style="list-style-type: none"> Broken heat exchanger sensor 2 wire, poor connector connection Indoor unit PCB is faulty 	When a heat exchanger sensor 2 wire disconnection is detected while operation is stopped. (If a temperature of -28°C or lower is detected for 15 seconds, it is judged that the wire is disconnected.) (Not displayed during operation.)
6-time flash	ON	E 16	Indoor fan motor error	<ul style="list-style-type: none"> Defective fan motor, poor connector connection 	When conditions for turning the indoor unit's fan motor on exist during air-conditioner operation, an indoor unit fan motor speed of 300 min ⁻¹ or lower is measured for 30 seconds or longer. (The air-conditioner stops.)
Keeps flashing	1-time flash	E 38	Outdoor air temperature sensor error	<ul style="list-style-type: none"> Broken outdoor air temp. sensor wire, poor connector connection Outdoor unit PCB is faulty 	-55°C or lower is detected for 5 seconds continuously 3 times within 40 minutes after initial detection of this anomalous temperature. Or -55°C or lower is detected for within 20 seconds after power ON. (The compressor is stopped.)
Keeps flashing	2-time flash	E 37	Outdoor heat exchanger sensor error	<ul style="list-style-type: none"> Broken heat exchanger sensor wire, poor connector connection Outdoor unit PCB is faulty 	-55°C or lower is detected for 5 seconds continuously 3 times within 40 minutes after initial detection of this anomalous temperature. Or -55°C or lower is detected for within 20 seconds after power ON. (The compressor is stopped.)
Keeps flashing	4-time flash	E 39	Discharge pipe sensor error	<ul style="list-style-type: none"> Broken discharge pipe sensor wire, poor connector connection Outdoor PCB is faulty 	-25°C or lower is detected for 5 seconds continuously 3 times within 40 minutes after initial detection of this anomalous temperature. (The compressor is stopped.)
ON	1-time flash	E 42	Current cut	<ul style="list-style-type: none"> Compressor locking, open phase on compressor output, short-circuit on power transistor, service valve is closed 	The compressor output current exceeds the set value during compressor start. (The air-conditioner stops.)
ON	2-time flash	E 59	Compressor startup failure	<ul style="list-style-type: none"> Defective compressor Outdoor unit PCB is faulty 	If compressor fails to startup for 42 times.
ON	3-time flash	E 58	Current safe stop	<ul style="list-style-type: none"> Overload operation Overcharge Compressor locking 	When the compressor command speed is lower than the set value and the current safe has operated. (the compressor stops)
ON	4-time flash	E 51	Power transistor anomaly	<ul style="list-style-type: none"> Power transistor error (Outdoor unit PCB is faulty) 	If the power transistor primary current exceeds the setting value for 3 seconds, the compressor stops.
ON	5-time flash	E 36	Discharge pipe temperature error	<ul style="list-style-type: none"> Installation, operation status Discharge pipe temperature sensor Outdoor unit PCB is faulty 	When discharge pipe temperature anomaly is detected 2 times within 60 minutes is compressor stop.
ON	6-time flash	E 5	Error of signal transmission	<ul style="list-style-type: none"> Defective power source, Broken signal wire, defective indoor/outdoor PCB 	When there is no signal between the indoor unit PCB and outdoor unit PCB for 10 seconds or longer (when the power is turned on), or when there is no signal for 7 minute 35 seconds or longer (during operation) (the compressor is stopped).
ON	7-time flash	E 48	Outdoor fan motor error	<ul style="list-style-type: none"> Defective fan motor, poor connector connection 	When the outdoor fan motor speed continues for 30 seconds or longer at 75 min ⁻¹ or lower. (3 times) (The air-conditioner stops.)
ON	Keeps flashing	E 35	Cooling overload operation	<ul style="list-style-type: none"> Installation, operation status Outdoor heat exchanger temperature sensor Outdoor unit PCB is faulty 	When the value of the outdoor heat exchanger sensor exceeds the set value.
2-time flash	2-time flash	E 60	Compressor rotor lock error	<ul style="list-style-type: none"> Defective compressor 	If it fails again to detect the rotor position after shifting to the compressor rotor position detection operation, the compressor stops.
5-time flash	ON	E 47	Active filter voltage error	<ul style="list-style-type: none"> Outdoor unit PCB is faulty 	Error is displayed if the converter voltage exceeds target voltage (3 times within 20 minutes). Remote control may be set after 3-minute delay. Error is displayed if the converter voltage is lower than 210V.
7-time flash	ON	E 57	Insufficient refrigerant amount or detection of service valve closure	<ul style="list-style-type: none"> Operation status Installation status 	When the insufficient refrigerant amount is detected 3 times within 60 minutes.
7-time flash	1-time flash	E 40	Service valve (gas side) closed operation	<ul style="list-style-type: none"> Service valve (gas side) closed Defective outdoor unit PCB 	If the output current of inverter exceeds the specifications, it makes the compressor stopping. (In heating mode).
—	—	E 1	Error of wired remote control wiring	<ul style="list-style-type: none"> Broken wired remote control wire, defective indoor unit PCB 	The wired remote control wire Y is open. The wired remote control wires X and Y are reversely connected. Noise is penetrating the wired remote control lines. The wired remote control or indoor unit PCB is faulty. (The communications circuit is faulty.)

Notes (1)The air-conditioner cannot be restarted using the remote control for 3 minutes after operation stops.

(2)The wired remote control is option parts.

(6) Service mode (Trouble mode access function)

This air-conditioner is capable of recording error displays and protective stops (service data) which have occurred in the past. If self-diagnosis displays cannot be confirmed, it is possible to get a grasp of the conditions at the time trouble occurred by checking these service data.

(a) Explanation of terms

Term	Explanation
Service mode	The service mode is the mode where service data are displayed by flashing of the display lights when the operations in item (b) below are performed with the indoor control.
Service data	These are the contents of error displays and protective stops which occurred in the past in the air-conditioner system. Error display contents and protective stop data from past anomalous operations of the air-conditioner system are saved in the indoor unit control's non-volatile memory (memory which is not erased when the power goes off). There are two types of data, self-diagnosis data and stop data, described below.
Self-diagnosis data	These are the data which display the reason why a stop occurred when an error display(self-diagnosis display) occurred in an indoor unit. Data are recorded for up to 5 previous occurrences. Data which are older than the 5th previous occurrence are erased. In addition, data on the temperature of each sensor (room temperature, indoor heat exchanger, outdoor heat exchanger, outdoor air temperature, discharge pipe), remote control information (operation switching, fan speed switching) are recorded when trouble occurs, so more detailed information can be checked.
Stop data	These are the data which display the reason by a stop occurred when the air-conditioning system performed protective stops, etc. in the past. Even if stop data alone are generated, the system restarts automatically. (After executing the stop mode while the display is normal, the system restarts automatically.) Data for up to 10 previous occasions are stored. Data older than the 10th previous occasion are erased. (Important) In cases where transient stop data only are generated, the air-conditioner system may still be normal. However, if the same protective stop occurs frequently (3 or more times), it could lead to customer complaints.

(b) Service mode display procedure

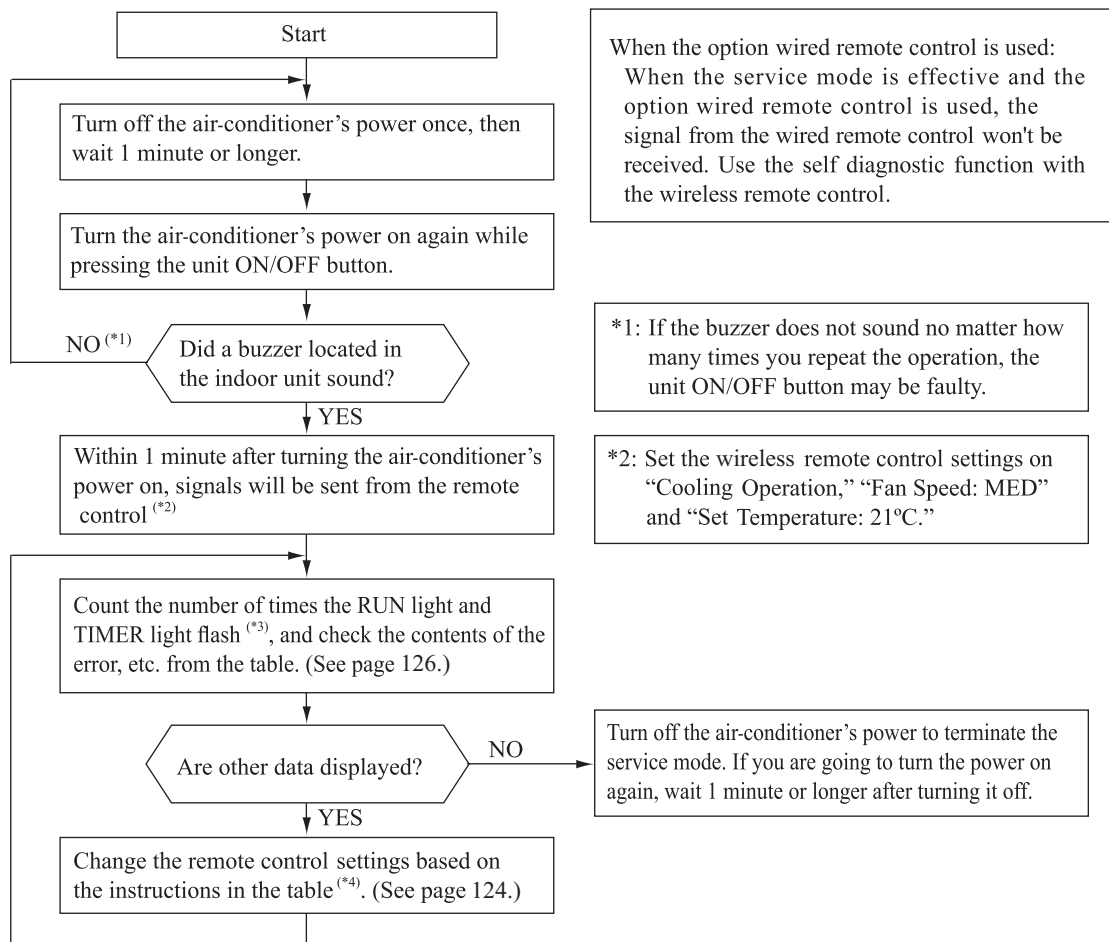

*3: To count the number of flashes in the service mode, count the number of flashes after the light lights up for 1.5 second initially (start signal). (The time that the light lights up for 1.5 second (start signal) is not counted in the number of flashes.)

• In the case of current cut (example: stop code "42")
 The RUN light (10's digit) 4-time flash and the TIMER light (1's digit) 2-time flash.
 $4 \times 10 + 2 \times 1 = 42 \rightarrow$ From the table, read the instructions for error code 42, "current cut".

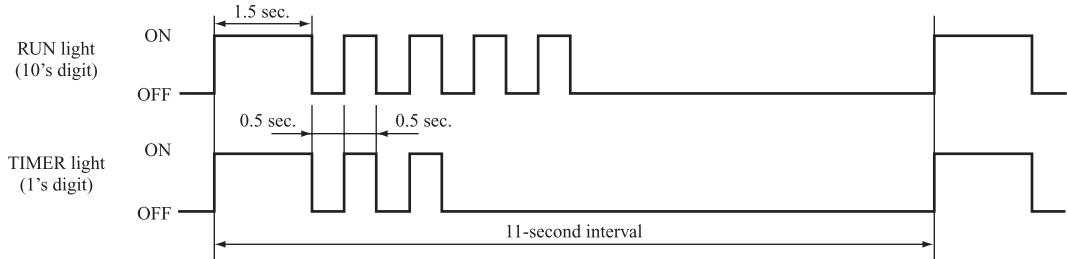

*4: When in the service mode, when the wireless remote control settings (operation mode, fan speed mode, temperature setting) are set as shown in the following table and sent to the air-conditioner unit, the unit switches to display of service data.

(i) Self-diagnosis data

What are Self-diagnosis Data?

These are control data (reasons for stops, temperature at each sensor, wireless remote control information) from the time when there were error displays (a bnormal stops) in the indoor unit in the past.

Data from up to 5 previous occasions are stored in memory. Data older than the 5th previous occasion are erased.

The temperature setting indicates how many occasions previous to the present setting the error display data are and the operation mode and fan speed mode data show the type of data.

Wireless remote control setting		Contents of output data
Operation mode	Fan speed mode	
Cooling	MED	Displays the reason for stopping display in the past (error code).
	HI	Displays the room temperature sensor temperature at the time the error code was displayed in the past.
	AUTO	Displays the indoor heat exchanger sensor temperature at the time the error code was displayed in the past.
Heating	LO	Displays the wireless remote control information at the time the error code was displayed in the past.
	MED	Displays the outdoor air temperature sensor temperature at the time the error code was displayed in the past.
	HI	Displays the outdoor heat exchanger sensor temperature at the time the error code was displayed in the past.
	AUTO	Displays the discharge pipe sensor temperature at the time the error code was displayed in the past.

Wireless remote control setting	Indicates the number of occasions previous to the present the error display data are from.
Temperature setting	
21°C	1 time previous (previous time)
22°C	2 times previous
23°C	3 times previous
24°C	4 times previous
25°C	5 times previous

Only for indoor heat exchanger temperature sensor 2

Wireless remote control setting	Indicates the number of occasions previous to the present the error display data are from.
Temperature setting	
26°C	1 time previous (previous time)
27°C	2 times previous
28°C	3 times previous
29°C	4 times previous
30°C	5 times previous

(Example)

Wireless remote control setting			Displayed data
Operation mode	Fan speed mode	Temperature setting	
Cooling	MED	21°C	Displays the reason for the stop (error code) the previous time an error was displayed.
		22°C	Displays the reason for the stop (error code) 2 times previous when an error was displayed.
		23°C	Displays the reason for the stop (error code) 3 times previous when an error was displayed.
		24°C	Displays the reason for the stop (error code) 4 times previous when an error was displayed.
		25°C	Displays the reason for the stop (error code) 5 times previous when an error was displayed.

(ii) Stop data

Wireless remote control setting			Displayed data
Operation mode	Fan speed mode	Temperature setting	
Cooling	LO	21°C	Displays the reason for the stop (stop code) the previous time when the air-conditioner was stopped by protective stop control.
		22°C	Displays the reason for the stop (stop code) 2 times previous when the air-conditioner was stopped by protective stop control.
		23°C	Displays the reason for the stop (stop code) 3 times previous when the air-conditioner was stopped by protective stop control.
		24°C	Displays the reason for the stop (stop code) 4 times previous when the air-conditioner was stopped by protective stop control.
		25°C	Displays the reason for the stop (stop code) 5 times previous when the air-conditioner was stopped by protective stop control.
		26°C	Displays the reason for the stop (stop code) 6 times previous when the air-conditioner was stopped by protective stop control.
		27°C	Displays the reason for the stop (stop code) 7 times previous when the air-conditioner was stopped by protective stop control.
		28°C	Displays the reason for the stop (stop code) 8 times previous when the air-conditioner was stopped by protective stop control.
		29°C	Displays the reason for the stop (stop code) 9 times previous when the air-conditioner was stopped by protective stop control.
		30°C	Displays the reason for the stop (stop code) 10 times previous when the air-conditioner was stopped by protective stop control.

(c) Error code, stop code table (Assignment of error codes and stop codes is done in common for all models.)

Number of flashes when in service mode		Stop code or Error code	Error content	Cause	Occurrence conditions	Error display	Auto recovery
RUN light (10's digit)	TIMER light (1's digit)						
OFF	OFF	0	Normal	—	—	—	—
	1-time flash	01	Error of wired remote control wiring	Broken wired remote control wire, defective indoor unit PCB	The wired remote control wire Y is open. The wired remote control wires X and Y are reversely connected. Noise is penetrating the wired remote control lines. The wired remote control or indoor unit PCB is faulty.	—	○
	5-time flash	05	Can not receive signals for 35 seconds (if communications have recovered)	Power source is faulty. Power source cables and signal lines are improperly wired. Indoor or outdoor unit PCB are faulty.	When 35 seconds passes without communications signals from either the outdoor unit or the indoor unit being detected correctly.	○	—
3-time flash	5-time flash	35	Cooling high pressure control	Cooling overload operation. Outdoor unit fan speed drops. Outdoor heat exchanger sensor is short-circuit.	When the outdoor heat exchanger sensor's value exceeds the set value.	○ (5 times)	○
	6-time flash	36	Compressor overheat 115°C	Refrigerant is insufficient. Discharge pipe sensor is faulty. Service valve is closed.	When the discharge pipe sensor's value exceeds the set value.	○ (2 times)	○
	7-time flash	37	Outdoor heat exchanger sensor is abnormal	Outdoor heat exchanger sensor wire is disconnected. Connector connections are poor. Outdoor unit PCB is faulty.	-55°C or lower is detected for 5 seconds continuously 3 times within 40 minutes after initial detection of this anomalous temperature. Or -55°C lower is detected for 5 seconds continuously within 20 seconds after power ON.	○ (3 times)	○
	8-time flash	38	Outdoor air temperature sensor is abnormal	Outdoor air temperature sensor wire is disconnected. Connector connections are poor. Outdoor unit PCB is faulty.	-55°C or lower is detected for 5 seconds continuously 3 times within 40 minutes after initial detection of this anomalous temperature. Or -55°C lower is detected for 5 seconds continuously within 20 seconds after power ON.	○ (3 times)	○
	9-time flash	39	Discharge pipe sensor is abnormal (anomalous stop)	Discharge pipe sensor wire is disconnected. Connector connections are poor. Outdoor unit PCB is faulty.	-25°C or lower is detected for 5 seconds continuously 3 times within 40 minutes after initial detection of this anomalous temperature.	○ (3 times)	○
4-time flash	OFF	40	Service valve (gas side) closed operation	Service valve (gas side) closed Outdoor unit PCB is faulty.	If the inverter output current value exceeds the setting value within 80 seconds after the compressor ON in the heating mode, the compressor stops.	○ (2 times)	○
	2-time flash	42	Current cut	Compressor lock. Compressor wiring short-circuit. Compressor output is open phase. Outdoor unit PCB is faulty. Service valve is closed. Electronic expansion valve is faulty. Compressor is faulty.	In order to prevent from overcurrent of inverter, if the current exceeds the specifications, it makes the compressor stopping.	○ (2 times)	○
	7-time flash	47	Active filter voltage error	Defective active filter.	Error is displayed if the converter voltage exceeds target voltage (3 times within 20 minutes). Remote control may be set after 3-minute delay. Error is displayed if the converter voltage is lower than 210V (1-time within 5 seconds after power ON).	○	—
	8-time flash	48	Outdoor unit's fan motor is abnormal	Outdoor fan motor is faulty. Connector connections are poor. Outdoor unit PCB is faulty.	When a fan speed of 75 min ⁻¹ or lower continues for 30 seconds or longer.	○ (3 times)	○
5-time flash	1-time flash	51	Short-circuit in the power transistor (high side) Current cut circuit breakdown	Outdoor unit PCB is faulty. Power transistor is damaged.	When it is judged that the power transistor was damaged at the time the compressor started.	○	—
	7-time flash	57	Refrigeration cycle system protective control	Service valve is closed. Refrigerant is insufficient.	When refrigeration cycle system protective control operates.	○ (3 times)	○
	8-time flash	58	Current safe	Refrigerant is overcharge. Compressor lock. Overload operation.	When there is a current safe stop during operation.	—	○
	9-time flash	59	Compressor wiring is unconnection voltage drop Low speed protective control	Compressor wiring is disconnected. Power transistor is damaged. Power source construction is defective. Outdoor unit PCB is faulty. Compressor is faulty.	When the current is 1A or less at the time the compressor started. When the power source voltage drops during operation. When the compressor command speed is lower than 32 rps for 60 minutes.	○	○
6-time flash	OFF	60	Rotor lock	Compressor is faulty. Compressor output is open phase. Electronic expansion valve is faulty. Overload operation. Outdoor unit PCB is faulty.	After the compressor starts, when the compressor stops due to rotor lock.	○ (2 times)	○
	1-time flash	61	Connection lines between the indoor and outdoor units are faulty	Connection lines are faulty. Indoor or outdoor unit PCB are faulty.	When 10 seconds passes after the power is turned on without communications signals from the indoor or outdoor unit being detected correctly.	○	—
	2-time flash	62	Serial transmission error	Indoor or outdoor unit PCB are faulty. Noise is causing faulty operation.	When 7 minutes 35 seconds passes without communications signals from either the outdoor unit or the indoor unit being detected correctly.	○	—
8-time flash	OFF	80	Indoor unit's fan motor is abnormal	Indoor fan motor is faulty. Connector connections are poor. Indoor unit PCB is faulty.	When the indoor fan motor is detected to be running at 300 min ⁻¹ or lower speed with the fan motor in the ON condition while the air-conditioner is running.	○	—
	2-time flash	82	Indoor heat exchanger sensor is abnormal (anomalous stop)	Indoor heat exchanger sensor wire is disconnected. Connector connections are poor.	When a temperature of -28°C or lower is sensed continuously for 40 minutes during heating operation. (the compressor stops).	○	—
	4-time flash	84	Anti-condensation control	High humidity condition. Humidity sensor is faulty.	Anti-condensation prevention control is operating.	—	○
	5-time flash	85	Anti-frost control	Indoor unit fan speed drops. Indoor heat exchanger sensor is broken wire.	When the anti-frost control operates and the compressor stops during cooling operation.	—	○
	6-time flash	86	Heating high pressure control	Heating overload operation. Indoor unit fan speed drops. Indoor heat exchanger sensor is short-circuit.	When high pressure control operates during heating operation and the compressor stops.	—	○

Notes (1) The number of flashes when in the service mode do not include the 1.5 second period when the lights light up at first (start signal). (See the example shown below.)

• In the case of current cut (example: stop code "42")
 The RUN light (10's digit) 4-time flash and the TIMER light (1's digit) 2-time flash.
 $4 \times 10 + 2 \times 1 = 42 \rightarrow$ From the table, read the instructions for error code 42, "current cut".

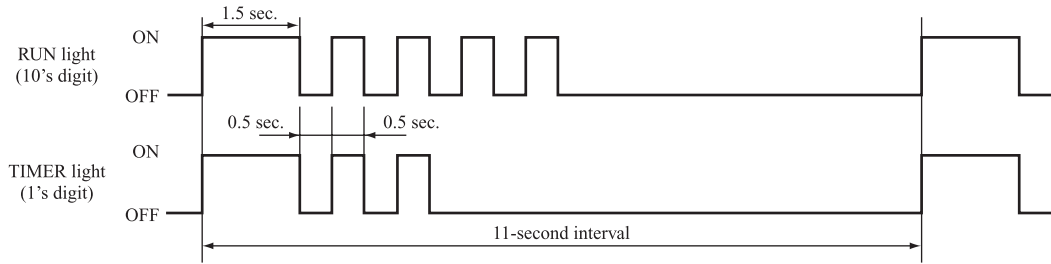

- (2) Error display:
 — Is not displayed. (automatic recovery only)
 Displayed.
 If there is a () displayed, the error display shows the number of times that an auto recovery occurred for the same reason has reached the number of times in ().
 If no () is displayed, the error display shows that the trouble has occurred once.
- (3) Auto Recovery:
 — Does not occur
 Auto recovery occurs.

(d) Operation mode, Fan speed mode information tables

(i) Operation mode

Display pattern when in service mode	Operation mode when there is an abnormal stop
RUN light (10's digit)	
—	AUTO
1-time flash	DRY
2-time flash	COOL
3-time flash	FAN
4-time flash	HEAT

(ii) Fan speed mode

Display pattern when in service mode	Fan speed mode when there is an abnormal stop
TIMER light (1's digit)	
—	AUTO
2-time flash	HI
3-time flash	MED
4-time flash	LO
5-time flash	ULO
6-time flash	HI POWER
7-time flash	ECONO

* If no data are recorded (error code is normal), the information display in the operation mode and fan speed mode becomes as follows.

Mode	Display when error code is normal.
Operation mode	AUTO
Fan speed mode	AUTO

(Example): Operation mode: COOL, Fan speed mode: HI

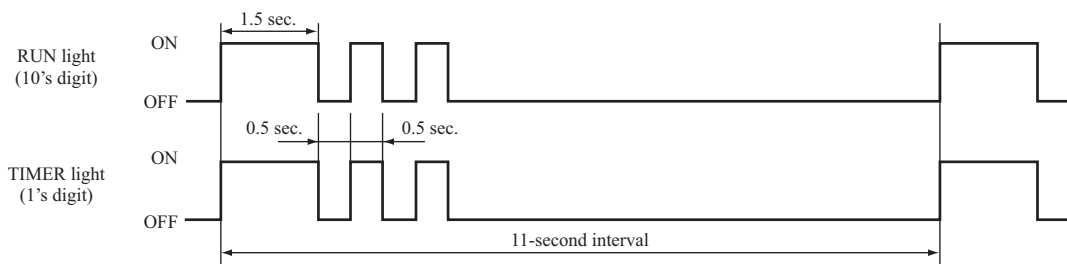

(e) Temperature information

(i) Room temperature sensor, indoor heat exchanger temperature sensor, outdoor air temperature sensor, outdoor heat exchanger temperature sensor temperature

Unit: °C

Buzzer sound	RUN light (10's digit)	TIMER light (1's digit)									
		0	1	2	3	4	5	6	7	8	9
Yes (sounds for 0.1 second)	6	-60	-61	-62	-63	-64					
	5	-50	-51	-52	-53	-54	-55	-56	-57	-58	-59
	4	-40	-41	-42	-43	-44	-45	-46	-47	-48	-49
	3	-30	-31	-32	-33	-34	-35	-36	-37	-38	-39
	2	-20	-21	-22	-23	-24	-25	-26	-27	-28	-29
	1	-10	-11	-12	-13	-14	-15	-16	-17	-18	-19
	0	/	-1	-2	-3	-4	-5	-6	-7	-8	-9
No (does not sound)	0	0	1	2	3	4	5	6	7	8	9
	1	10	11	12	13	14	15	16	17	18	19
	2	20	21	22	23	24	25	26	27	28	29
	3	30	31	32	33	34	35	36	37	38	39
	4	40	41	42	43	44	45	46	47	48	49
	5	50	51	52	53	54	55	56	57	58	59
	6	60	61	62	63	64	65	66	67	68	69
	7	70	71	72	73	74	75	76	77	78	79
	8	80	81	82	83	84	85	86	87	88	89
	9	90	91	92	93	94	95	96	97	98	99

* If no data are recorded (error code is normal), the display for each temperature information becomes as shown below.

Sensor name	Sensor value displayed when the error code is normal
Room temperature sensor	-64°C
Indoor heat exchanger temperature sensor	-64°C
Outdoor air temperature sensor	-64°C
Outdoor heat exchanger temperature sensor	-64°C

(Example) Outdoor heat exchanger temperature data: “-9°C”

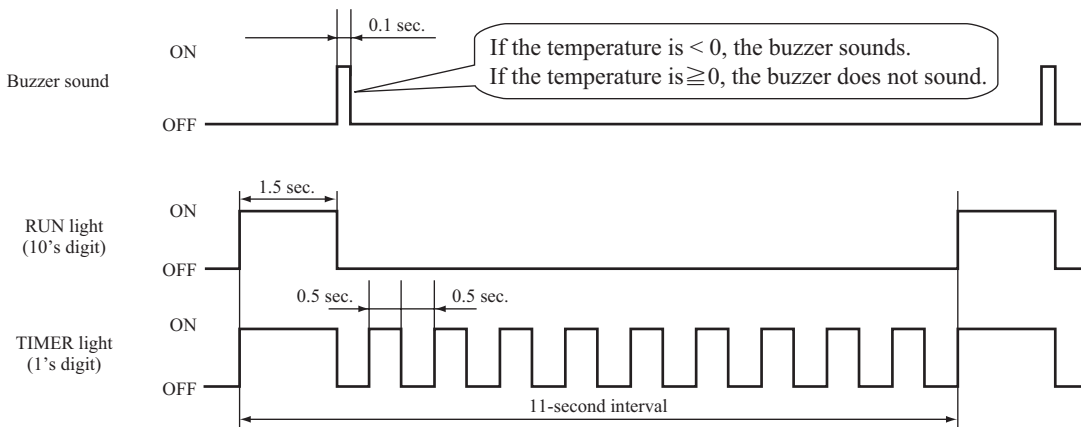

(ii) Discharge pipe sensor temperature

Unit: °C

Buzzer sound	RUN light (10's digit)	TIMER light (1's digit)											
		0	1	2	3	4	5	6	7	8	9		
Yes (sounds for 0.1 second)	3	-60	-62	-64									
	2	-40	-42	-44	-46	-48	-50	-52	-54	-56	-58		
	1	-20	-22	-24	-26	-28	-30	-32	-34	-36	-38		
	0	/	-2	-4	-6	-8	-10	-12	-14	-16	-18		
No (does not sound)	0	0	2	4	6	8	10	12	14	16	18		
	1	20	22	24	26	28	30	32	34	36	38		
	2	40	42	44	46	48	50	52	54	56	58		
	3	60	62	64	66	68	70	72	74	76	78		
	4	80	82	84	86	88	90	92	94	96	98		
	5	100	102	104	106	108	110	112	114	116	118		
	6	120	122	124	126	128	130	132	134	136	138		
	7	140	142	144	146	148	150						

* If no data are recorded (error code is normal), the display for each temperature information becomes as shown below.

Sensor name	Sensor value displayed when the error code is normal
Discharge pipe temperature sensor	-64°C

(Example) Discharge pipe temperature data: "122°C"

* In the case of discharge pipe temperature data, multiply the reading value by 2. (Below, 61 x 2 = "122°C")

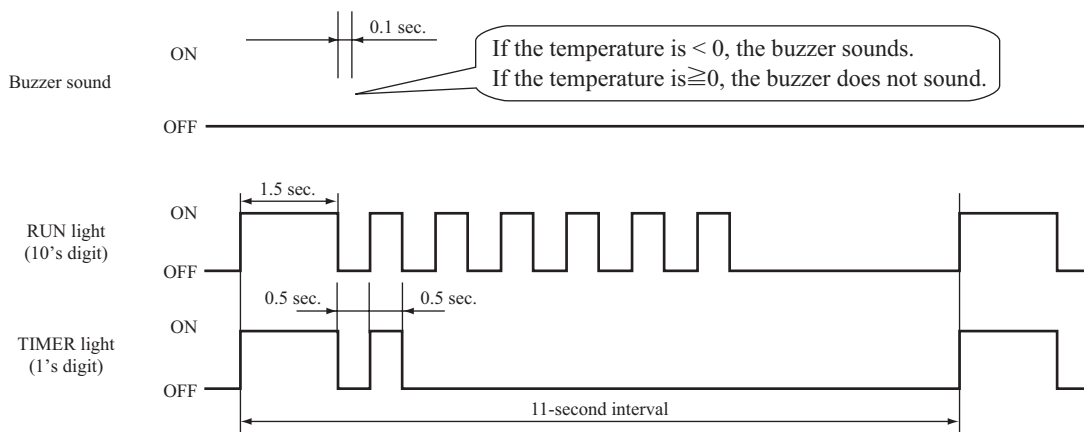

Service data record form

Customer		Model					
Date of investigation							
Machine name							
Content of complaint							
Wireless remote control settings			Content of displayed data	Display results			Display content
Temperature setting	Operation mode	Fan speed mode		Buzzer (Yes/No.)	RUN light (Times)	TIMER light (Times)	
21	Cooling	MED	Error code on previous occasion.	/			
		HI	Room temperature sensor on previous occasion.				
		AUTO	Indoor heat exchanger sensor 1 on previous occasion.				
	Heating	LO	Wireless remote control information on previous occasion.	/			
		MED	Outdoor air temperature sensor on previous occasion.				
		HI	Outdoor heat exchanger sensor on previous occasion.				
	AUTO	Discharge pipe sensor on previous occasion.					
26	Cooling	AUTO	Indoor heat exchanger sensor 2 on previous occasion.				
22	Cooling	MED	Error code on second previous occasion.	/			
		HI	Room temperature sensor on second previous occasion.				
		AUTO	Indoor heat exchanger sensor 1 on second previous occasion.				
	Heating	LO	Wireless remote control information on second previous occasion.	/			
		MED	Outdoor air temperature sensor on second previous occasion.				
		HI	Outdoor heat exchanger sensor on second previous occasion.				
	AUTO	Discharge pipe sensor on second previous occasion.					
27	Cooling	AUTO	Indoor heat exchanger sensor 2 on second occasion.				
23	Cooling	MED	Error code on third previous occasion.	/			
		HI	Room temperature sensor on third previous occasion.				
		AUTO	Indoor heat exchanger sensor 1 on third previous occasion.				
	Heating	LO	Wireless remote control information on third previous occasion.	/			
		MED	Outdoor air temperature sensor on third previous occasion.				
		HI	Outdoor heat exchanger sensor on third previous occasion.				
	AUTO	Discharge pipe sensor on third previous occasion.					
28	Cooling	AUTO	Indoor heat exchanger sensor 2 on third occasion.				
24	Cooling	MED	Error code on fourth previous occasion.	/			
		HI	Room temperature sensor on fourth previous occasion.				
		AUTO	Indoor heat exchanger sensor 1 on fourth previous occasion.				
	Heating	LO	Wireless remote control information on fourth previous occasion.	/			
		MED	Outdoor air temperature sensor on fourth previous occasion.				
		HI	Outdoor heat exchanger sensor on fourth previous occasion.				
	AUTO	Discharge pipe sensor on fourth previous occasion.					
29	Cooling	AUTO	Indoor heat exchanger sensor 2 on fourth occasion.				
25	Cooling	MED	Error code on fifth previous occasion.	/			
		HI	Room temperature sensor on fifth previous occasion.				
		AUTO	Indoor heat exchanger sensor 1 on fifth previous occasion.				
	Heating	LO	Wireless remote control information on fifth previous occasion.	/			
		MED	Outdoor air temperature sensor on fifth previous occasion.				
		HI	Outdoor heat exchanger sensor on fifth previous occasion.				
	AUTO	Discharge pipe sensor on fifth previous occasion.					
30	Cooling	AUTO	Indoor heat exchanger sensor 2 on fifth occasion.				
21	Cooling	LO	Stop code on previous occasion.				
22			Stop code on second previous occasion.				
23			Stop code on third previous occasion.				
24			Stop code on fourth previous occasion.				
25			Stop code on fifth previous occasion.				
26			Stop code on sixth previous occasion.				
27			Stop code on seventh previous occasion.				
28			Stop code on eighth previous occasion.				
29			Stop code on ninth previous occasion.				
30			Stop code on tenth previous occasion.				
Judgment							Examiner
Remarks							

Note (1) In the case of indoor heat exchanger sensor 2, match from 26 to 30 the temperature setting of wireless remote control. (Refer to page 124)

(7) Inspection procedures corresponding to detail of trouble

Sensor error

[Broken sensor wire, connector poor connection]

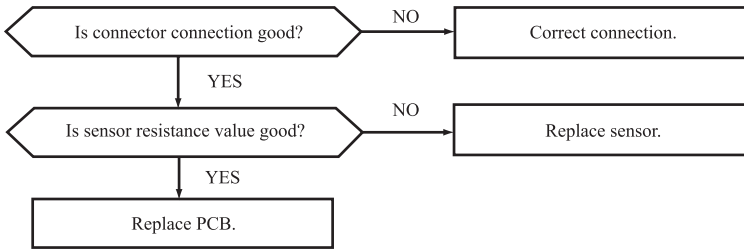

◆ **Sensor temperature characteristics**
(Room temperature, indoor heat exchanger temperature)

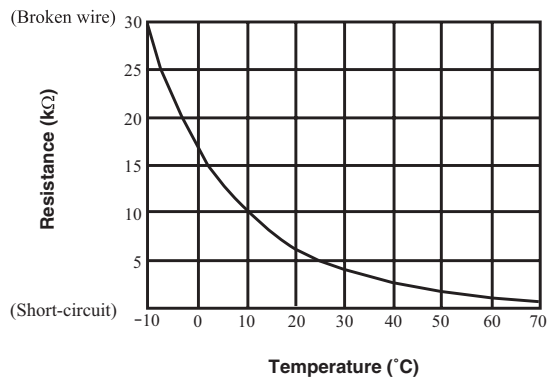

Indoor fan motor error

[Defective fan motor, connector poor connection, defective indoor unit PCB]

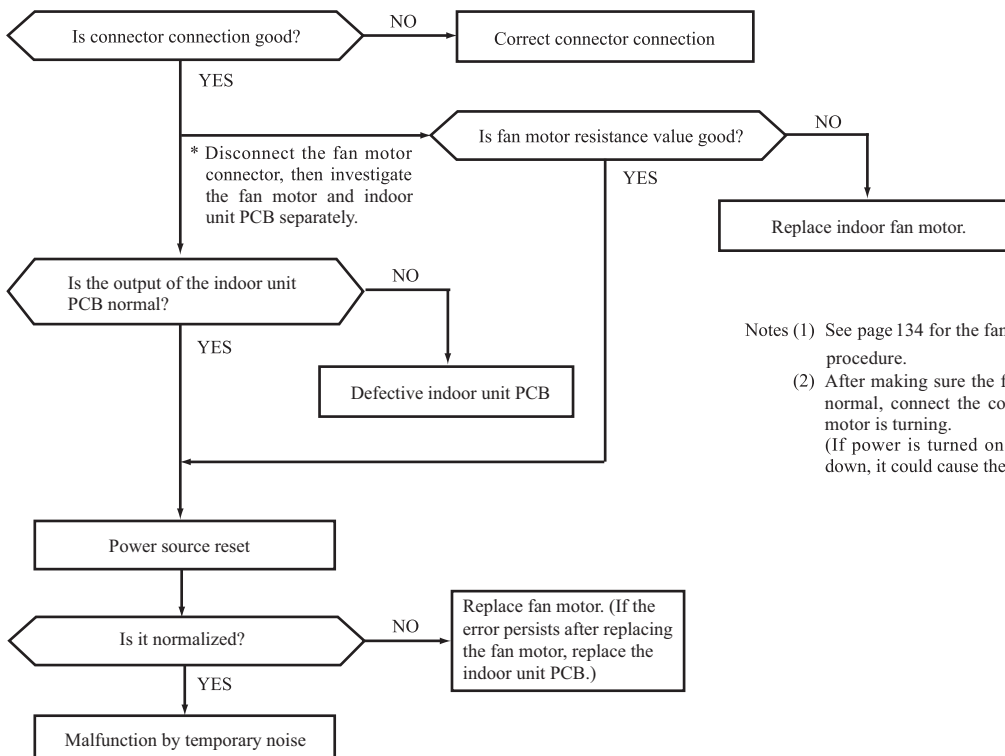

Notes (1) See page 134 for the fan motor and indoor unit PCB check procedure.
(2) After making sure the fan motor and indoor unit PCB are normal, connect the connectors and confirm that the fan motor is turning.
(If power is turned on while one or the other is broken down, it could cause the other to break down also.)

Error of signal transmission

[Wiring error including power cable, defective indoor/
outdoor unit PCB]

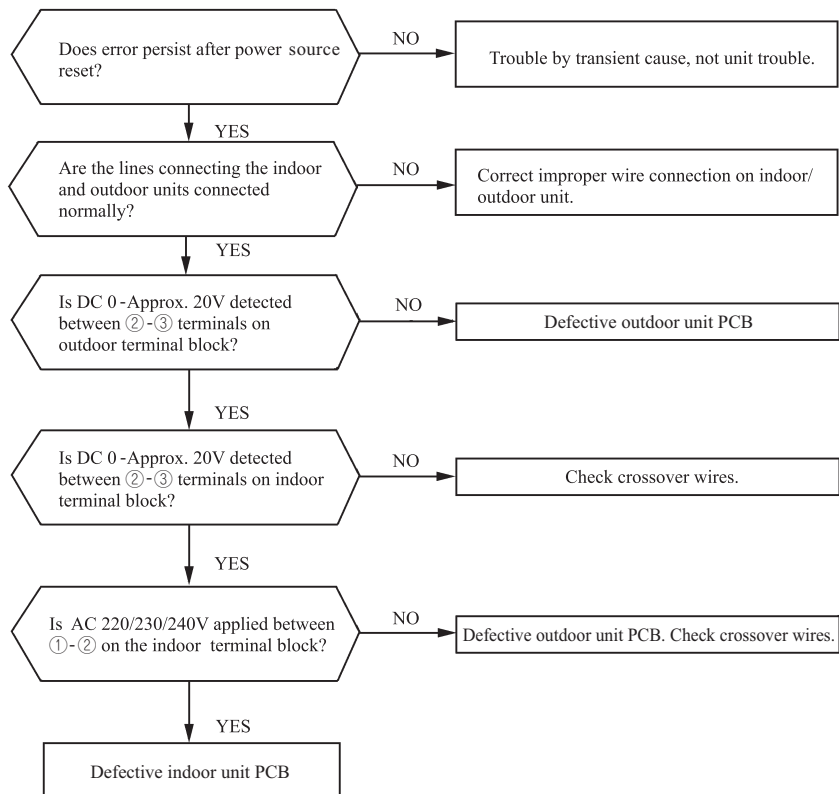

(8) Phenomenon observed after short-circuit, wire breakage on sensor

Sensor	Operation mode	Phenomenon	
		Short-circuit	Disconnected wire
Room temperature sensor	Cooling	Release of continuous compressor operation command.	Continuous compressor operation command is not released.
	Heating	Continuous compressor operation command is not released.	Release of continuous compressor operation command.
Heat exchanger temperature sensor	Cooling	Freezing cycle system protection trips and stops the compressor.	Continuous compressor operation command is not released. (Anti-frosting)
	Heating	High pressure control mode (Compressor stop command)	Hot keep (Indoor fan stop)
Humidity sensor	Cooling	Refer to the table below.	Refer to the table below.
	Heating	Normal system operation is possible.	

■ Humidity sensor operation

Failure mode	Control input circuit reading	Air-conditioning system operation
Disconnected wire	① Disconnected wire	Humidity reading is 0%
	② Disconnected wire	
	①② Disconnected wire	
Short-circuit	① and ② are short-circuited	Humidity reading is 100%

Remark: Do not perform a continuity check of the humidity sensor with a tester. If DC current is applied, it could damage the sensor.

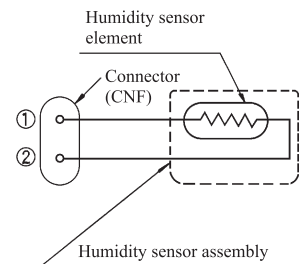

(9) Checking the indoor electrical equipment

(a) Indoor unit PCB check procedure

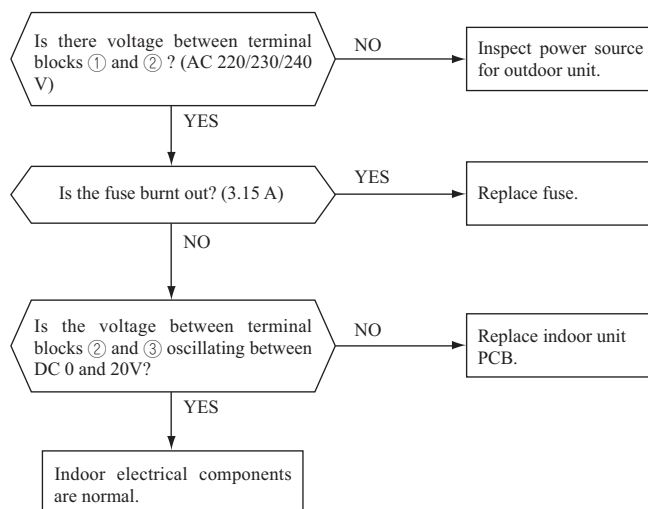

(b) Indoor fan motor check procedure

This is a diagnostic procedure for determining if the indoor fan motor or the indoor unit PCB is broken down.

(i) Indoor unit PCB output check

- 1) Turn off the power.
- 2) Remove the front panel, then disconnect the fan motor lead wire connector.
- 3) Turn on the power. If the unit operates when the ON/OFF button is pressed, if trouble is detected after the voltages in the following figure are output for approximately 30 seconds, it means that the indoor unit PCB is normal and the fan motor is broken down

If the voltages in the following figure are not output at connector pins No. ①, ④ and ⑤, the indoor unit PCB has failed and the fan motor is normal.

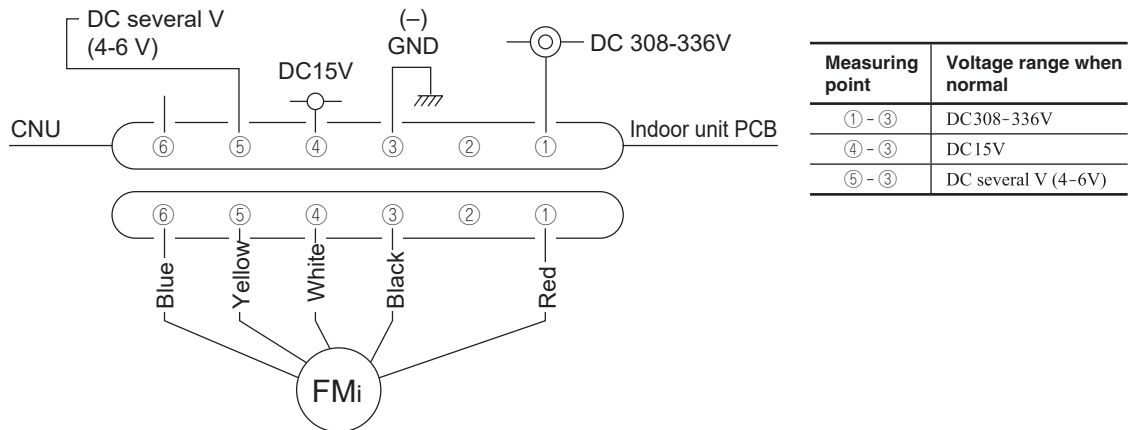

(ii) Fan motor resistance check

Measuring point	Resistance when normal
① - ③ (Red - Black)	20 MΩ or higher
④ - ③ (White - Black)	20 kΩ or higher

- Notes (1) Remove the fan motor and measure it without power connected to it.
 (2) If the measured value is below the value when the motor is normal, it means that the fan motor is faulty.

(10) How to make sure of wireless remote control

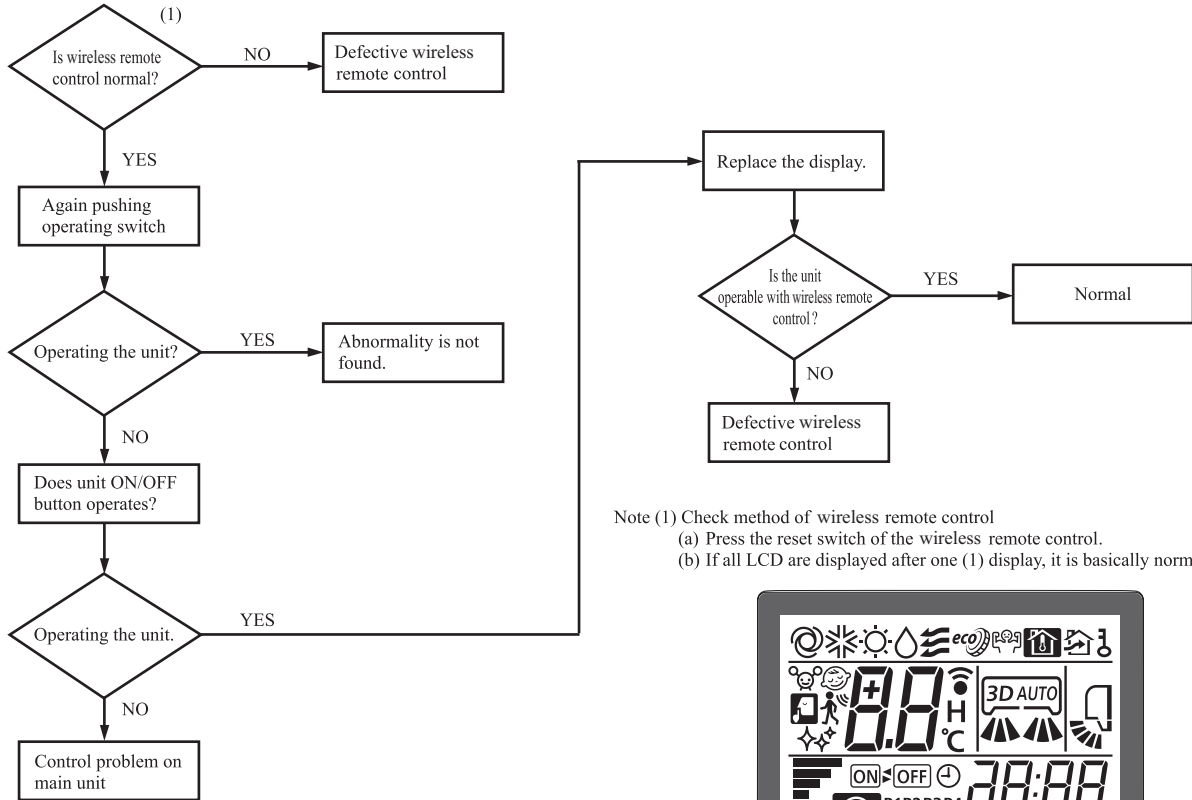

Note (1) Check method of wireless remote control
 (a) Press the reset switch of the wireless remote control.
 (b) If all LCD are displayed after one (1) display, it is basically normal.

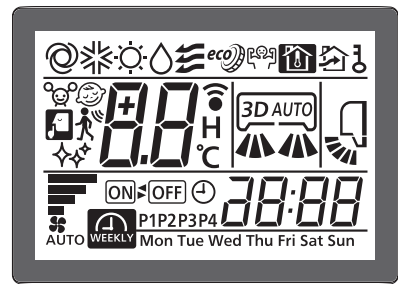

◆ Simplified check method of wireless remote control
 It is normal if the signal transmission section of the wireless remote control emits a whitish light at each transmission on the monitor of digital camera.

(11) Inspection procedure for blown fuse on the indoor unit PCB

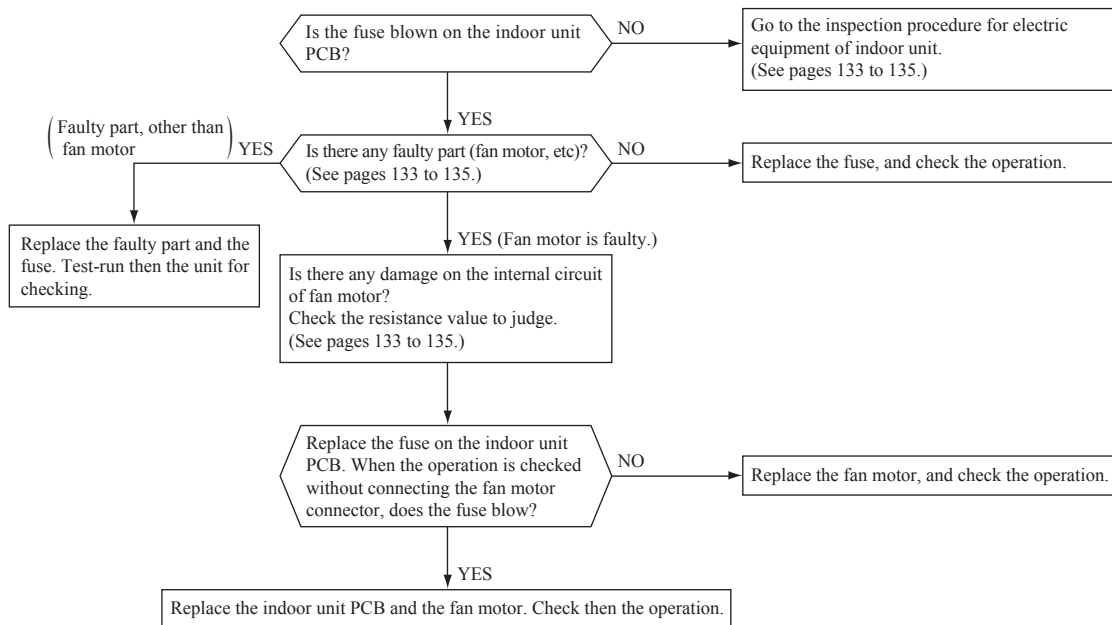

1.3 ELECTRICAL WIRING

(1) Indoor units

(a) Ceiling cassette-4 way type (FDT)

Models FDT40VH, 71VH

Meaning of marks

Item	Description
AM1-4	Draft prevention function motor
CNB-Z	Connector
DM	Drain pump motor
F1,2	Fuse
FMi	Fan motor
FS	Float switch
HS	Humidity sensor
L	Reactor
LED· 2	Indication lamp (Green-Normal operation)
LED· 3	Indication lamp (Red-Inspection)
LM1-4	Louver motor
PIS	Motion sensor
SW2	Remote control communication address
SW5	Plural units Master / Slave setting
SW6	Model capacity setting
SW7-1	Operation check/drain pump motor test run
TB1	Terminal block (Power source) (□ mark)
TB2	Terminal block (Signal line) (□ mark)
Th·C	Temperature sensor (Remote control)
Th·A	Temperature sensor (Return air)
Th·R1, 2, 3	Temperature sensor (Heat exchanger)

Color marks

Mark	Color	Mark	Color
BK	Black	WH	White
BL	Blue	YE	Yellow
BR	Brown	GY	Gray
OR	Orange	YE / GN	Yellow / Green
RD	Red		

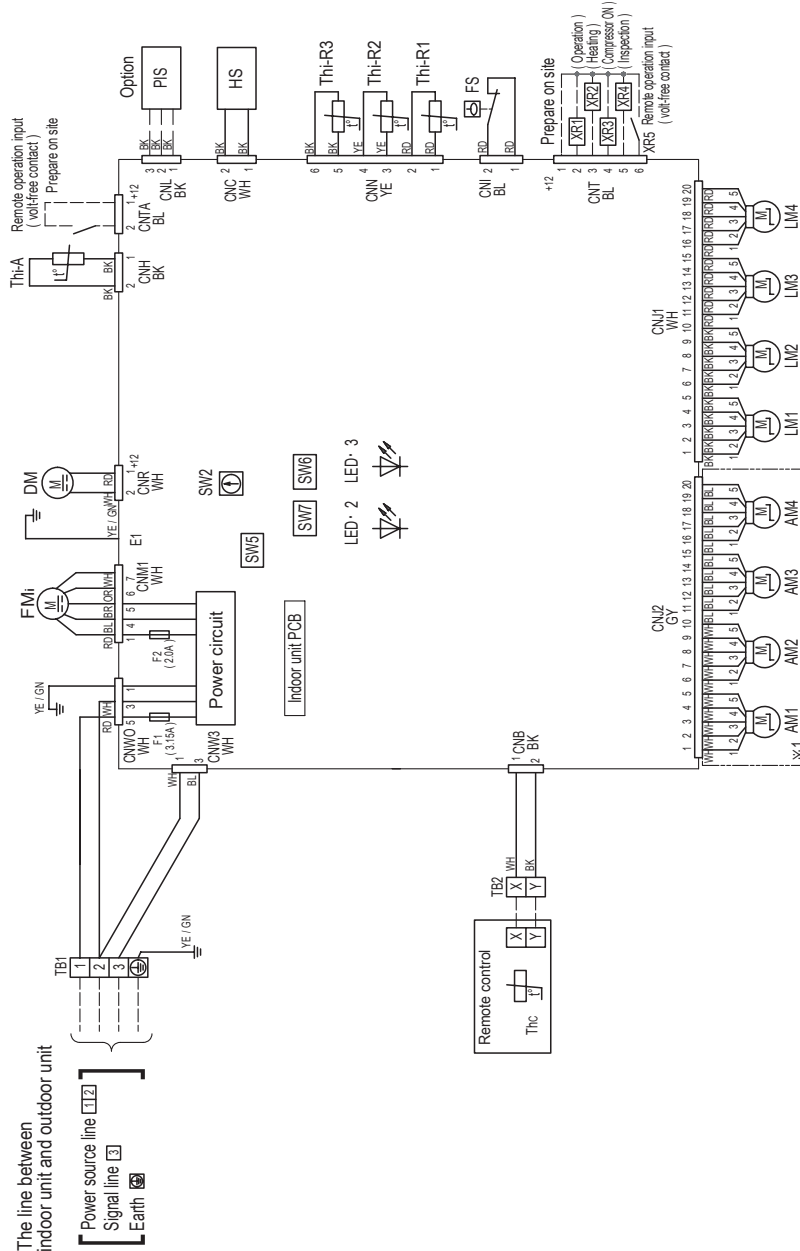

- Notes
- indicates wiring on site.
 - See the wiring diagram of outside unit about the line between indoor unit and outdoor unit.
 - Use twin core cord (0.3mm²) at remote control line.
See spec sheet of remote control in case that the total length is more than 100m.
 - Do not put remote control line alongside power source line.
 - Section 1 (※ 1) is provided on the panel T-PSAE-5AM/E only.

PJF000Z554

(b) Ceiling cassette-4 way compact type (FDTC)
Model FDTC40VH

Meaning of marks

Item	Description
AM1-4	Draft prevention function motor
CNB-Z	Connector
DM	Drain pump motor
F1,2	Fuse
FMi	Fan motor
FS	Float switch
HS	Humidity sensor
LED-2	Indication lamp (Green-Normal operation)
LED-3	Indication lamp (Red-Inspection)
LM1-4	Louver motor
PIS	Motion sensor
SW2	Remote control communication address
SW5	Plural units Master/ Slave setting
SW6	Model capacity setting
SW7-1	Operation check/drain pump motor test run
TB1	Terminal block (Power source) (□mark)
TB2	Terminal block (Signal line) (□mark)
Thc	Temperature sensor (Remote control)
Thi-A	Temperature sensor (Return air)
Thi-R1,2,3	Temperature sensor (Heat exchanger)

Color marks

Mark	Color	Mark	Color
BK	Black	WH	White
BL	Blue	YE	Yellow
BR	Brown	GY	Gray
OR	Orange	YE/GN	Yellow/Green
RD	Red		

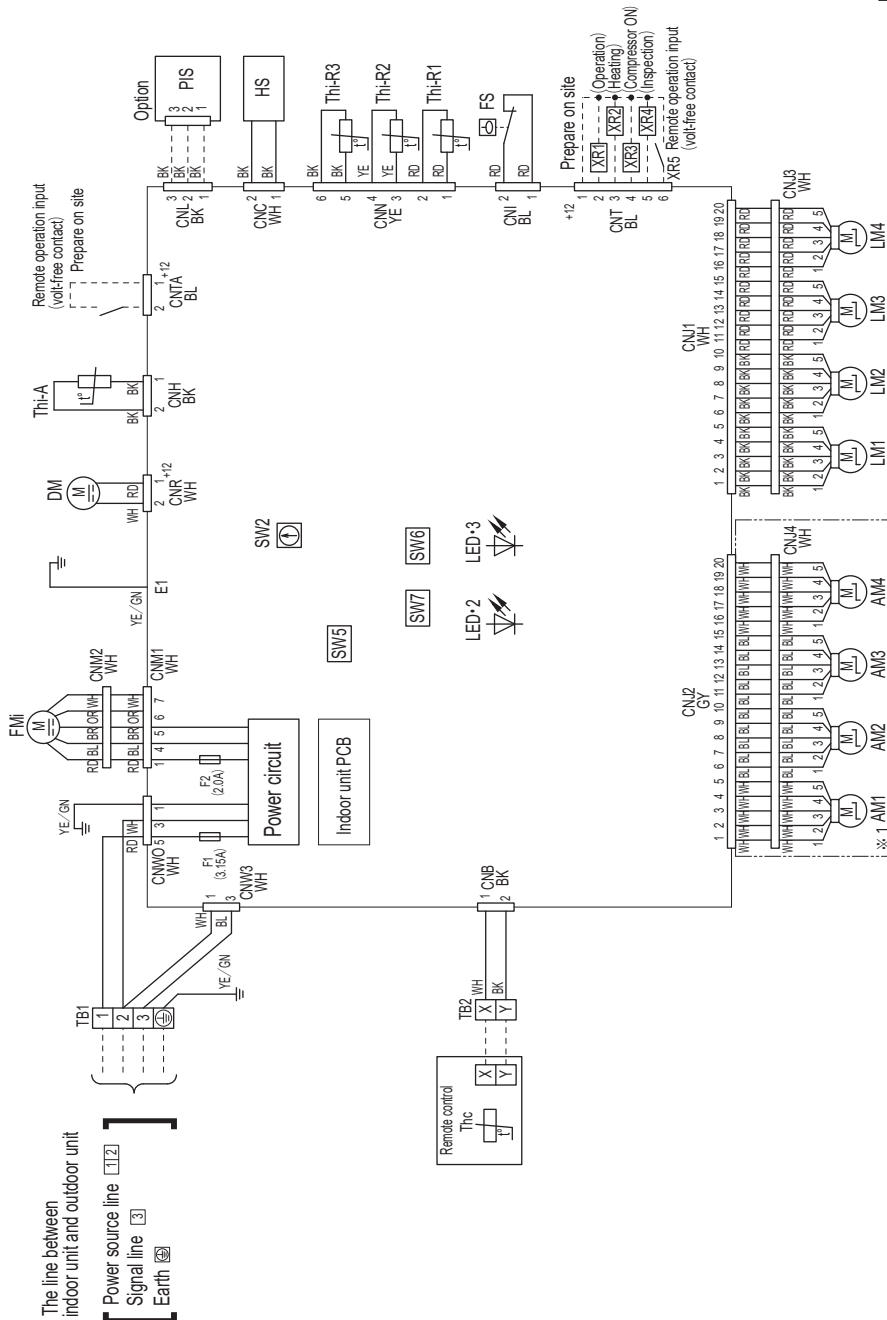

- Notes
1. ---- indicates wiring on site.
 2. See the wiring diagram of outdoor unit about the line between indoor unit and outdoor unit.
 3. Use twin core cord (0.3mm²) at remote control line.
 4. Do not put remote control line alongside power source line.
 5. Draft prevention function (※ 1) is provided on the panel TC-PSAE-5AW-E only.

(c) Duct connected-High static pressure type (FDU)

Model FDU71VH

Meaning of marks

Item	Description
CNB-Z	Connector
DM	Drain pump motor
F1,4	Fuse
FM2	Fan motor
FS	Float switch
L	Reactor
LED-2	Indication lamp (Green-Normal operation)
LED-3	Indication lamp (Red-Inspection)
PIS	Motion sensor
SW2	Remote control communication address
SW5	Plural units Master / Slave setting
SW6	Model capacity setting
SW7-1	Operation check, drain pump motor test run
TB1	Terminal block (Power source) (□mark)
TB2	Terminal block (Signal line) (□mark)
Thc	Temperature sensor (Remote control)
Thi-A	Temperature sensor (Return air)
Thi-R1,2,3	Temperature sensor (Heat exchanger)
□mark	Closed-end connector

Mark	Color
BK	Black
BL	Blue
RD	Red
WH	White
YE	Yellow
YE/GN	Yellow / Green

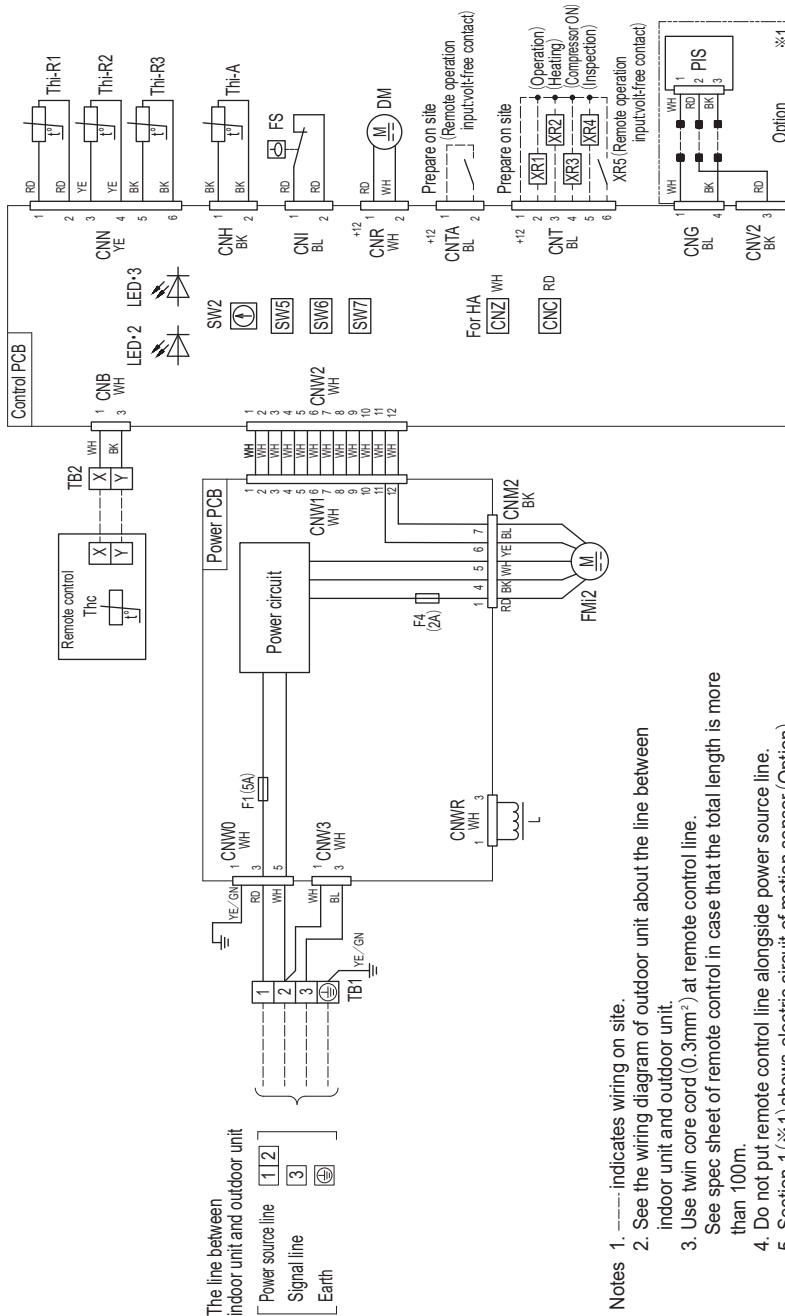

- Notes
1. - - - - indicates wiring on site.
 2. See the wiring diagram of outdoor unit about the line between indoor unit and outdoor unit.
 3. Use twin core cord (0.3mm²) at remote control line.
See spec sheet of remote control in case that the total length is more than 100m.
 4. Do not put remote control line alongside power source line.
 5. Section 1 (※1) shows electric circuit of motion sensor (Option).

(d) Duct connected-Low / Middle static pressure type (FDUM)
 Model FDUM40VH

Item	Description
CNB-Z	Connector
DM	Drain pump motor
F1-3	Fuse
FIM1	Fan motor
FS	Float switch
L	Reactor
LED-2	Indication lamp (Green-Normal operation)
LED-3	Indication lamp (Red-Inspection)
PIS	Motion sensor
SW2	Remote control communication address
SW5	Plural units Master / Slave setting
SW6	Model capacity setting
SW7-1	Operation check, drain pump motor test run
TB1	Terminal block (Power source) (□mark)
TB2	Terminal block (Signal line) (□mark)
Thc	Temperature sensor (Remote control)
Th-A	Temperature sensor (Return air)
Th-R1,2,3	Temperature sensor (Heat exchanger)
■mark	Closed-end connector

Color Marks	Mark	Color
	BK	Black
	BL	Blue
	BR	Brown
	OR	Orange
	RD	Red
	WH	White
	YE	Yellow
	YE/GN	Yellow/Green

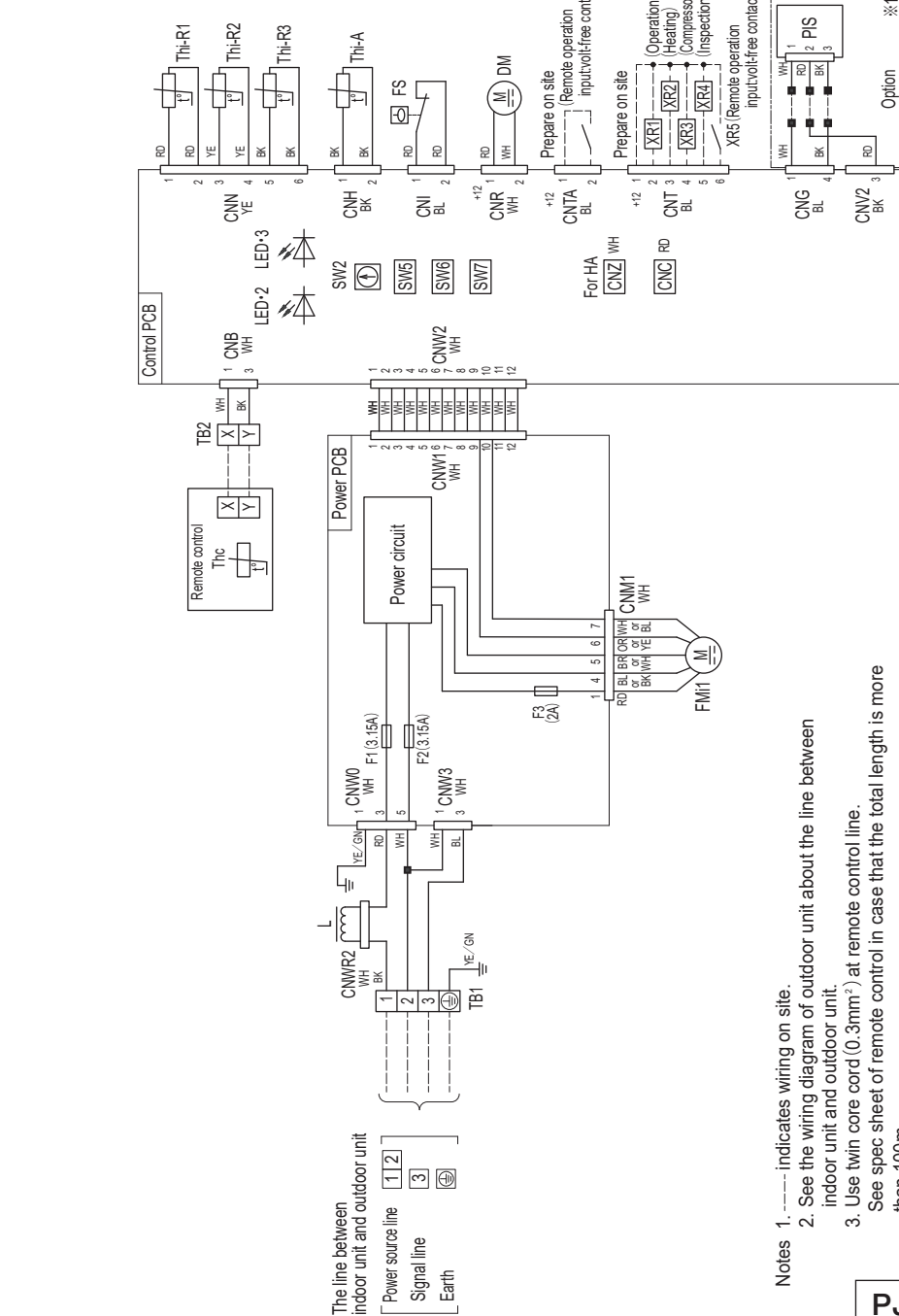

- Notes
1. --- indicates wiring on site.
 2. See the wiring diagram of outdoor unit about the line between indoor unit and outdoor unit.
 3. Use twin core cord (0.3mm²) at remote control line. See spec sheet of remote control in case that the total length is more than 100m.
 4. Do not put remote control line alongside power source line.
 5. Section 1 (※1) shows electric circuit of motion sensor (Option).

PJG000Z488

Model FDUM71VH

Meaning of marks

Item	Description
CNB-Z	Connector
DM	Drain pump motor
F1,4	Fuse
FM2	Fan motor
FS	Float switch
LED-2	Indication lamp (Green-Normal operation)
LED-3	Indication lamp (Red-Inspection)
PIS	Motion sensor
SW2	Remote control communication address
SW5	Plural units Master/ Slave setting
SW6	Model capacity setting
SW7-1	Operation check, drain pump motor test run
TB1	Terminal block (Power source) (□mark)
TB2	Terminal block (Signal line) (□mark)
Thc	Temperature sensor (Remote control)
Th-A	Temperature sensor (Return air)
Th-R1,2,3	Temperature sensor (Heat exchanger)
■mark	Closed-end connector

Color Marks

Mark	Color
BK	Black
BL	Blue
BR	Brown
OR	Orange
RD	Red
WH	White
YE	Yellow
YE/GN	Yellow/Green

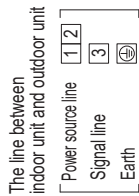
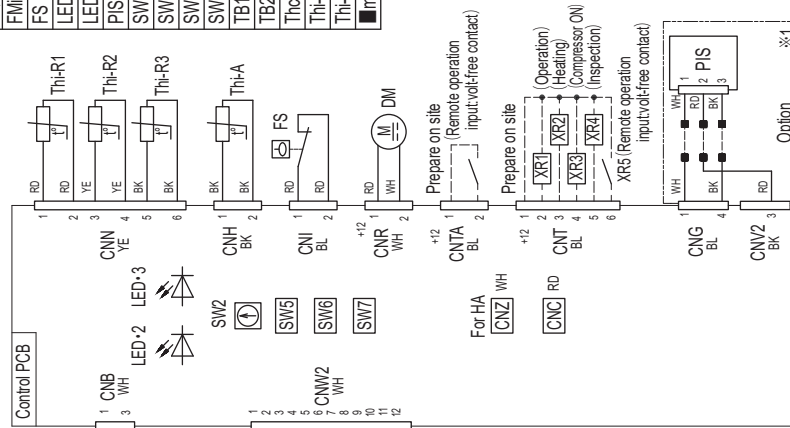

- Notes
1. --- indicates wiring on site.
 2. See the wiring diagram of outdoor unit about the line between indoor unit and outdoor unit.
 3. Use twin core cord (0.3mm²) at remote control line. See spec sheet of remote control in case that the total length is more than 100m.
 4. Do not put remote control line alongside power source line.
 5. Section 1 (※1) shows electric circuit of motion sensor (Option).

PJG000Z489

(e) Ceiling suspended type (FDE)
Models FDE40VH, 71VH

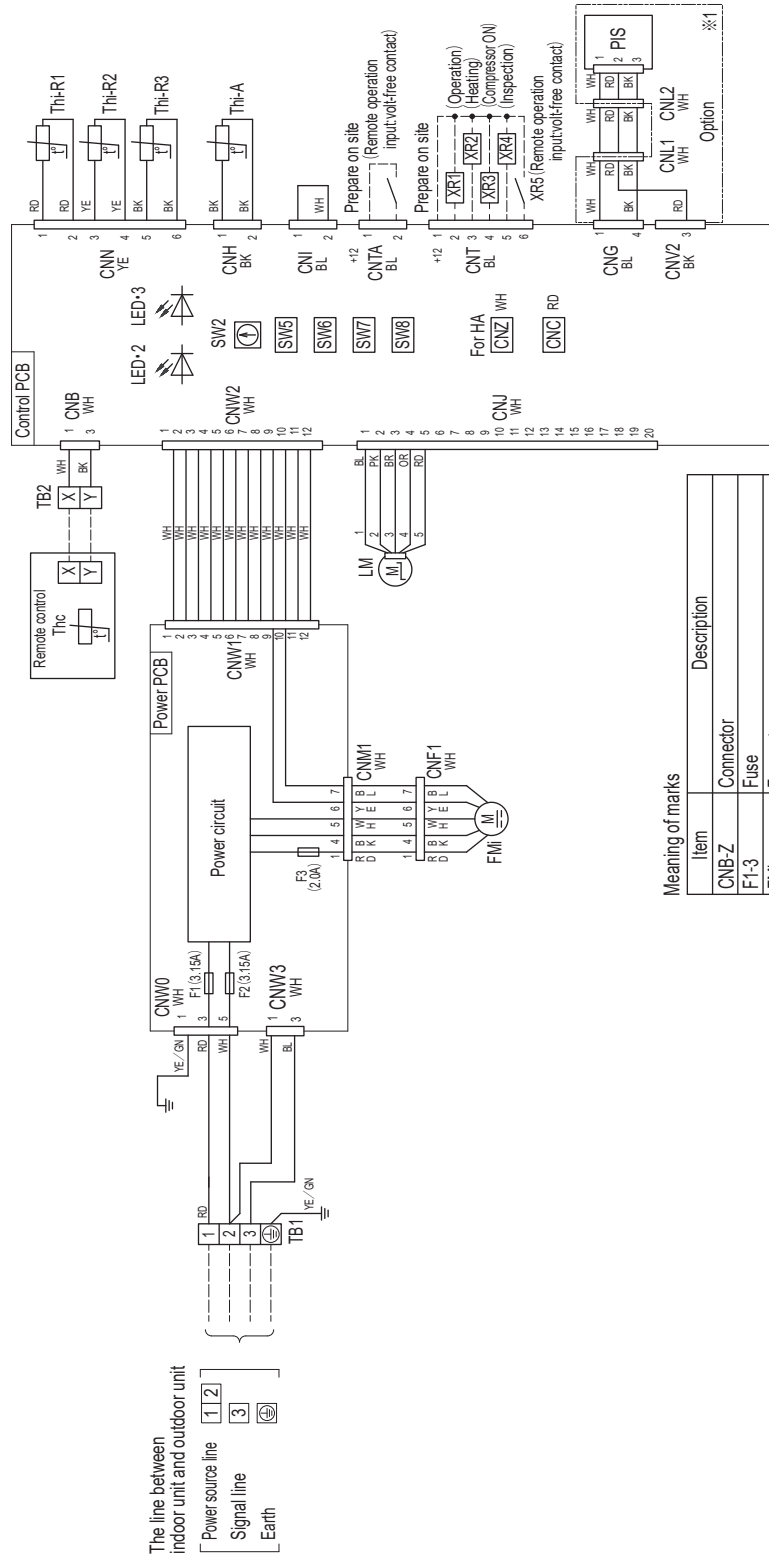

The line between indoor unit and outdoor unit

1	2
3	⊕

Power source line
Signal line
Earth

Meaning of marks

Item	Description
CNB-Z	Connector
F1-3	Fuse
FMI	Fan motor
L	Reactor
LED-2	Indication lamp (Green-Normal operation)
LED-3	Indication lamp (Red-Inspection)
LM	Lower motor
PIS	Motion sensor
SW2	Remote control communication address
SW5	Plural units Master / Slave setting
SW6	Model capacity setting
SW7-1	Operation check, drain pump motor, test run
SW8-1	Anti-freeze control
TB1	Terminal block (Power source) (□mark)
TB2	Terminal block (Signal line) (□mark)
Thc	Temperature sensor (Remote control)
Th-A	Temperature sensor (Return air)
Th-R1, 2, 3	Temperature sensor (Heat exchanger)

Color marks

Mark	Color
BK	Black
BL	Blue
BR	Brown
OR	Orange
PK	Pink
RD	Red
WH	White
YE	Yellow
YE/GN	Yellow/Green

- Notes
1. ----- indicates wiring on site.
 2. See the wiring diagram of outdoor unit about the line between indoor unit and outdoor unit.
 3. Use twin core cord (0.3mm²) at remote control line.
See spec sheet of remote control in case that the total length is more than 100m.
 4. Do not put remote control line alongside power source line.
 5. Section 1 (※1) shows electric circuit of motion sensor (Option).

(f) Wall mounted type (SRK)
Model SRK71ZR-W

Item	Description
CNE	Connector
CNF	
CNG	
CNM	
CNS	
CNU	
CNX	
CNY	
FMI	Fan motor
SM ₁	Flap motor
LM _{1,2}	Louver motor
Th1	Room temperature sensor
Th2,1,2	Heat exchanger temperature sensor
Th3	Humidity sensor
DS	Diode stack
F	Fuse
TB	Terminal block
Va	Varistor

Mark	Color
BK	Black
BL	Blue
RD	Red
WH	White
Y	Yellow
Y/G	Yellow/Green

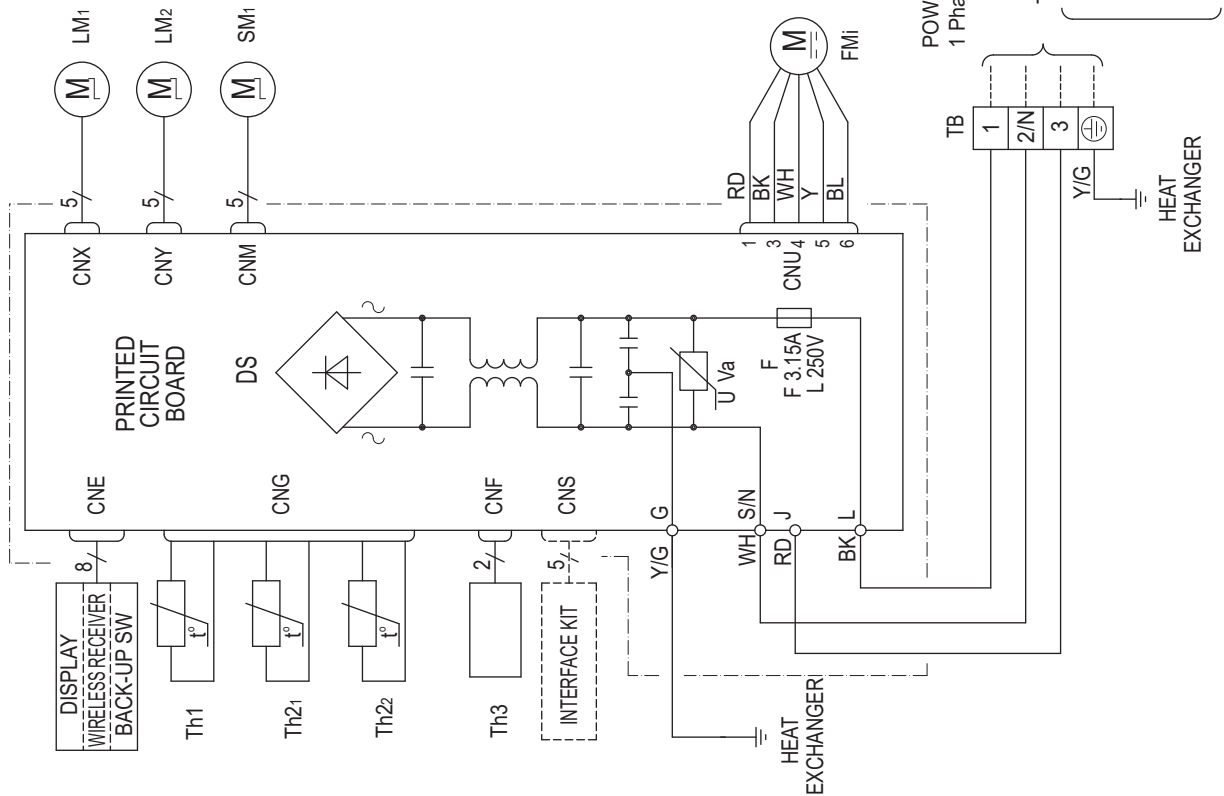

(2) Outdoor unit
Model FDC71VN-X-W

Meaning of marks

Item	Description
CM	Compressor motor
FM01	Fan motor
CH	Cartridge heater
52X1	Auxiliary relay (for CH)
52X3	Auxiliary relay (for ZUS)
ZUS	Expansion valve (for 4-way valve)
SM1	Expansion valve for cooling
SM2	Expansion valve for heating
63H1	High pressure switch
Tho-A	Temperature sensor (Outdoor air)
Tho-D	Temperature sensor (Discharge pipe)
Tho-R1,R2	Temperature sensor (Heat exchanger)
Tho-S	Temperature sensor (Suction pipe)
LPT	Low pressure sensor
IPM	Intelligent power module
TB	Terminal block
F1,F3,F6	Fuse
CNA-Z	Connector
SW8	Pump down switch
SW3,3.7,8	Local setting switch
LED1	Indication lamp (GREEN)
LED2	Indication lamp (RED)
L1,L2	Reactor

Color marks

Mark	Color
BK	Black
BL	Blue
BR	Brown
OR	Orange
RD	Red
WH	White
YE	Yellow
YG	Yellow/Green
GY	Gray
PK	Pink

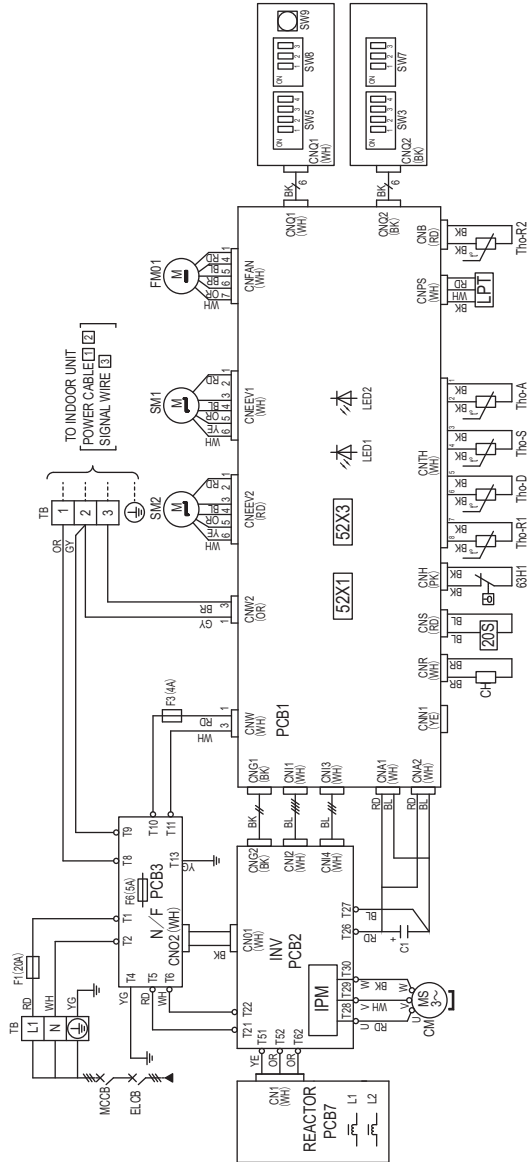

SW3-1	Defrost control change	The defrost operation interval becomes shorter by turning ON this switch. This switch should be turned ON in the area where outside temperature becomes below the freezing point.
SW3-2	Snow guard fan control	When this switch is turned ON, the outdoor unit fan will run for 10 seconds in every 10 minutes, when outdoor temperature falls to 3°C or lower and the compressor is not running when the unit is used in a very snowy country, set this switch to ON.
SW5-3,4	Trial operation	Method of trial operation 1. Trial operation can be performed by using SW5-3. 2. Cooldown trial operation will be performed when SW5-4 is OFF and heating trial operation when SW5-4 is ON. 3. Be sure to turn OFF SW5-3 after the trial operation is finished.

Power cable, indoor-outdoor connecting wires

Model	MAX over current (A)	Power cable size (mm ²)	Power cable length (m)	Indoor-outdoor wire size x number (mm ²)	Earth wire size (mm ²)
71	20	3.5	17	φ 1.6mm x 3	φ 1.6mm

- The specifications shown in the above table are for units without heaters. For units with heaters, refer to the installation instructions or the construction instructions of the indoor unit.
- Switchgear or circuit breaker capacity which is calculated from MAX. over current should be chosen along the regulations in each country.
- The cable specifications are based on the assumption that a metal or plastic conduit is used with no more than three cables contained in a conduit and a voltage drop is 2%. For an installation falling outside of these conditions, please follow the internal cabling regulations. Adapt it to the regulation in effect in each country.
- Don't operate SW3-3, SW5-1, SW5-2, SW7, SW8.

1.4 PIPING SYSTEM

(1) FDT, FDTC, FDU, FDUM, FDE series

(a) Single type

Model 71

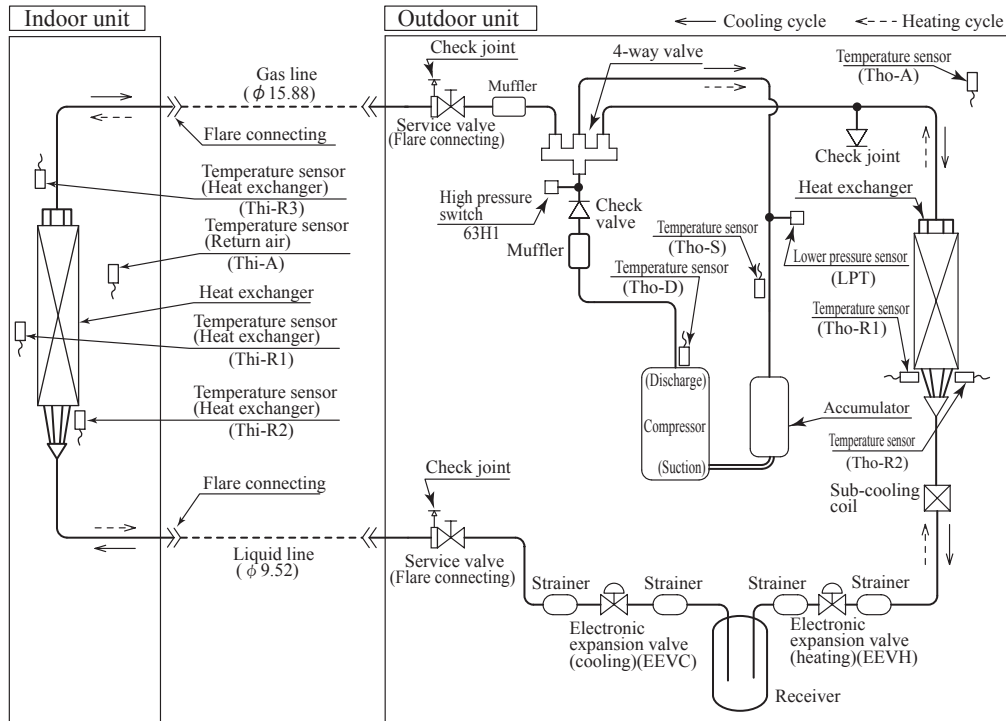

(b) Twin type

Model 71

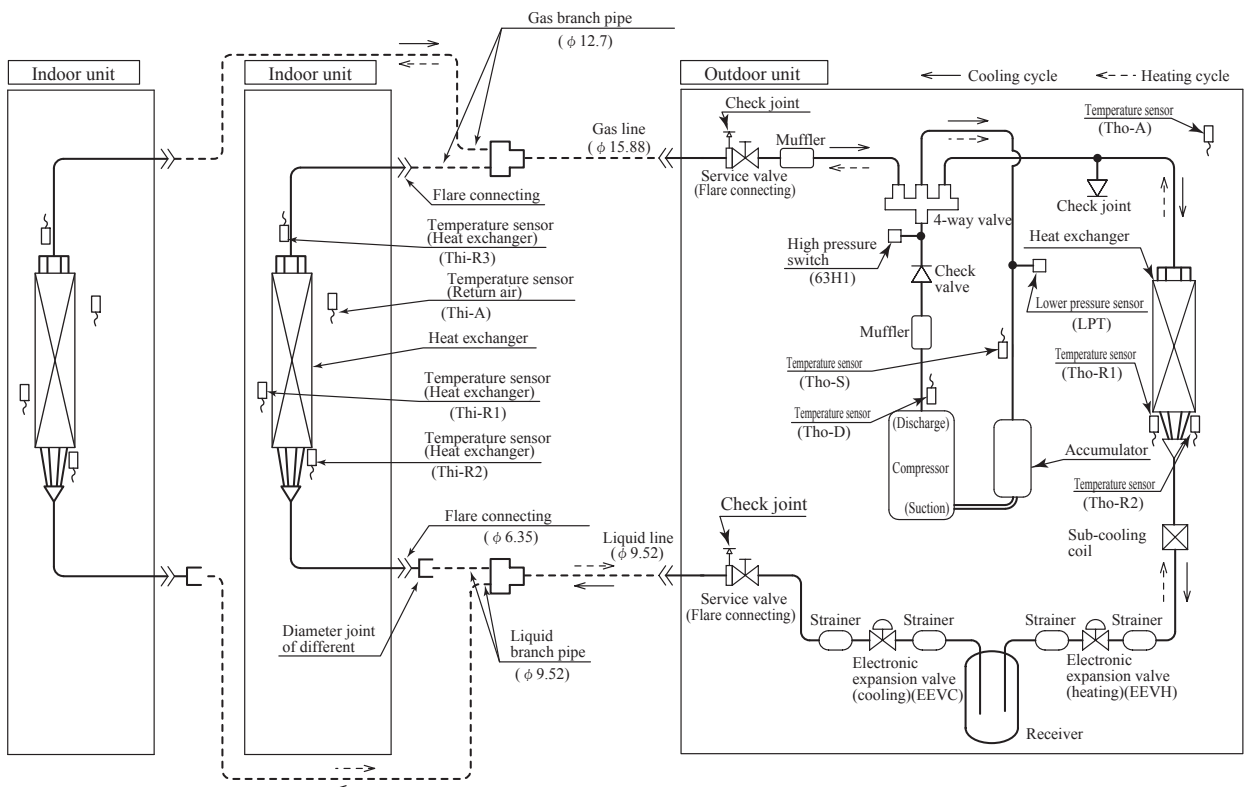

Preset point of the protective devices

Parts name	Mark	Equipped unit	71 model
Temperature sensor (for protection overloading in heating)	Thi-R	Indoor unit	OFF 63°C ON 56°C
Temperature sensor (for frost prevention)	Thi-R		OFF 1.0°C ON 10°C
Temperature sensor (for protection high pressure in cooling)	Tho-R	Outdoor unit	OFF 65°C ON 51°C
Temperature sensor (for detecting discharge pipe temperature)	Tho-D	Outdoor unit	OFF 115°C ON 85°C
High pressure switch (for protection)	63H1	Outdoor unit	OFF 4.15MPa ON 3.15MPa
Low pressure sensor (for protection)	LPT	Outdoor unit	OFF 0.079MPa ON 0.227MPa

(2) SRK series

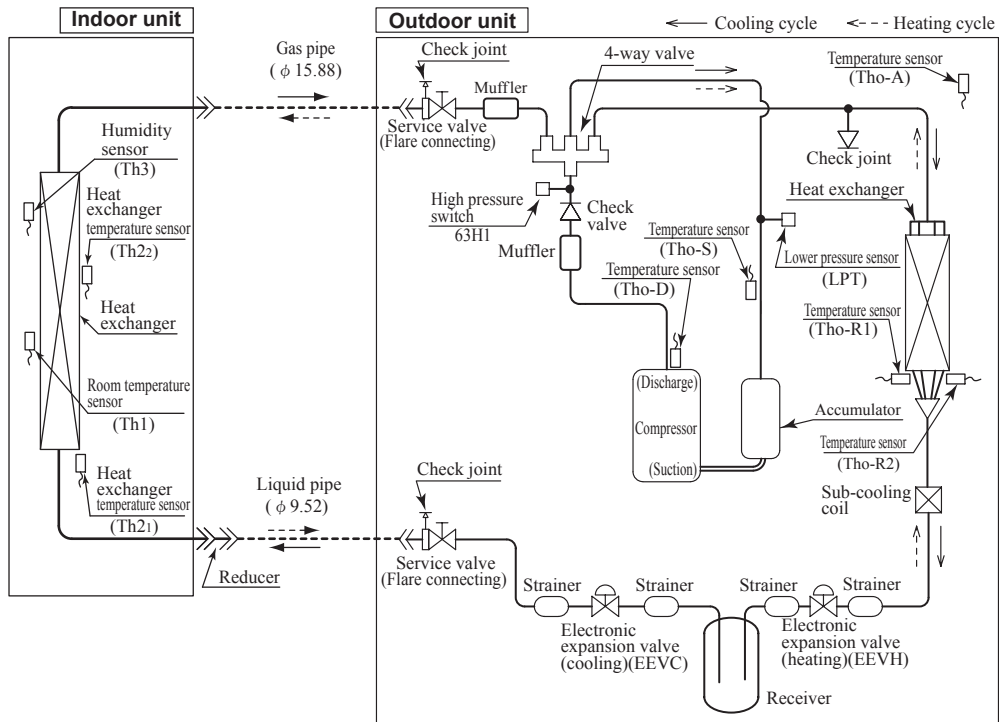

Preset point of the protective devices

Parts name	Mark	Equipped unit	SRK series
Temperature sensor (for protection overloading in heating)	Th2	Indoor unit	OFF 51.5-58°C , ON 43-45°C
Temperature sensor (for frost prevention)			OFF 2.5°C , ON 8°C
Temperature sensor (for protection high pressure in cooling)	Tho-R	Outdoor unit	OFF 65°C , ON 51°C
Temperature sensor (for detecting discharge pipe temperature)	Tho-D		OFF 115°C , ON 85°C
High pressure switch (for protection)	63H1		OFF 4.15Mpa , ON 3.15Mpa
Low pressure sensor (for protection)	LPT		OFF 0.079Mpa , ON 0.227Mpa

2. V MULTI SYSTEM

2.1 HYPER INVERTER PACKAGED AIR-CONDITIONERS

CONTENTS

2.1.1 OUTLINE OF OPERATION CONTROL BY MICROCOMPUTER ...	See page 4.
2.1.2 MAINTENANCE DATA	See page 50.
2.1.3 ELECTRICAL WIRING	See page 136.
2.1.4 PIPING SYSTEM	See page 144.

HYPER INVERTER PACKAGED AIR-CONDITIONERS



MITSUBISHI HEAVY INDUSTRIES THERMAL SYSTEMS, LTD.

2-3, Marunouchi 3-chome, Chiyoda-ku, Tokyo, 100-8332, Japan
<http://www.mhi-mth.co.jp/en/>

Because of our policy of continuous improvement, we reserve the right to make changes in all specifications without notice.

© Copyright MITSUBISHI HEAVY INDUSTRIES THERMAL SYSTEMS, LTD.