

Ver. | - -

„ORIGINAL INSTRUCTIONS“

IMPORTANT NOTE:

Read this manual carefully before installing or operating your new air conditioning unit. Make sure to save this manual for future reference.

EN

For downloading manual for this product, please enter the model name at this link:

**SK**

Pre stiahnutie manuálu k tomuto produktu zadajte modelové označenie do nasledujúceho odkazu:

**HR**

Za preuzimanje priručnika za ovaj proizvod unesite naziv modela na ovu vezu:

**SL**

Za prenos navodil za uporabo tega izdelka, vnesite ime modela na tej povezavi:

**IT**

Per scaricare il manuale di questo prodotto, inserisci il nome del modello a questo link:

**CZ**

Pro stažení manuálu k tomuto produktu zadejte modelové označení do následujícího odkazu:

**DE**

Um das Handbuch für dieses Produkt herunterzuladen, geben Sie bitte den Modellnamen für diesen Link ein:

**HU**

Termék kézikönyvének letöltéséhez írja be a modell megnevezését az alábbi linkre:

**RU**

Чтобы загрузить руководство для этого продукта, введите обозначение модели по следующей ссылке:

**ES**

Para descargar el manual de este producto, ingrese la designación del modelo en el siguiente enlace:



VERY IMPORTANT

Do not install and use your portable air conditioner unit before carefully reading this instruction guide. Please retain this manual brochure for product warranty and future reference

CAUTION

1. Do not use means to accelerate the defrosting process or to clean, other than those recommended by the manufacturer.
2. The appliance shall be stored in a room without continuously operating ignition sources (for example: open flames, an operating gas appliance or an operating electric heater.)
3. Do not pierce or burn.
4. Be aware that refrigerants may not contain an odour.
5. Appliance AMC-11P shall be installed, operated and stored in a room with a floor area larger than 12m^2 and AMC-14P larger than 13m^2 .
6. Servicing shall be performed only as recommended by the manufacturer.
7. The appliance shall be stored in a well-ventilated area where the room size corresponds to the room area as specified for operation.
8. All working procedure that affects safety means shall only be carried by competent persons.



caution, risk of fire



9. " PLEASE MAKE SURE THE PRODUCT VENTILATES ALL THE TIME " ! Please make sure the inlet and outlet ventilation is not blocked at all times.
10. Operate this unit on a horizontal surface to avoid water leakage.
11. Do not operate this unit in an explosive or corrosive atmosphere.
12. Operate this unit in an ambient of 35 degree centigrade or less.
13. The heating function of the unit should be operated in an indoor ambient temperature between 7°C and 23°C
14. Clean air filter periodically to enjoy the most efficient cooling.
15. When the unit is shut off, please wait at least 3.5 minutes before restarting this is to prevent the compressor from being damaged.
16. This unit needs at least 7 Amps of electricity to have its compressor operational. To avoid the household electricity block out, please do not use any extension cord for this unit.
17. This unit is for indoor cooling, heating and

dehumidifying.

18. When turning on the unit, the fan will operate but the compressor will start up after the cooling alarm flashes for three minutes
 - In heating function, the heating alarm will flash for 3.5 minutes before the compressor and fan start up.
19. When the supply cord is damaged, it must be replaced by the manufacturer, its service agent or similarly qualified persons in order to avoid hazard.
20. In order to dispose the appliance safely, please remove the batteries from the unit before scrapping it.
21. This appliance can be used by children aged from 8 years and above and persons with reduced physical, sensory or mental capabilities or lack of experience and knowledge if they have been given supervision or instruction concerning use of the appliance in a safe way and understand the hazards involved. Children shall not play with the appliance. Cleaning and user maintenance shall not be made by children without supervision.
22. The air-conditioner can be connected only to a supply with system impedance no more than 0.219Ω . In case necessary, please consult your supply authority for system impedance information.
23. The appliance shall be installed in accordance with

national wiring regulations.

24. Do not operate your air conditioner in a wet room such as a bathroom or laundry room. (Do not suitable for the model with window kit)

Transportation, marking and storage for units

1. Transport of equipment containing flammable refrigerants Compliance with the transport regulations
2. Marking of equipment using signs
Compliance with local regulations
3. Disposal of equipment using flammable refrigerants Compliance with national regulations
4. Storage of equipment/appliances The storage of equipment should be in accordance with the manufacturer's instructions.
5. Storage of packed (unsold) equipment
Storage package protection should be constructed such that mechanical damage to the equipment inside the package will not cause a leak of the refrigerant charge. The maximum number of pieces of equipment permitted to be stored together will be determined by local regulations.
6. The appliance shall be stored so as to prevent mechanical damage from occurring.
7. General work area All maintenance staff and

others working in the local area shall be instructed on the nature of work being carried out. Work in confined spaces shall be avoided. The area around the workspace shall be sectioned off. Ensure that the conditions within the area have been made safe by control of flammable material.

ATTENTION

For effective heating and cooling functions, please ensure that the following steps are undertaken:

- 1) Extend the exhaust hose to a length of not more than 400mm. The exhaust hose must be kept parallel and must not be bent up or down.
- 2) A distance of 500mm minimum must be kept between the filter side of the unit and wall or any other obstacles".
- 3) When this appliance starts to defrost, the word "DF" will be displayed on the LED

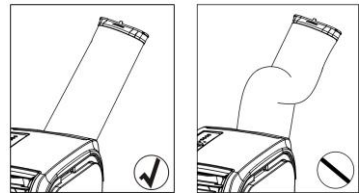
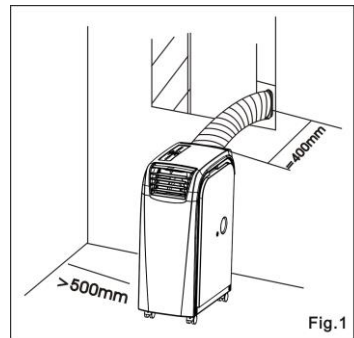

CONGRATULATIONS ON YOUR SELECTION OF A QUALITY PORTABLE AIR CONDITIONER

PORTABLE AIR CONDITIONER

This Air Conditioner has been designed and manufactured to the highest standards of modern engineering.

Our product not only provides you a remote control to help user operate all the functions easily and conveniently but also has below benefits:

- **Moves easily from room to room on easy glide castors**
- **No installation required-just plug into any household power outlet**
- **Powerful refrigerated air system cools down the ambience instantly whenever you want.**
- **Dehumidified and filtered air cycle improve breathing environments effectively.**
- **Besides the remote control, your one touch electronic pad also provides easy-identifying manual operation.**
- **24 hour programmable timer that can be used with either the air conditioning or dehumidification setting**
- **Unique sleep control function**
- **220-240 Volt 50Hz operation**
- **1.8 meter cord with plug**

UNPACKING INSTRUCTIONS

1. Place the unit in the correct upright position before unpacking.
2. Cut the two packing straps.
3. Slide the carton in an upwards motion and it will release from the base.
4. Grip the carry handles located on either sides of the unit and carefully lift until it slides out of the foam base.
5. Remove the air outlet and take out the exhaust hose as the picture.
6. Install the exhaust hose on the unit before operating the unit.

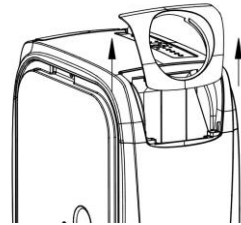

CONTENTS

- 1 / Air conditioner unit
- 2 / Remote control
- 3 / Batteries
- 4/ Window Kit A

NAME OF THE PARTS

1. Control panel
2. Remote control receiver
3. Adjustable air vent
4. Joint tube
5. Exhaust hose
6. Upside drain hole

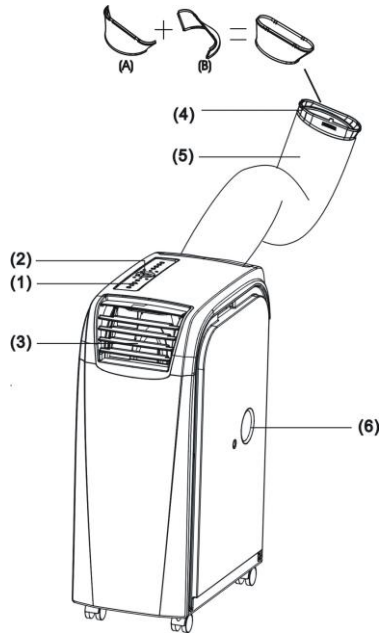

7. Cool air inlet
8. Cool air filter
9. Hot air inlet
10. Hot air filter
11. Downside drain hole

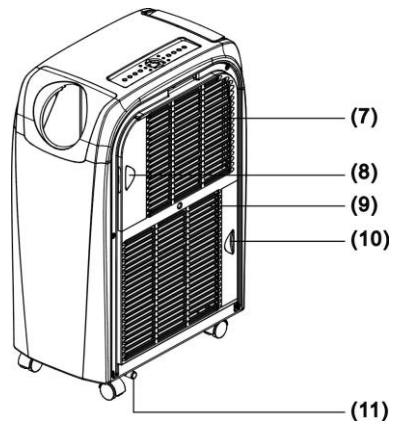

CONTROL PANEL & DESCRIPTION OF FUNCTION

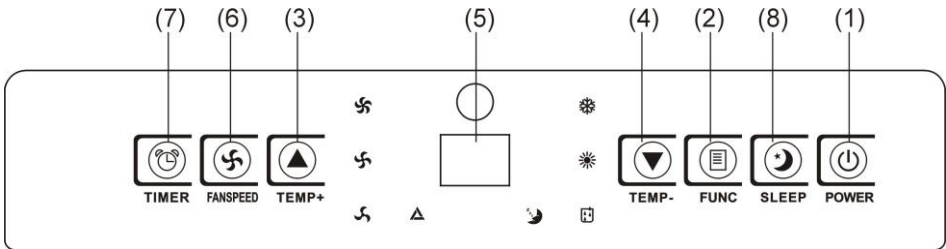

1. POWER KEY

Press to turn unit "ON" or "OFF".

2. FUNCTION

Press this key to select cooling, heating, or dehumidifying.

3. TEMPERATURE REGULATION KEY (UP)

During cooling function: This key raises the preset temperature by 1°C each time it is pressed and the maximum limit is 30°C.

During heating function: This key raises the preset temperature by 1°C each time it is pressed and the maximum limit is 25°C.

4. TEMPERATURE REGULATION KEY (DOWN)

During cooling function: This key lowers the preset temperature by 1°C each time it is pressed-and the minimum limit is 17°C.

During heating function: This key lowers the preset temperature by 1°C each time-and the minimum limit is 15°C.

5. L.E.D. DISPLAY

The display indicates the current setting temperature or the timer setting. When the set temperature or the timer is adjusted, the new setting is shown then the display returns the current set temperature.

✘ The display is also used to show error codes should a fault occur, see ERROR CODES.

6. SPEED

Press to select either LOW, MEDIUM, HIGH or AUTO fan speed.

If "AUTO" is selected, "HIGH" or "MEDIUM" or "LOW" will be selected automatically according to the difference between setting temperature and ambient temperature.

Note: In heating function and dehumidifying function, this key is invalid because the unit is **defined** to be high speed in heating mode and low speed in dehumidifying mode.

7. PROGRAMMABLE TIMER

Programmable timer ON/OFF key.

TIMER-ON: The timer-on is used to turn on the unit automatically after the set time is over.

1. Press the "TIMER" key at stand-by status to set the time you desired.
2. Once the set hour has come to an end, the unit will turn on automatically.
3. Press the "POWER" key before time out, the setting time will be canceled and the unit will turn on.
4. You can set the function and fan speed while setting the timer.

TIMER-OFF: The timer-off is used to turn off the unit automatically after the setting time is over.

1. Press the "TIMER" key at operating status to set the time you desired.
2. Once the set hour has come to an end, the unit will turn off automatically.
3. Press the "POWER" key before the time out, the setting time will be canceled and the unit will turn off.

8. SLEEP CONTROL FUNCTION

1. While in cooling mode, press the SLEEP key to set the temperature. It increases 1 °C after an hour and at most increases 2 °C after 2 hours.

2. While in heating mode, press the SLEEP key to set the temperature. It decreases 1 °C after an hour and at most decreases 2 °C after 2 hours.
3. Press the SLEEP key again can cancel the setting.

9. **ALARM**

When the water tank is full, "E4" will be displayed on the display panel. To resume operation, please remove the rubber cap of the drain hose to drain out the water firstly. The E4 warning will disappear after draining, and then you can restart the unit by pressing the POWER key.

REMOTE CONTROL FUNCTION

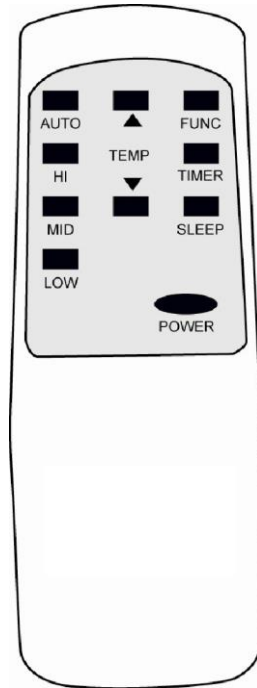

- 1. POWER
- 2. FUNC
- 3. TIMER
- 4. AUTO
- 5. HI
- 6. MID
- 7. LOW
- 8. SLEEP
- 9. TEMP.

- On/Off switch
- Function "MODE" selector
- Hourly programming
- Automatic fan speed
- High fan speed
- Medium fan speed
- Low fan speed
- Night operation selector
- Temperature selector

NOTICE

This unit can evaporate the condensation and distribute through the exhaust hose automatically.

1. When the unit is in the cooling function, it does not need the drain pipe installed.
Please make sure that the rubber cap is locked on drain hole, when the unit is running.
 2. When operating the heating function, the "①" rubber cap on drain hole should be pulled out and install a proper drain pipe in order to improve the heating effect
 3. When operating the dehumidifying function the "①" rubber cap on drain hose should be pulled out and install a proper drain hose.
- Please remove the air exhaust hose, connect a drain hose to the drain hole and lead the water to the outside in order to intensify dehumidifying capacity.
 - ※ When the water tank is full, "E4" will be displayed on the display panel. Please remove the rubber cap "②" of the drain hole to drain out the water first. After the drainage is completed, please restart the unit and then the unit can operate normally.

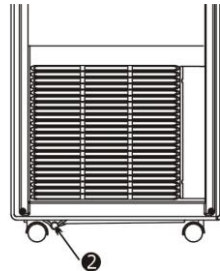
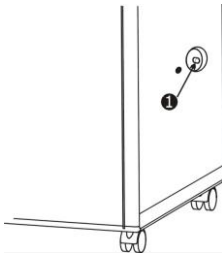

MAINTENANCE

PLEASE DISCONNECT THE POWER CORD BEFORE CLEANING.

AIR FILTER

The air filter located on the left hand side of the unit can be removed, simply by pulling the frame out

CONDENSER/EVAPORATOR

Use a brush attachment with a vacuum cleaner.

Casing

Wipe with a damp cloth and polish with a soft cloth.

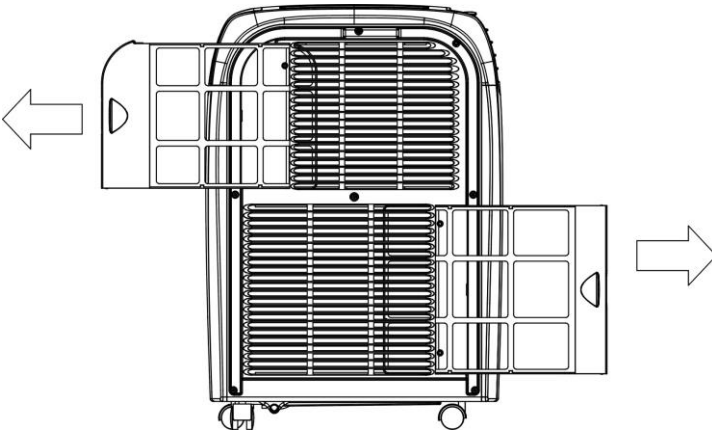

To remove the air filter, please follow the arrow direction and pull the filter lightly, and then take out the filter for cleaning.

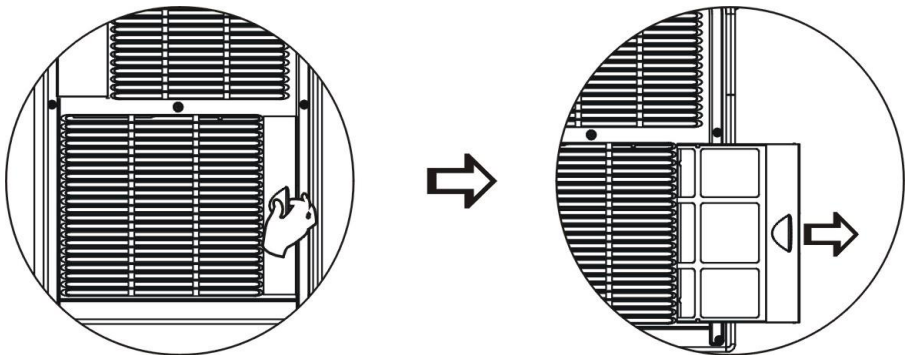

POWER SUPPLY

- (1) Confirm the correct power.
- (2) Insert the plug into the outlet firmly-In order to prevent any dangerous leakage.
- (3) Don't pull power wire by force because it will cause damage to power wire.



PLACE FOR USE

- (1) Because the machine distributes hot air, please don't place or operate in a narrow place.
- (2) In case of dangerous leak, don't work the machine in a humid place.
- (3) Don't place the machine in a sunlit corner otherwise the unit might shut down due to the overheat and the color of the machine may soon fade out.

HELPFUL HINTS

The unit is fitted with a special thermal cut off device.

Please ensure the unit is not placed against objects which will obstruct air intake e.g. furniture or curtains as this will affect it's performance dramatically.

EXHAUST HOSE INSTALL

1. Circumrotate the exhaust hose according to the direction as the arrowhead ① indicates and then the exhaust hose can be took out from the unit.
2. Circumrotate the exhaust hose according to the direction as the arrowhead ② indicates and then make it connect with the unit.

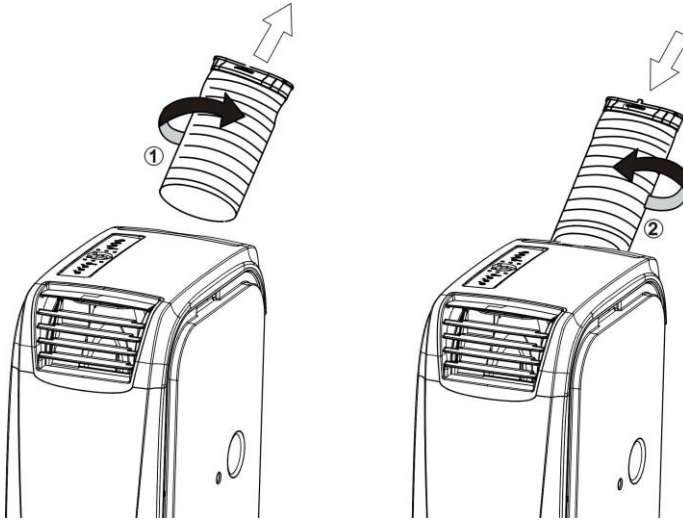

WINDOW KIT INSTALL

- ◆ Install the Exhaust Hose and the Adjustable Window Slider Kit as depicted in Fig.1 & Fig.1a.

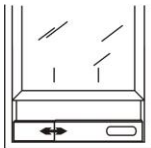

Window silder kit
min: 55cm
max: 100cm

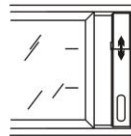
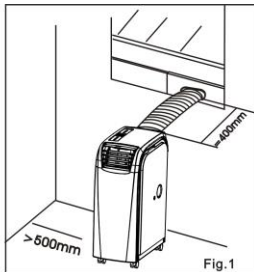

Window silder kit
min: 55cm
max: 100cm

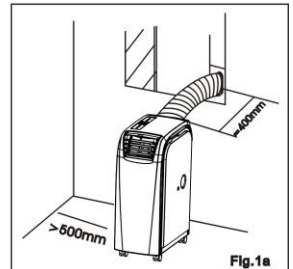

How to enjoy heating function?

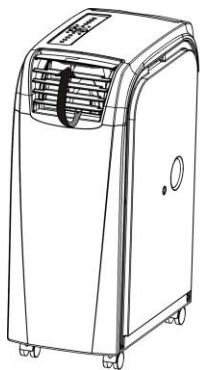

Fig.01

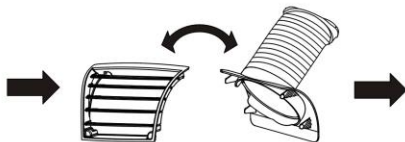

Fig.02

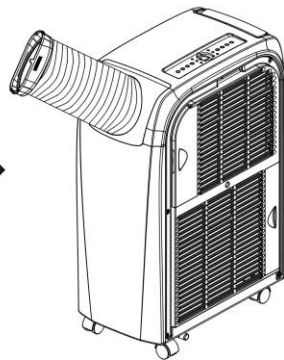

Fig.03

When operating heating function:

Disassemble the outlet and the exhaust hose as arrow direction in Fig.01 and then exchange the two subassemblies to install. The finished illustration is as Fig.03.

TROUBLESHOOTING

1. Information on servicing

1) Checks to the area

Prior to beginning work on systems containing flammable refrigerants, safety checks are necessary to ensure that the risk of ignition is minimised. For repair to the refrigerating system, the following precautions shall be complied with prior to conducting work on the system.

2) Work procedure

Work shall be undertaken under a controlled procedure so as to minimise the risk of a flammable gas or vapour being present while the work is being performed.

3) Checking for presence of refrigerant

The area shall be checked with an appropriate refrigerant detector prior to and during work, to ensure the technician is aware of potentially flammable atmospheres. Ensure that the leak detection equipment being used is suitable for use with flammable refrigerants, i.e. non-sparking, adequately sealed or intrinsically safe.

4) Presence of fire extinguisher

If any hot work is to be conducted on the refrigeration equipment or any associated parts, appropriate fire extinguishing equipment shall be available to hand. Have a dry powder or CO₂ fire extinguisher adjacent to the charging area.

5) No ignition sources

No person carrying out work in relation to a refrigeration system which involves exposing any pipe work that contains or has contained flammable refrigerant shall use any sources of ignition in such a manner that it may lead to the risk of fire or explosion. All possible ignition sources, including cigarette smoking, should be kept sufficiently far away from the site of installation, repairing, removing and disposal, during which flammable refrigerant can possibly be released to the surrounding space. Prior to work taking place, the area

around the equipment is to be surveyed to make sure that there are no flammable hazards or ignition risks. "No Smoking" signs shall be displayed.

6) Ventilated area

Ensure that the area is in the open or that it is adequately ventilated before breaking into the system or conducting any hot work. A degree of ventilation shall continue during the period that the work is carried out. The ventilation should safely disperse any released refrigerant and preferably expel it externally into the atmosphere.

7) Checks to the refrigeration equipment

Where electrical components are being changed, they shall be fit for the purpose and to the correct specification. At all times the manufacturer's maintenance and service guidelines shall be followed. If in doubt consult the manufacturer's technical department for assistance.

The following checks shall be applied to installations using flammable refrigerants:

- The charge size is in accordance with the room size within which the refrigerant containing parts are installed;
- The ventilation machinery and outlets are operating adequately and are not obstructed;
- If an indirect refrigerating circuit is being used, the secondary circuit shall be checked for the presence of refrigerant;
- Marking to the equipment continues to be visible and legible. Markings and signs that are illegible shall be corrected;
- Refrigeration pipe or components are installed in a position where they are unlikely to be exposed to any substance which may corrode refrigerant containing components, unless the components are constructed of materials which are inherently resistant to being corroded or are suitably protected against being so corroded.

8) Checks to electrical devices

Repair and maintenance to electrical components shall include initial safety checks and component inspection procedures. If a fault exists that could compromise safety, then no electrical supply shall be connected to the circuit until it is satisfactorily dealt with. If the fault cannot be corrected immediately but it is necessary to continue operation, an adequate temporary solution shall be used. This shall be reported to the owner of the equipment so all parties are advised.

Initial safety checks shall include:

- That capacitors are discharged: this shall be done in a safe manner to avoid possibility of sparking;
- That there no live electrical components and wiring are exposed while charging, recovering or purging the system;
- That there is continuity of earth bonding.

2. Repairs to sealed components

- 1) During repairs to sealed components, all electrical supplies shall be disconnected from the equipment being worked upon prior to any removal of sealed covers, etc. If it is absolutely necessary to have an electrical supply to equipment during servicing, then a permanently operating form of leak detection shall be located at the most critical point to warn of a potentially hazardous situation.
- 2) Particular attention shall be paid to the following to ensure that by working on electrical components, the casing is not altered in such a way that the level of protection is affected. This shall include damage to cables, excessive number of connections, terminals not made to original specification, damage to seals, incorrect fitting of glands, etc.

Ensure that apparatus is mounted securely.

Ensure that seals or sealing materials have not degraded such that they no longer serve the purpose of preventing the ingress of flammable atmospheres. Replacement

parts shall be in accordance with the manufacturer's specifications.

NOTE: The use of silicon sealant may inhibit the effectiveness of some types of leak detection equipment. Intrinsically safe components do not have to be isolated prior to working on them.

3. Repair to intrinsically safe components

Do not apply any permanent inductive or capacitance loads to the circuit without ensuring that this will not exceed the permissible voltage and current permitted for the equipment in use.

Intrinsically safe components are the only types that can be worked on while live in the presence of a flammable atmosphere. The test apparatus shall be at the correct rating. Replace components only with parts specified by the manufacturer. Other parts may result in the ignition of refrigerant in the atmosphere from a leak.

4. Cabling

Check that cabling will not be subject to wear, corrosion, excessive pressure, vibration, sharp edges or any other adverse environmental effects. The check shall also take into account the effects of aging or continual vibration from sources such as compressors or fans.

5. Detection of flammable refrigerants

Under no circumstances shall potential sources of ignition be used in the searching for or detection of refrigerant leaks. A halide torch (or any other detector using a naked flame) shall not be used.

6. Leak detection methods

The following leak detection methods are deemed acceptable for systems containing flammable refrigerants.

Electronic leak detectors shall be used to detect flammable refrigerants, but the sensitivity may not be adequate, or may need re-calibration. (Detection equipment shall be calibrated in a refrigerant-free area.) Ensure that the detector is not a potential source of ignition and is suitable for the refrigerant used. Leak detection

equipment shall be set at a percentage of the LFL of the refrigerant and shall be calibrated to the refrigerant employed and the appropriate percentage of gas (25 % maximum) is confirmed.

Leak detection fluids are suitable for use with most refrigerants but the use of detergents containing chlorine shall be avoided as the chlorine may react with the refrigerant and corrode the copper pipe-work.

If a leak is suspected, all naked flames shall be removed/ extinguished.

If a leakage of refrigerant is found which requires brazing, all of the refrigerant shall be recovered from the system, or isolated (by means of shut off valves) in a part of the system remote from the leak. Oxygen free nitrogen (OFN) shall then be purged through the system both before and during the brazing process.

7. Removal and evacuation

When breaking into the refrigerant circuit to make repairs – or for any other purpose –conventional procedures shall be used. However, it is important that best practice is followed since flammability is a consideration. The following procedure shall be adhered to:

- Remove refrigerant;
- Purge the circuit with inert gas;
- Evacuate;
- Purge again with inert gas;
- Open the circuit by cutting or brazing.

The refrigerant charge shall be recovered into the correct recovery cylinders. The system shall be “flushed” with OFN to render the unit safe. This process may need to be repeated several times. Compressed air or oxygen shall not be used for this task. Flushing shall be achieved by breaking the vacuum in the system with OFN and continuing to fill until the working pressure is achieved, then venting to atmosphere, and finally pulling down to a vacuum. This process shall be repeated until no refrigerant is within the system. When the final OFN charge is used, the

system shall be vented down to atmospheric pressure to enable work to take place. This operation is absolutely vital if brazing operations on the pipe-work are to take place. Ensure that the outlet for the vacuum pump is not close to any ignition sources and there is ventilation available.

8. Charging procedures

In addition to conventional charging procedures, the following requirements shall be followed.

- Ensure that contamination of different refrigerants does not occur when using charging equipment. Hoses or lines shall be as short as possible to minimise the amount of refrigerant contained in them.
- Cylinders shall be kept upright.
- Ensure that the refrigeration system is earthed prior to charging the system with refrigerant.
- Label the system when charging is complete (if not already).
- Extreme care shall be taken not to overfill the refrigeration system. Prior to recharging the system it shall be pressure tested with OFN. The system shall be leak tested on completion of charging but prior to commissioning. A follow up leak test shall be carried out prior to leaving the site.

9. Decommissioning

Before carrying out this procedure, it is essential that the technician is completely familiar with the equipment and all its detail. It is recommended good practice that all refrigerants are recovered safely. Prior to the task being carried out, an oil and refrigerant sample shall be taken in case analysis is required prior to re-use of reclaimed refrigerant. It is essential that electrical power is available before the task is commenced.

- a) Become familiar with the equipment and its operation.
- b) Isolate system electrically.
- c) Before attempting the procedure ensure that:

- Mechanical handling equipment is available, if required, for handling refrigerant cylinders;
 - All personal protective equipment is available and being used correctly;
 - The recovery process is supervised at all times by a competent person;
 - Recovery equipment and cylinders conform to the appropriate standards.
- d) Pump down refrigerant system, if possible.
- e) If a vacuum is not possible, make a manifold so that refrigerant can be removed from various parts of the system.
- f) Make sure that cylinder is situated on the scales before recovery takes place.
- g) Start the recovery machine and operate in accordance with manufacturer's instructions.
- h) Do not overfill cylinders. (No more than 80 % volume liquid charge).
- i) Do not exceed the maximum working pressure of the cylinder, even temporarily.
- j) When the cylinders have been filled correctly and the process completed, make sure that the cylinders and the equipment are removed from site promptly and all isolation valves on the equipment are closed off.
- k) Recovered refrigerant shall not be charged into another refrigeration system unless it has been cleaned and checked.

10. Labelling

Equipment shall be labelled stating that it has been de-commissioned and emptied of refrigerant. The label shall be dated and signed. Ensure that there are labels on the equipment stating the equipment contains flammable refrigerant.

11. Recovery

When removing refrigerant from a system, either for servicing or decommissioning, it is recommended good practice that all refrigerants are removed safely.

When transferring refrigerant into cylinders, ensure that only appropriate refrigerant recovery cylinders are employed. Ensure that the correct number of cylinders for holding the total system charge is available. All cylinders to be used

are designated for the recovered refrigerant and labelled for that refrigerant (i.e. special cylinders for the recovery of refrigerant). Cylinders shall be complete with pressure relief valve and associated shut-off valves in good working order. Empty recovery cylinders are evacuated and, if possible, cooled before recovery occurs. The recovery equipment shall be in good working order with a set of instructions concerning the equipment that is at hand and shall be suitable for the recovery of flammable refrigerants. In addition, a set of calibrated weighing scales shall be available and in good working order. Hoses shall be complete with leak-free disconnect couplings and in good condition. Before using the recovery machine, check that it is in satisfactory working order, has been properly maintained and that any associated electrical components are sealed to prevent ignition in the event of a refrigerant release. Consult manufacturer if in doubt.

The recovered refrigerant shall be returned to the refrigerant supplier in the correct recovery cylinder, and the relevant Waste Transfer Note arranged. Do not mix refrigerants in recovery units and especially not in cylinders.

If compressors or compressor oils are to be removed, ensure that they have been evacuated to an acceptable level to make certain that flammable refrigerant does not remain within the lubricant. The evacuation process shall be carried out prior to returning the compressor to the suppliers. Only electric heating to the compressor body shall be employed to accelerate this process. When oil is drained from a system, it shall be carried out safely.

Fuse parameters of the machine

Type: 5ET or SMT Voltage: 250V Current: 3.15 A

TROUBLE SHOOTING

Problem	Cause	Trouble shooting
E1	Electrical short on both temperature sensor and PCB	Contact an electrician for repair
E2	Electrical short of temperature sensor copper tube and PCB wiring	Contact an electrician for repair
E4	Indicates water tank full or possibly the incorrect wiring of plug	User needs to pull out the rubber stopper which is located at the bottom of the unit, to drain the water away. Check that the plug has been wired correctly.

Switch for Fahrenheit or Celsius

Solution

For Fahrenheit switching, please press function key for 10 s during the stand by mode.

DF

Defrosting protection mode

Compressor keep on working for 15 min. please check the fan coil temperature $\leq 1^{\circ}\text{C}$. thus compressor will be turned off. if the compressor stop for 3min&30s. Indoor fan coil temperature $> 2^{\circ}\text{C}$ compressor will be turned on and defrosting mode will be off.

ENERGY LABEL

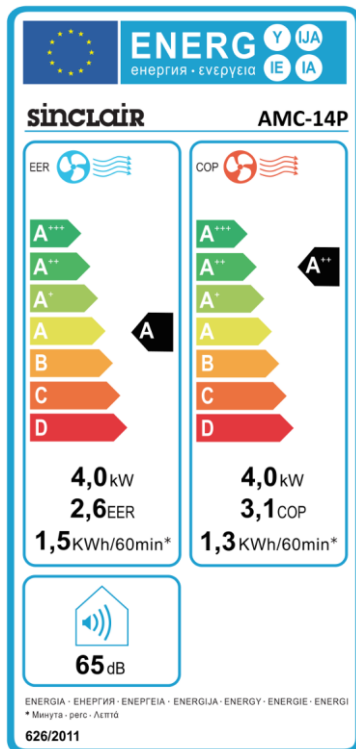

SPECIFICATION

Model	AMC-11P	AMC-14P
Power Source	220–240 V / 50 Hz	
Rated Power (EN60335)		
Cooling	1150 W	1535 W
Heating	965 W	1290 W
Cooling Capacity	3000 W	4000 W
Heating Capacity	3000 W	4000 W
Moisture Removed	50 liters/day	70 liters/day
Refrigerant	R290 / 0,23kg	R290 / 0,27kg
Allowable Pressure:		
Suction	0,6MPa (6Kgf/cm ²)	
Discharge	2,5MPa (25Kgf/cm ²)	
Maximum Allowable Pressure	4,0MPa (40Kgf/cm ²)	
Dimensions (mm)	300 (W) × 532 (D) × 760 (H)	



This marking indicates that this product should not be disposed with other household wastes throughout the EU. To prevent possible hazards to the environment or human health from uncontrolled waste disposal, please recycle it to prove the sustainable reuse of material resources. Please ask return and collection systems or contact the retailer where the product was purchased to return your used device, they can recycle products safely.

INFORMATION CONCERNING USED REFRIGERANT MEDIUM

Device is pre-filled with flammable R290 refrigerant. The maintenance and the liquidation must be carried out by qualified personnel.

Type of refrigerant: R290 (CH₃CH₂CH₃)

The quantity of the refrigerant: please see the unit label.

Hermetically sealed system.

The value GWP: 3

GWP = Global Warming Potential

In case of quality problem or other please contact your local supplier or authorized service center.

Emergency number: 112

NOTE CONCERNING PROTECTION OF ENVIRONMENT



This product must not be disposed of via normal household waste after its service life, but must be taken to a collection station for the recycling of electrical and electronic devices. The symbol on the product, the operating instructions or the packaging indicate such disposal procedures. The materials are recyclable in accordance with their respective symbols. By means of re-use, material recycling or any other form of recycling old appliances you are making an important contribution to the protection of our environment. Please ask your local council where your nearest disposal station is located.

INFORMATION CONCERNING USED REFRIGERANT MEDIUM

This unit is containing fluorinated gases included in the Kyoto protocol. The maintenance and the liquidation must be carried out by qualified personnel.

Type of refrigerant: R290

The quantity of the refrigerant: Please see the unit label.

The value GWP: 3

GWP = Global Warming Potential



Appliance filled with flammable gas R290.

In case of quality problem or other please contact your local supplier or authorized service center.

Emergency number: 112

PRODUCER

SINCLAIR CORPORATION Ltd.

16 Great Queen Street

WC2B 5AH London

United Kingdom

www.sinclair-world.com

This product was manufactured in China (Made in China).

REPRESENTATIVE

SINCLAIR Global Group s.r.o.

Purkynova 45

612 00 Brno

Czech Republic

TECHNICAL SUPPORT

SINCLAIR Global Group s.r.o.

Purkynova 45

612 00 Brno

Czech Republic

Tel.: +420 800 100 285 | Fax: +420 541 590 124

www.sinclair-solutions.com | info@sinclair-solutions.com



EN

For downloading manual for this product, please enter the model name at this link:

**SK**

Pre stiahnutie manuálu k tomuto produktu zadajte modelové označenie do nasledujúceho odkazu:

**HR**

Za preuzimanje priručnika za ovaj proizvod unesite naziv modela na ovu vezu:

**SL**

Za prenos navodil za uporabo tega izdelka, vnesite ime modela na tej povezavi:

**IT**

Per scaricare il manuale di questo prodotto, inserisci il nome del modello a questo link:

**CZ**

Pro stažení manuálu k tomuto produktu zadejte modelové označení do následujícího odkazu:

**DE**

Um das Handbuch für dieses Produkt herunterzuladen, geben Sie bitte den Modellnamen für diesen Link ein:

**HU**

Termék kézikönyvének letöltéséhez írja be a modell megnevezését az alábbi linkre:

**RU**

Чтобы загрузить руководство для этого продукта, введите обозначение модели по следующей ссылке:

**ES**

Para descargar el manual de este producto, ingrese la designación del modelo en el siguiente enlace:





sinclair

AIR CONDITIONING