

# 8. APPLICATION DATA

## (1) Installation of indoor unit

RLF012A111

Model SRK15,20,25,35,50ZS-WF  
R32/R410A REFRIGERANT USED

- This installation manual deals with an indoor unit installation only. For an outdoor unit installation, refer to page 51.
- This unit is designed for R32 or R410A. See a label on the outdoor unit to check refrigerant information.

### SAFETY PRECAUTIONS

- Before installation, read the "SAFETY PRECAUTIONS" carefully and strictly follow it during the installation work in order to protect yourself.
- The precautionary items mentioned below are distinguished into two levels, **⚠ WARNING** and **⚠ CAUTION**.
  - ⚠ WARNING** Indicates a potentially hazardous situation which, if not avoided, can result in serious consequences such as death or severe injury.
  - ⚠ CAUTION** Indicates a potentially hazardous situation which, if not avoided, can result in personal injury or property damage.
- Both mention the important items to protect your health and safety. Therefore, strictly follow them by any means.
- Be sure to confirm no operation problem on the equipment after completing the installation. If unusual noise can be heard during the test run, consult the dealer.
- Be sure to explain the operating methods as well as the maintenance methods of this equipment to the user according to the user's manual.
- Be sure to keep the installation manual together with user's manual at a place where it is easily accessible to the user any time. Moreover, ask the user to hand the manuals to a new user, whenever required.









### ⚠ WARNING

- **Be sure to use only for residential purpose.**  
If this unit is installed in inferior environment such as machine shop, vehicle (like ship), warehouse, etc., it can malfunction.
- **Installation must be carried out by the qualified installer completely in accordance with the installation manual.**  
Installation by an unqualified person or incorrect installation can cause serious troubles such as water leak, electric shock, fire and personal injury.
- **Be sure to wear protective goggles and gloves while performing installation work.**  
Improper safety measures can result in personal injury.
- **Use the original accessories and the specified components for the installation.**  
Using parts other than those prescribed may cause water leak, electric shock, fire and personal injury.
- **Do not install the unit near the location where leakage of flammable gases can occur.**  
If leaked gases accumulate around the unit, it can cause fire resulting in property damage and personal injury.
- **When installing the unit in small rooms, make sure that refrigerant density does not exceed the limit (Reference: ISO5149) in the event of leakage.**  
If refrigerant density exceeds the limit, consult the dealer and install the ventilation system. Otherwise lack of oxygen can occur resulting in serious accident.
- **Install the unit in a location where unit will remain stable, horizontal and free of any vibration transmission.**  
Unsuitable installation location can cause the unit to fall resulting in material damage and personal injury.
- **Do not run the unit with removed panels or protections.**  
Touching rotating equipment, hot surfaces or high voltage parts can cause personal injury due to entrapment, burn or electric shock.
- **This unit is designed specifically for R32 or R410A.**  
Using any other refrigerant can cause unit failure and personal injury.
- **Do not vent R32 or R410A into atmosphere.**  
R32 is a fluorinated greenhouse gas with a Global Warming Potential (GWP) = 675.  
R410A is a fluorinated greenhouse gas with a Global Warming Potential (GWP) = 2088.
- **Make sure that no air enters the refrigerant circuit when the unit is installed and removed.**  
If air enters the refrigerant circuit, the pressure in the refrigerant circuit will become too high, which can cause burst and personal injury.
- **Be sure to use the prescribed pipes, flare nuts and tools for R32 or R410A.**  
Using existing parts (for R22 or R407C) can cause refrigerant circuit burst resulting in unit failure and personal injury.
- **Be sure to connect both liquid and gas connecting pipes properly before operating the compressor.**  
**Do not open the liquid and gas service valves before completing piping work, and evacuation.**  
If the compressor is operated when connecting pipes are not connected and service valves are open, air can be sucked into the refrigerant circuit which can cause anomalous high pressure resulting in burst or personal injury.
- **Be sure to tighten the flare nuts to specified torque using the torque wrench.**  
Tightening flare nuts with excess torque can cause burst and refrigerant leakage after a long period.
- **During pump down work, be sure to stop the compressor before closing service valves and removing connecting pipes.**  
If the connecting pipes are removed when the compressor is in operation and service valves are open, air can be sucked into the refrigerant circuit which can cause anomalous high pressure resulting in burst or personal injury.
- **In the event of refrigerant leakage during installation, be sure to ventilate the working area properly.**  
If the refrigerant comes into contact with naked flames, poisonous gases will be produced.
- **Electrical work must be carried out by the qualified electrician, strictly in accordance with national or regional electricity regulations.**  
Incorrect installation can cause electric shock, fire or personal injury.
- **Make sure that earth leakage breaker and circuit breaker of appropriate capacities are installed.**  
Circuit breaker should be able to disconnect all poles under over current. Absence of appropriate breakers can cause electric shock, personal injury or property damage.
- **Be sure to switch off the power source in the event of installation, maintenance or service.**  
If the power source is not switched off, there is a risk of electric shock, unit failure or personal injury.
- **Be sure to tighten the cables securely in terminal block and relieve the cables properly to prevent overloading the terminal blocks.**  
Loose connections or cable mountings can cause anomalous heat production or fire.
- **Do not process, splice or modify the power cable, or share the socket with other power plugs.**  
Improper power cable or power plug can cause fire or electric shock due to poor connection, insufficient insulation or over-current.
- **Do not perform any change in protective device or its setup condition yourself.**  
Changing protective device specifications can cause electric shock, fire or burst.
- **Be sure to clamp the cables properly so that they do not touch any internal component of the unit.**  
If cables touch any internal component, it can cause overheating and fire.
- **Be sure to install service cover properly.**  
Improper installation can cause electric shock or fire due to intrusion of dust or water.
- **Be sure to use the prescribed power and connecting cables for electrical work.**  
Using improper cables can cause electric leak or fire.
- **This appliance must be connected to main power source by means of a circuit breaker or switch with a contact separation of at least 3 mm.**  
Improper electrical work can cause unit failure or personal injury.
- **Be sure to connect the power source cable with power source properly.**  
Improper connection can cause intrusion of dust or water resulting in electric shock or fire.
- **Do not turn ON the wireless LAN communication near automatic control equipment such as an automatic door or fire-alarm device.**  
It may cause an accident due to malfunction of equipment.
- **Do not turn ON the wireless LAN communication in a hospital, etc. where the use of wireless devices is prohibited.**  
It may cause malfunction of medical equipment due to a wireless device.
- **Do not turn ON the wireless LAN communication near a person with a cardiac pacemaker or implanted defibrillator.**  
It may cause malfunction of a medical device.

### ⚠ CAUTION

- **Take care when carrying the unit by hand.**  
If the unit weight is more than 20 kg, it must be carried by two or more persons. Do not carry the unit by the plastic straps. Always use the carry handle.
- **Do not install the outdoor unit in a location where insects and small animals can inhabit.**  
Insects and small animals can enter the electrical parts and cause damage resulting in fire or personal injury. Instruct the user to keep the surroundings clean.
- **If the outdoor unit is installed at height, make sure that there is enough space for installation, maintenance and service.**  
Insufficient space can result in personal injury due to falling from the height.
- **Do not install the unit near the location where neighbours are bothered by noise or air generating from the unit.**  
It can affect surrounding environment and cause a claim.
- **Do not install in the locations where unit is directly exposed to corrosive gases (like sulphide gas, chloride gas), sea breeze or salty atmosphere.**  
It can cause corrosion of heat exchanger and damage to plastic parts.
- **Do not install the unit close to the equipment that generates electromagnetic waves and/or high-harmonic waves.**  
Equipment such as inverters, standby generators, medical high frequency equipment and telecommunication equipment can affect the system, and cause malfunctions and breakdowns. The system can also affect medical equipment and telecommunication equipment, and obstruct its function or cause jamming.
- **Do not turn ON the wireless LAN communication near another wireless device, microwave, cordless phone, fax machine, etc.**  
It may cause malfunction of wireless device.
- **Do not install the unit in the locations where:**
  - There are heat sources nearby.
  - Unit is directly exposed to rain or sunlight.
  - There is any obstacle which can prevent smooth air circulation from inlet and outlet side of the unit.
  - Unit is directly exposed to oil mist and steam such as kitchen.
  - Chemical substances like ammonia (organic fertilizer), calcium chloride (snow melting agent) and acid (sulfurous acid etc.), which can harm the unit, will generate or accumulate.
  - Drain water cannot be discharged properly.
  - TV set or radio receiver is placed within 1 m.
  - Height above sea level is more than 1000 m.
- **Dispose of all packing materials properly.**  
Packing materials contain nails and wood which can cause personal injury. Keep the polybag away from children to avoid the risk of suffocation.
- **Do not put anything on the outdoor unit.**  
Object may fall causing property damage or personal injury.
- **Do not touch the aluminum fin of the outdoor unit.**  
Aluminum fin temperature is high during heating operation. Touching fin can cause burn.
- **Do not touch any refrigerant pipe with your hands when the system is in operation.**  
During operation the refrigerant pipes become extremely hot or extremely cold depending on the operating condition. Touching pipes can cause personal injury like burn (hot/cold).
- **Install isolator or disconnect switch on the power source wiring in accordance with the local codes and regulations.**  
The isolator should be locked in OFF state in accordance with EN60204-1.

## 1. ACCESSORIES AND TOOLS

Standard accessories (supplied with indoor unit)		Locally procured parts		Tools for installation Work		
(1) Installation board	 1 pc.	(6) Batteries [R03 (AAA, Micro) 1.5 V]	 2 pcs.	(a) Sleeve (1 pc.)	Phillips headed driver	Pipe cutter
(2) Remote control	 1 pc.	(7) Air-cleaning filters	 2 pcs.	(b) Sealing plate (1 pc.)	Knife	Hole core drill (65 mm in diameter)
(3) Remote control holder	 1 pc.	(8) Filter holders	 2 pcs.	(c) Inclination plate (1 pc.)	Saw	Wrench key (Hexagon) [4mm]
(4) Tapping screws (for installation board φ4 X 25mm)	 5 pcs.	(9) Insulation (#486 50 X 100 t3)	 1 pc.	(d) Putty	Tape measure	Flaring tool set*
(5) Wood screws (for remote control holder φ3.5 X 16mm)	 2 pcs.			(e) Connecting cable	Torque wrench (14.0-62.0 N·m (1.4-6.2 kgf·m))	Gas leak detector*
				(f) Drain hose (extension hose)		Pipe bender
				(g) Piping cover (for insulation of connection piping)		Flare adjustment gauge
				(h) Clamp and screw (for finishing work)		
				(i) Electrical tape		

\* Designed specifically for R32 or R410A

## 2. SELECTING INSTALLATION LOCATION

After getting customer's approval, select installation location according to following guidelines.

### 1. Indoor unit

- Where there is no obstruction to the air flow and where the cooled and heated air can be evenly distributed.
- A solid place where the unit or the wall will not vibrate.
- A place where there will be enough space for servicing. (Where space mentioned on the right side can be secured.)
- Where it is easy to conduct wiring and piping work.
- A place where unit is not directly exposed to sunlight or street light.
- A place where it can be easily drained.
- A place separated at least 1 m away from the television or the radio. (To prevent interference to images and sounds.)
- A place where this unit is not affected by the high frequency equipment or electric equipment.
- Avoid installing this unit in place where there is much oil mist.
- A place where there is no electric equipment or household.
- Install the indoor unit on the wall where the height from the floor to the bottom of the unit is more than 180 cm.
- A place where the radio waves can reach when using the wireless LAN communication.

### 2. Remote control

- A place where the air-conditioner can receive the signal surely during operating the remote control.
- A place where it is not affected by the TV, radio etc.
- Do not place where it is exposed to direct sunlight or near heat devices such as a stove.

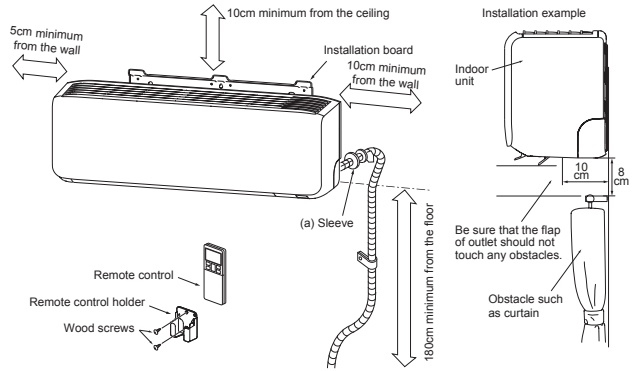

## 3. INSTALLING INSTALLATION BOARD

- Installation board should be installed on the wall which can support the weight of the indoor unit.
- Adjustment of the installation board in the horizontal direction is to be conducted with five screws in a temporary tightened state.
- With the standard hole as a center, adjust the board and level it.

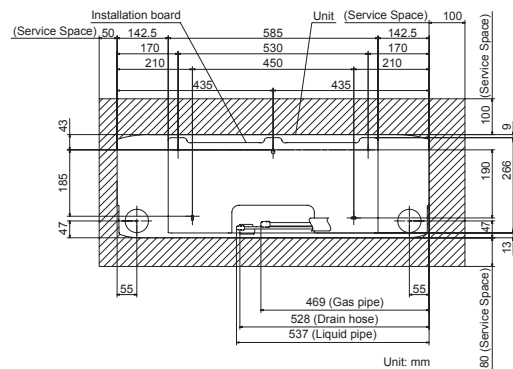
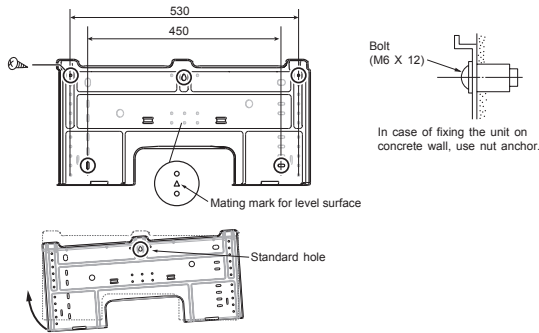

**CAUTION**  
Improper adjustment of the installation board can cause water leakage.

## 4. DRILLING HOLE AND FIXTURE OF SLEEVE

When drilling the wall that contains a metal lath, wire lath or metal plate, be sure to use sealing plate, sleeve and inclination plate (Locally procured parts).

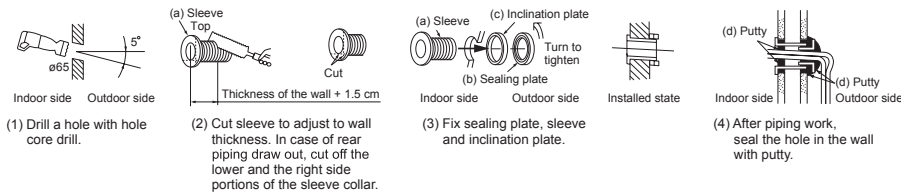

**WARNING**  
Completely seal the hole in the wall with putty. If not sealed properly, dust, insects, small animals, and highly humid air may enter the room from outside, which could result in fire or other hazards.

**CAUTION**  
Completely seal the hole in the wall with putty. If not sealed properly, furniture and other fixtures may be damaged by water leakage or condensation.

## 5. ELECTRICAL WIRING WORK

- Before installation, make sure that the power source complies with the air-conditioner's power specification.
- Carry out electrical wiring work according to following guidelines.

### 1. Preparing cable

- (1) Selecting cable  
Select the connecting cable in accordance with the specifications mentioned below.  
4 cores\* 1.5mm<sup>2</sup> conformed with 60245 IEC57  
\* 1 Earth wire is included (Yellow/Green).
- (2) Arrange each wire length as shown below.  
Make sure that each wire is stripped 10mm from the end.

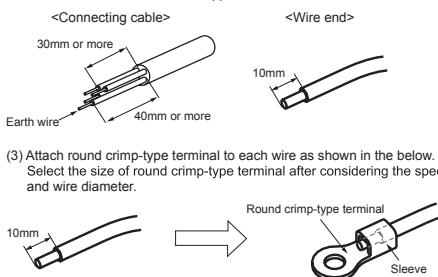

- (3) Attach round crimp-type terminal to each wire as shown in the below.  
Select the size of round crimp-type terminal after considering the specifications of terminal block and wire diameter.

### 2. Connecting cable

- (1) Open the air inlet panel.
- (2) Remove the lid.
- (3) Remove the cable clamp.
- (4) Connect the connecting wires to the terminal block.
- (5) Fix the connecting cable by cable clamp.
- (6) Fix the lid.
- (7) Close the air inlet panel.

### NOTE

Take care not to confuse the terminal numbers for indoor and outdoor connections.

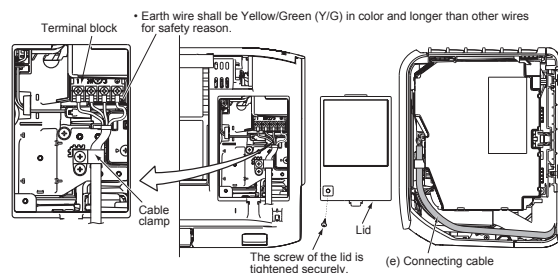

**WARNING**  
Incorrect wiring connection can cause malfunction or fire.

## 6. FORMING PIPING AND DRAIN HOSE

### 1. Forming piping

Piping is possible in the right, rear, downward, left, left rear or left downward direction.

#### NOTE

Sufficient care must be taken not to damage the panels when connecting pipes.

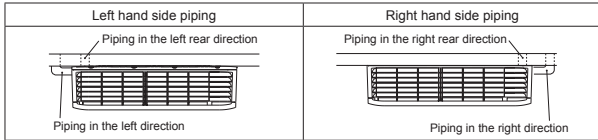
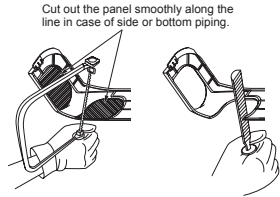
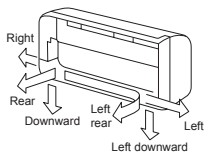

### Forming of piping.

- Hold the bottom of the piping and fix direction before stretching it and shaping it.

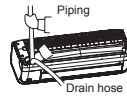

### Taping of the exterior

- Tape only the portion that goes through the wall.
- Always tape the wiring with the piping.



### 2. Drain change procedures

- Remove the screw and drain hose.
- Remove the drain cap by hand or pliers.
- Insert the drain cap which was removed at procedure (2) securely using a hexagonal wrench etc.
- Install the drain hose and screw securely.

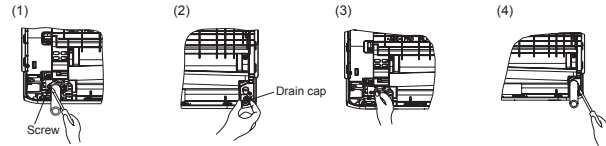

#### CAUTION

Incorrect installation of drain hose and cap can cause water leakage.

## 7. DRAINAGE WORK

- Arrange the drain hose in a downward angle.
- Avoid the following drain piping.

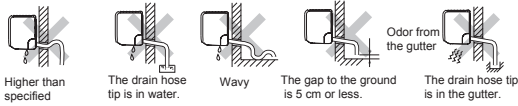

- Pour water to the drain pan located under the heat exchanger, and ensure that the water is discharged outdoor.
- When extended drain hose is present inside the room, insulate it securely with heat insulator available in the market.

Since this air-conditioner is designed to collect dew drops on the rear surface to the drain pan, do not install the connecting wire above the gutter.

#### CAUTION

Incorrect drainage work can cause water leakage.

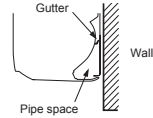

## 8. INSTALLING INDOOR UNIT

### Installing the indoor unit to installation board

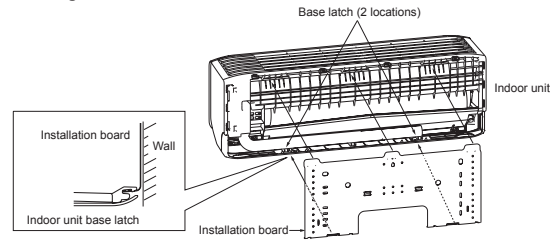

- Pass the pipe through the hole in the wall, and hook the upper part of the indoor unit to the installation board.



- Gently push the lower part to fix the indoor unit base lower latch to installation board.



### Removing the indoor unit from installation board

- Push up at the marked portion of the indoor unit base latch, and slightly pull it toward you (both right and left hand sides). (The indoor unit base latch can be removed from the installation board.)
- Push up the indoor unit upward so that it can be removed from installation board.

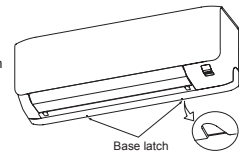

## 9. CONNECTING PIPING WORK

### 1. Preparation of connecting pipe

#### 1.1 Selecting connecting pipe

Select connecting pipe according to the following table.

	Model SRK15/20/25/35	Model SRK50
Gas pipe	φ9.52	φ12.7
Liquid pipe	φ6.35	φ6.35

- Pipe wall thickness must be greater than or equal to 0.8 mm.
- Pipe material must be O-type (Phosphorus deoxidized seamless copper pipe ICS 23.040.15, ICS 77.150.30).

#### 1.2 Cutting connecting pipe

- Cut the connecting pipe to the required length with pipe cutter.
- Hold the pipe downward and remove the burrs. Make sure that no foreign material enters the pipe.
- Cover the connecting pipe ends with the tape.

### 2. Piping work

#### 2.1 Flaring pipe

- Take out flare nuts from the operation valves of indoor unit and engage them onto connecting pipes.
- Flare the pipes according to table and figure shown below.  
Flare dimensions for R32 are different from those for conventional refrigerant. Although it is recommended to use the flaring tools designed specifically for R32 or R410A, conventional flaring tools can also be used by adjusting the dimension B with a flare adjustment gauge.

Copper pipe outer diameter	A	B [Rigid (clutch) type]	
		R32 or R410A	Conventional
φ6.35	9.1		
φ9.52	13.2		
φ12.7	16.6		

#### 2.2 Connecting pipes

- Connect pipes on both liquid and gas sides.
- Tighten nuts to specified torque shown in the table below.

Operation valve size (mm)	Tightening torque (N·m)
φ6.35 (1/4")	14-18
φ9.52 (3/8")	34-42
φ12.7 (1/2")	49-61

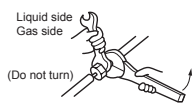

### 3. Heating and condensation prevention

- Dress the connecting pipe (both liquid and gas pipes) with insulation to prevent it from heating and dew condensation. Use the heat insulating material which can withstand 120 °C or higher temperature. Make sure that insulation is wrapped tightly around the pipes and no gap is left between them.
- Wrap the refrigerant pipings of indoor unit with indoor unit heat insulation using tape.
- Cover the flare-connected joints (indoor side) with the indoor unit heat insulation and wrap it with an insulation pad (standard accessory provided with indoor unit).
- Wrap the connecting pipes, connecting cable and drain hose with the tape.

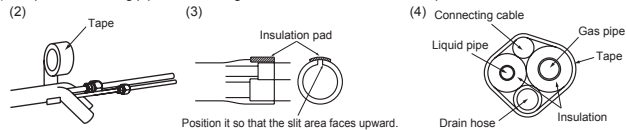

#### NOTE

Locations where relative humidity exceeds 70 %, both liquid and gas pipes need to be dressed with 20 mm or thicker heat insulation materials.

#### CAUTION

- Improper insulation can cause condensate(water) formation during cooling operation. Condensate can leak or drip causing damage to household property.
- Poor heat insulating capacity can cause pipe outer surface to reach high temperature during heating operation. It can cause cable deterioration and personal injury.

### 4. Finishing work

- Make sure that the exterior portion of connecting pipes, connecting cable and drain hose is wrapped properly with tape. Shape the connecting pipes to match with the contours of the pipe assembly route.
- Fix the pipe assembly with the wall using clamps and screws. Pipe assembly should be anchored every 1.5 m or less to isolate the vibration.
- Install the service cover securely. Water may enter the unit if service cover is not installed properly, resulting in unit malfunction and failure.

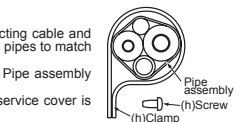

#### WARNING (only for R32)

- To avoid the risk of fire or explosion, the flared connection must/shall be installed outdoors.
- Reusable mechanical connectors and flared joints are not allowed indoors.

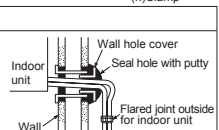

#### CAUTION

Make sure that the connecting pipes do not touch the components within the unit. If pipes touch the internal components, it may generate abnormal sounds and/or vibrations.

### 10. HOW TO OPEN, CLOSE, REMOVE AND INSTALL THE AIR INLET PANEL

#### 1. Open

Pull the air inlet panel at both ends of lower part and release latches, then pull up the panel until you feel resistance. (The panel stops at approx. 70° open position)

#### 2. Close

Hold the panel at both ends of lower part, lower it downward slowly, then push it slightly until the latch works.

#### 3. Removing

Open the panel by 90° (as shown in the right illustration) and then pull it forward.

#### 4. Installing

Insert the panel arm into the slot on the front panel from the position shown in right illustration, hold the panel at both ends of lower part, lower it downward slowly, then push it slightly until the latch works.

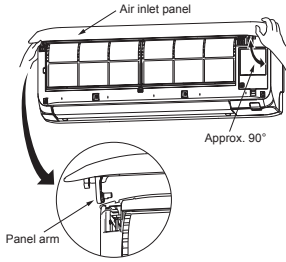

### 11. HOW TO REMOVE AND INSTALL THE BOTTOM AND FRONT PANEL

#### 1. Bottom panel

##### 1.1 Removing

- (1) Remove the 2 screws (in the cap).
- (2) Remove the 2 hooks of left and right side and then bottom panel can be removed.

##### 1.2 Installing

- (1) Install the 2 hooks of left and right side.
- (2) Secure the bottom panel with the 2 screws (in the cap).

#### 2. Front panel

##### 2.1 Removing

- (1) Remove the air inlet panel, the air filters and the bottom panel.
- (2) Remove the 2 screws.
- (3) Remove the 4 upper latches and then front panel can be removed.

##### 2.2 Installing

- (1) Cover the unit with the front panel and fix 4 upper latches.
- (2) Secure the front panel with the 2 screws.
- (3) Install the bottom panel, the air inlet panel and the air filters.

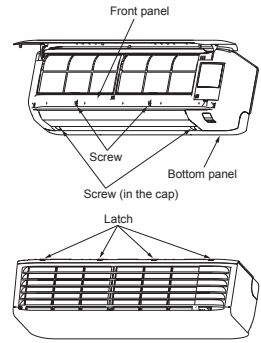

### 12. INSTALLING REMOTE CONTROL

#### Mount the batteries

- (1) Slide and take out the cover of backside.
- (2) Mount the batteries [R03 (AAA, Micro), x2 pieces] in the body properly. (Fit the poles with the indication marks + & -)
- (3) Set the cover again.

#### NOTE

- Do not use new and old batteries together.
- In case the unit is not operated for a long time, take out the batteries

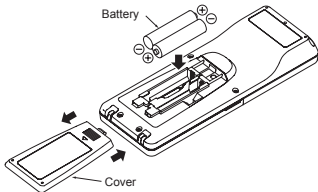

#### Installing remote control holder

- (1) Select the place where the unit can receive signals.
- (2) Fix the holder to pillar or wall with wood screws.

- Do not mix old and new batteries, or batteries of different types (manganese/alkaline).

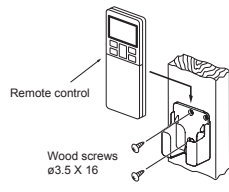

### 14. INSTALLING TWO AIR-CONDITIONERS IN THE SAME ROOM

In case two air-conditioners are installed in the same room, apply this setting so that one unit can be operated with only one remote control.

#### Setting one remote control

- (1) Slide and take out the cover and batteries.
- (2) Cut the switching line next to the battery with wire cutters.
- (3) Set the batteries and cover again.

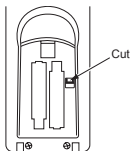

#### Setting one indoor unit

- (1) Turn off the power source and turn it on after 1 minute.
- (2) Send the signal by pressing the ACL switch on the remote control that was set according to the procedure described on the left side.
- (3) Check that the reception buzzer sound "Peep" is emitted from the indoor unit. Since the signal is sent about 6 seconds after the ACL switch is pressed, point the remote control to the indoor unit for a while.

#### NOTE

If no reception buzzer is emitted, restart the setting from the beginning.

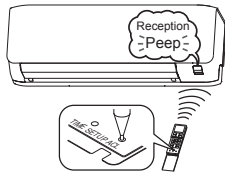

### 13. TERMINAL CONNECTION FOR AN INTERFACE

This unit is standardly equipped with a wireless LAN adapter. To install wired remote control, Superlink etc., interface kit is needed. When using the interface kit, the wireless LAN function cannot be used.

- (1) Turn off the power source.
- (2) Remove the air inlet panel, bottom panel and front panel.
- (3) Remove the control cover. (Remove the screw.)
- (4) There is a terminal (respectively marked with CNS) on the indoor unit PCB. Disconnect the harness from the CNS terminal.

Remove the wireless LAN adapter from the control box, and pull out the wireless LAN adapter harness from the wireless LAN adapter.

After that, install the wireless LAN adapter in the control box. While connecting an interface, connect to the CNS terminal securely with the connection harness supplied with an option "Interface connection kit SC-BIKN2-E" and fasten the connection harness onto the indoor control box with the clamp and screw supplied with the kit. For more details, refer to the user's manual of "Interface connection kit SC-BIKN2-E".

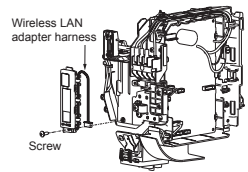
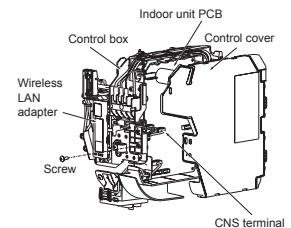

#### NOTE

Make sure that the disconnected connector does not touch the internal parts of the unit.

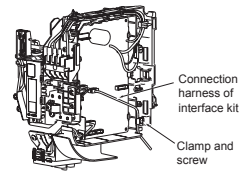

### 15. PUMP DOWN WORK

For the environmental protection, be sure to pump down when relocating or disposing of the unit. Pump down is the method of recovering refrigerant from the indoor unit to the outdoor unit before the connecting pipes are removed from the unit. When pump down is carried out, forced cooling operation is needed.

#### Forced cooling operation

- (1) Turn off the power source and turn it on again after 1 minute.
- (2) Press the ON/OFF button continuously for at least 5 seconds. Then operation will start.

For the detail of pump down, refer to the installation manual of outdoor unit.

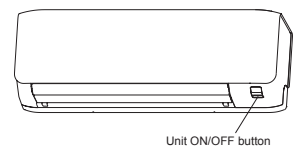

### 16. INSTALLATION CHECK AND TEST RUN

After finishing the installation work, check the following points again before turning on the power. Conduct a test run and ensure that the unit operates properly. At the same time, explain to the customer how to use the unit and how to take care of the unit following the user's manual.

#### Before test run

Before test run, check following points.

Power source voltage complies with the rated voltage of air-conditioner.	
Earth leakage breaker and circuit breaker are installed.	
Power cable and connecting cable are securely fixed to the terminal block.	
Both liquid and gas service valves are fully open.	
No gas leaks from the joints of the service valves.	
Indoor and outdoor side pipe joints have been insulated.	
Hole on the wall is completely sealed with putty.	
Drain hose and cap are installed properly.	
Screw of the lid is tightened securely.	

#### Test run

Check following points during test run.

Indoor unit receives signal of remote control.	
Air-conditioning operation is normal.	
There is no abnormal noise.	
Water drains out smoothly.	
Display of remote control is normal.	

#### After test run

Explain the operating and maintenance methods to the user according to the user's manual.	
Keep this installation manual together with user's manual.	

#### NOTE

During restart or change in operation mode, the unit will not start operating for approximately 3 minutes. This is to protect the unit and it is not malfunction.